



created by agrof2015



free instruction
class1 unlimited buggy

- 9x 15
- 2x 15
- 1x 15
- 4x 13
- 12x 11
- 5x 9
- 4x 9
- 5x 7
- 2x 7
- 2x 5

- 1x 3
- 2x 3
- 4x 3
- 3x 3
- 4x 6
- 2x 6
- 4x 3
- 6x 3
- 4x 3













- 1x 3
- 2x 3
- 2x 3
- 2x 3
- 3x 3
- 6x 3
- 14x 3
- 2x 3
- 4x 3







- 1x 3
- 8x 3
- 2x 3
- 2x 3
- 4x 3
- 3x 3
- 2x 3
- 1x 3
- 4x 3
- 2x 3

- 2x 3
- 4x 3
- 4x 3
- 2x 3
- 8x 3
- 4x 3
- 3x 3
- 4x 3
- 2x 3
- 1x 3

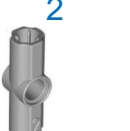
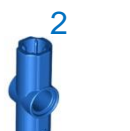
8x 
1x 
2x 
2x 
4x 
4x 
4x 
1x 
1x 
1x 
1x











4x 
10x 
2x 
11x 
157x 
4x 
59x 
1x 
77x 
2x 
6x 
3x 

8x 
31x 
27x 
4x 
12x 
2x 
1x 
1x 
2x 
2x 
6x 
6x 

4x 
3x 
2x 
7x 
2x 
2x 
1x 
2x 
2x 

2x 
2x 
1x 
12x 
2x 
2x 
2x 
5x 
2x 

2x 
2x 
2x 
3x 
2x 
4x 
3x 
10x 
6x 

33x 
2x 
13x 
8x 
11x 
3x 
4x 
4x 
2x 
4x 

- 2x
- 2x
- 4x
- 8x
- 2x
- 4x
- 1x
- 4x

- 1x
- 2x
- 5x
- 2x
- 2x
- 4x
- 6x
- 1x
- 2x

- 1x
- 4x
- 10x
- 2x
- 1x
- 2x
- 1x
- 1x

- 1x
- 1x
- 2x
- 2x
- 2x
- 2x
- 6x
- 1x
- 3x
- 1x

- 2x
- 5x
- 1x
- 2x
- 2x
- 4x
- 4x
- 4x



RC4WD 1.55 Mud Thrashers

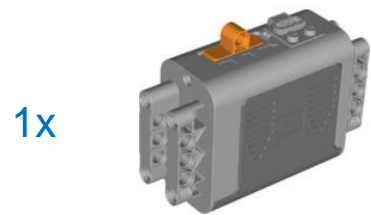

11



1x



1x



1x



2x

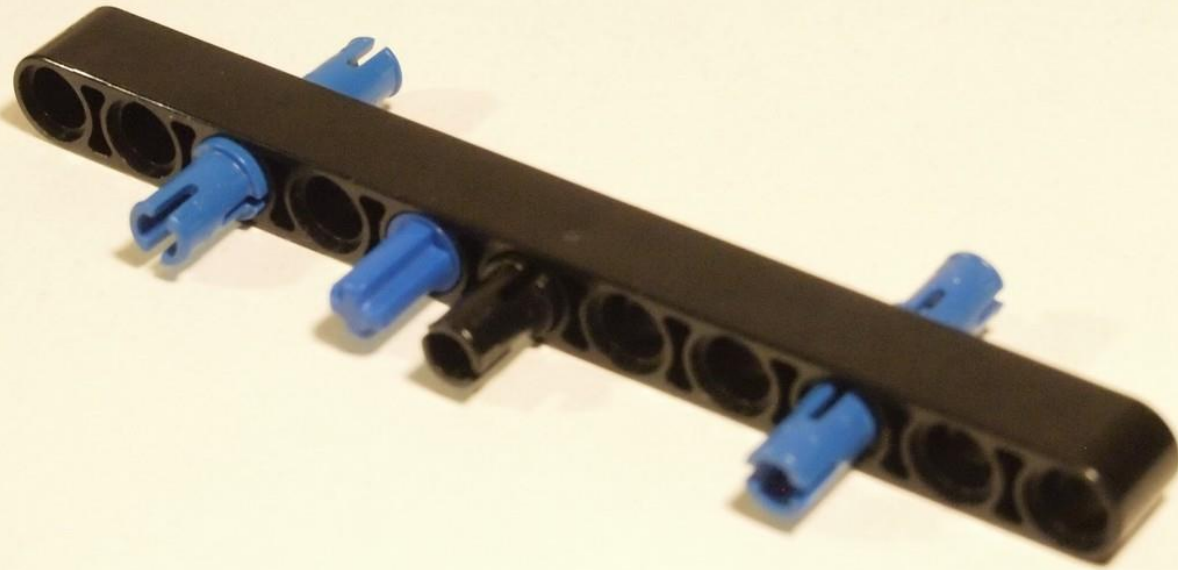



1x



1x

13

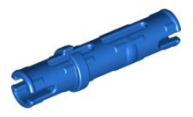

1x

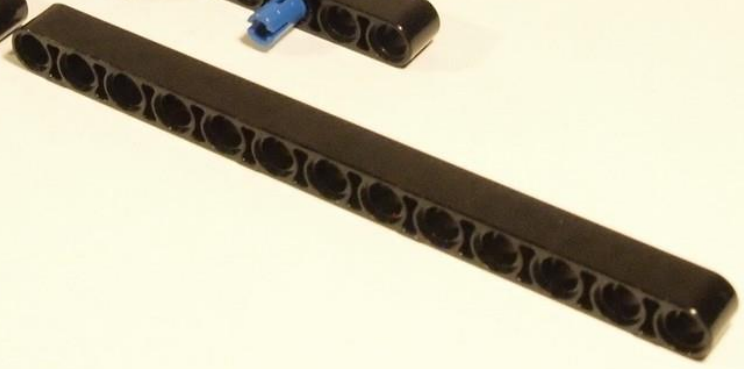



1x



2x



1x



2x

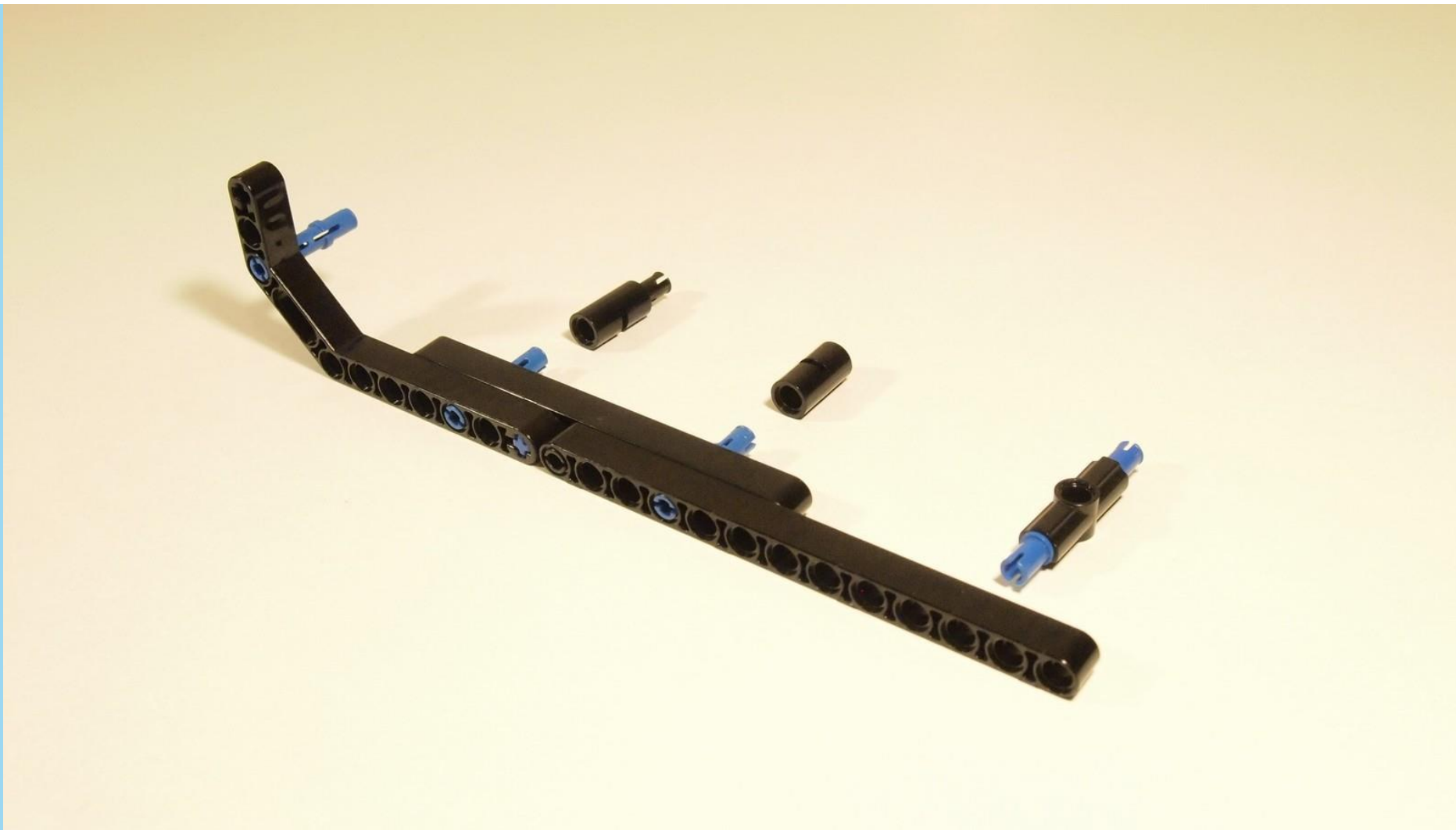

15



1x



2x



1x

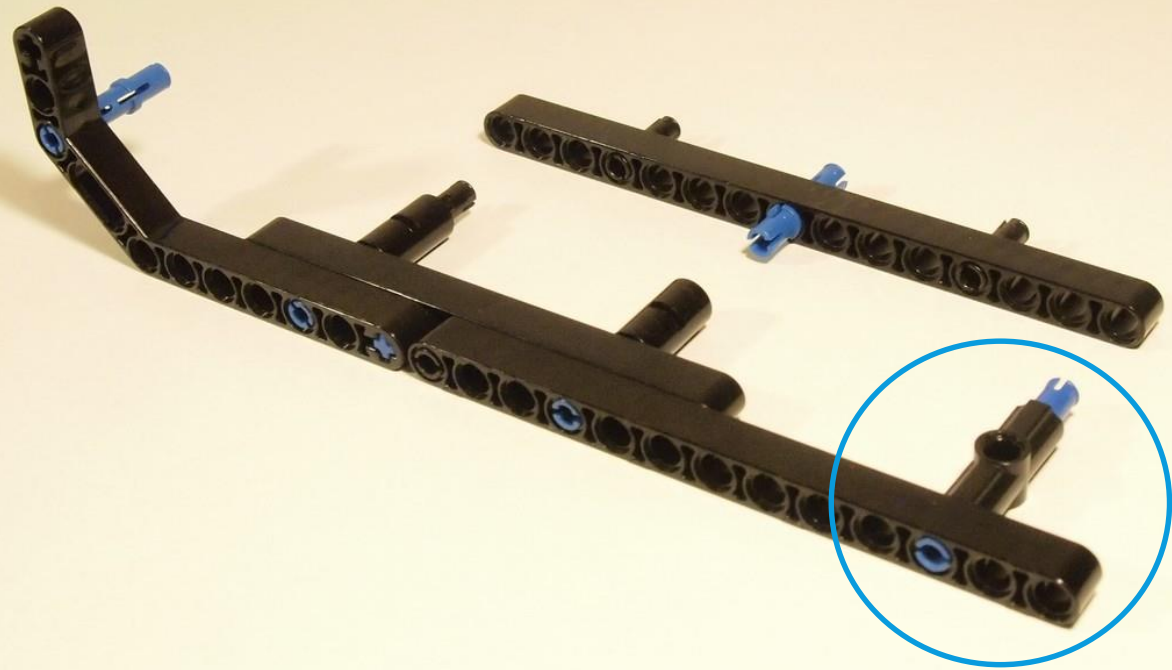

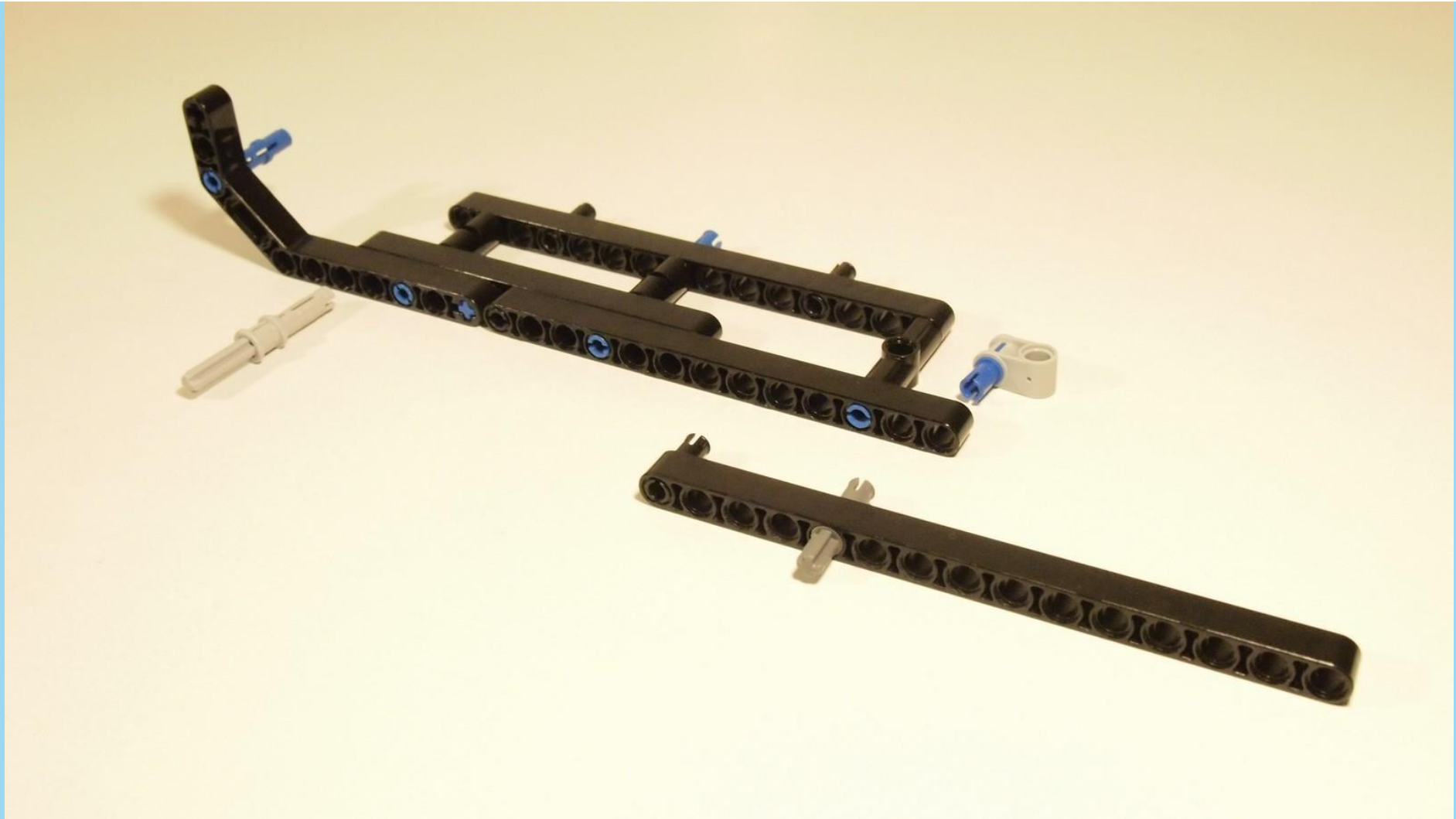

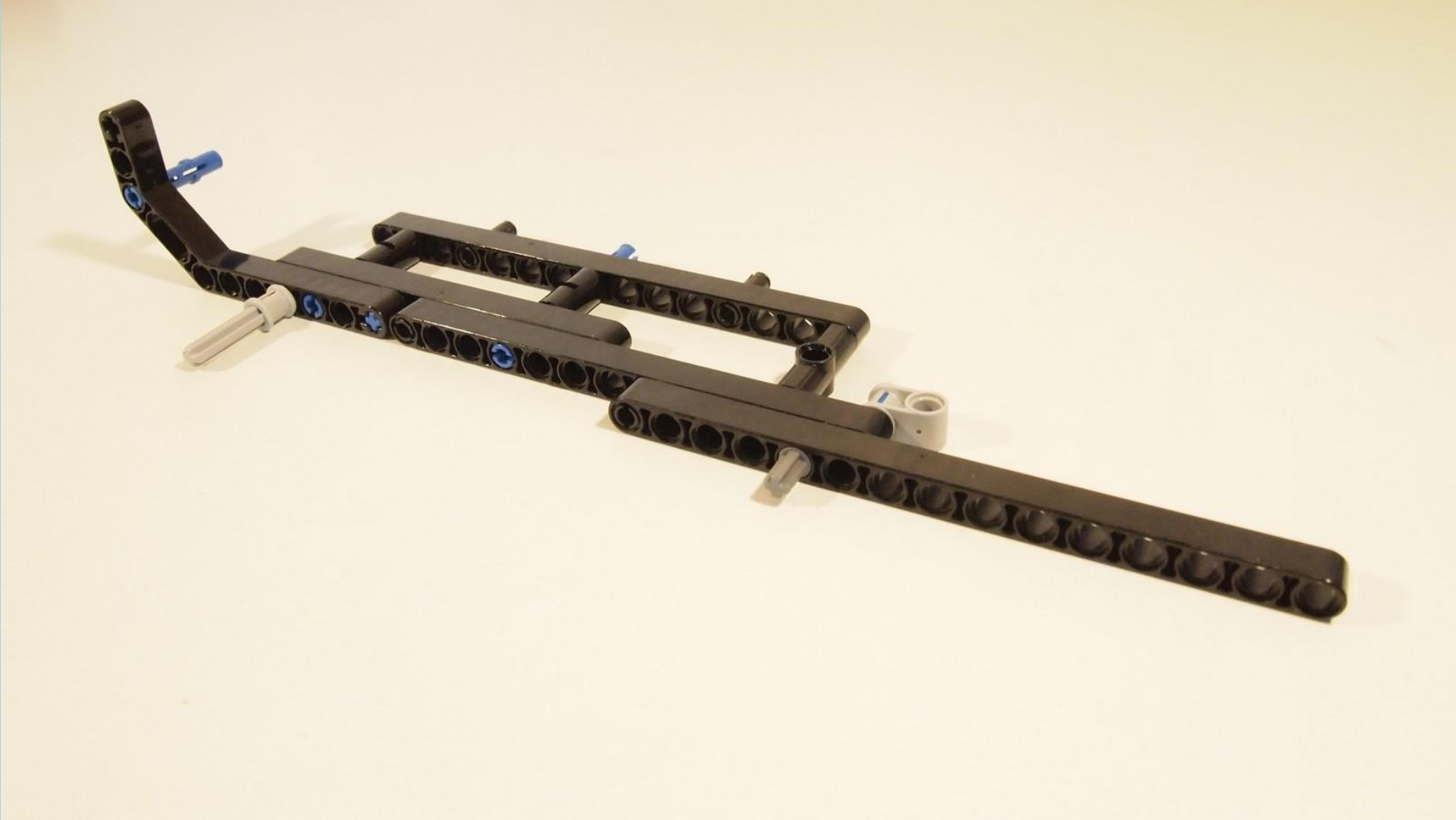

7



3x



1x



2x

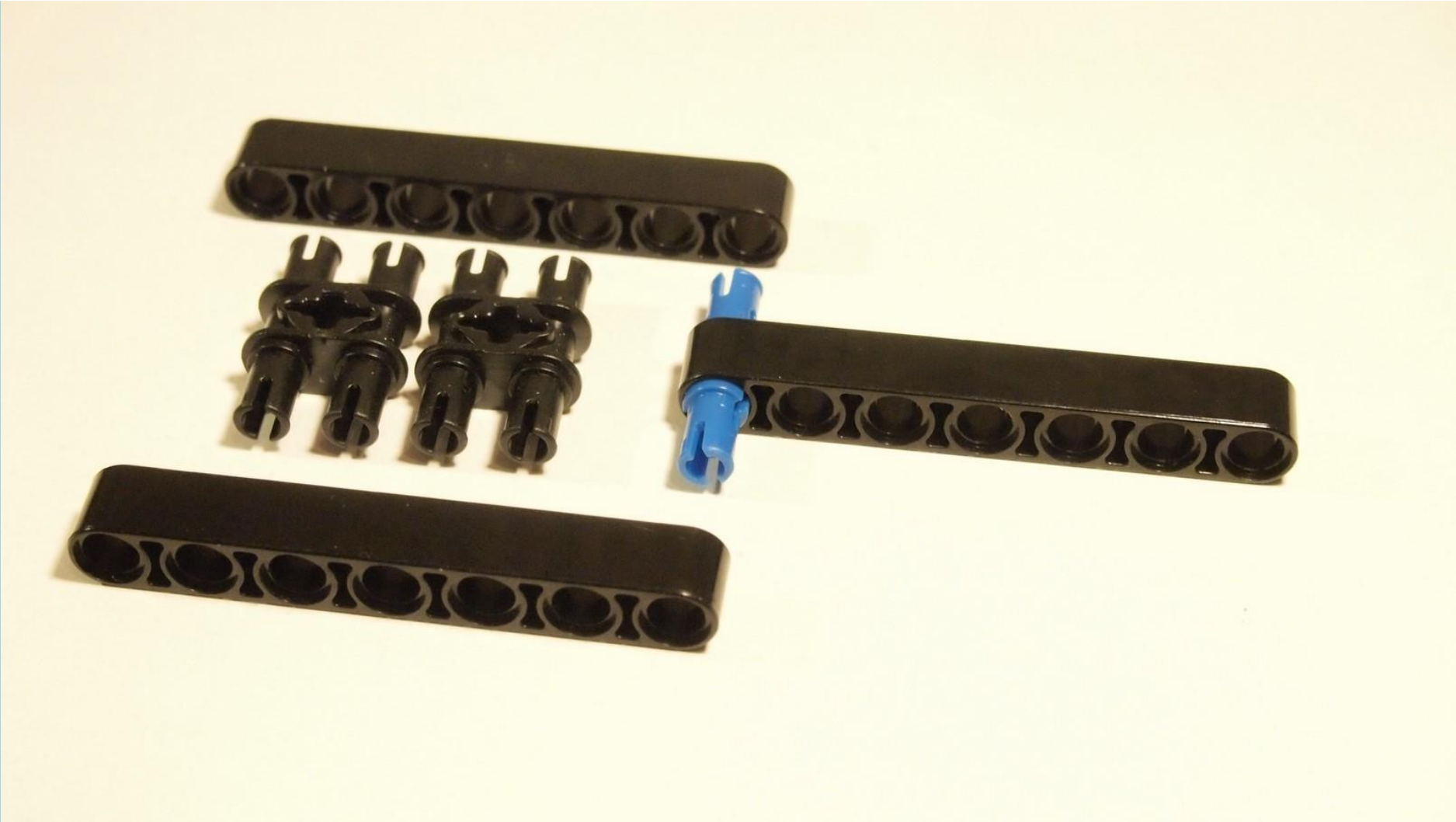

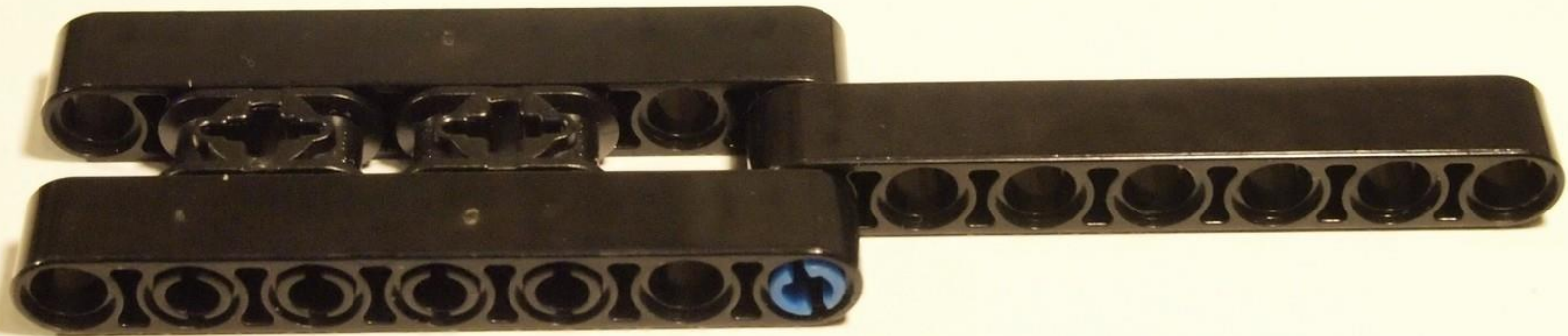



1x



3x

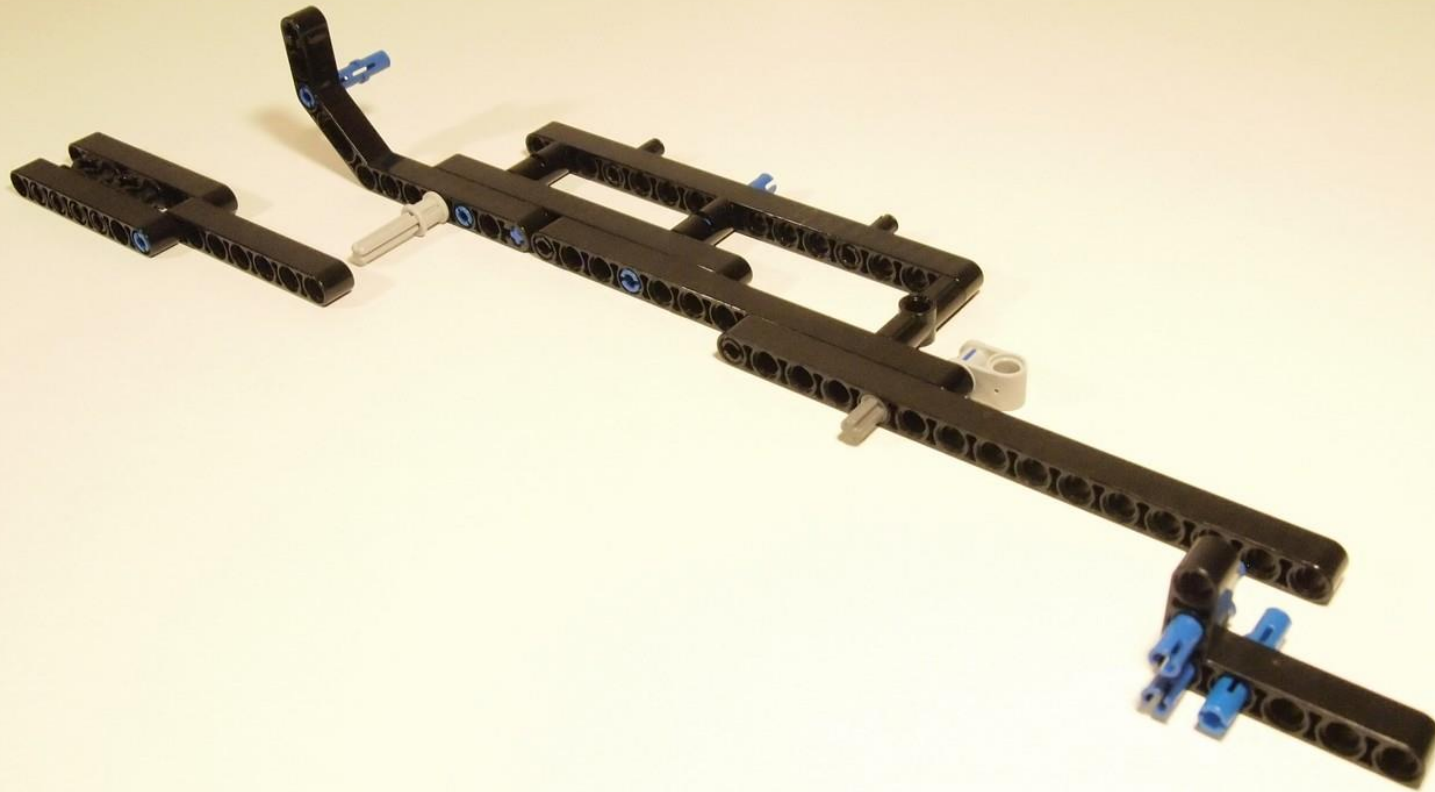

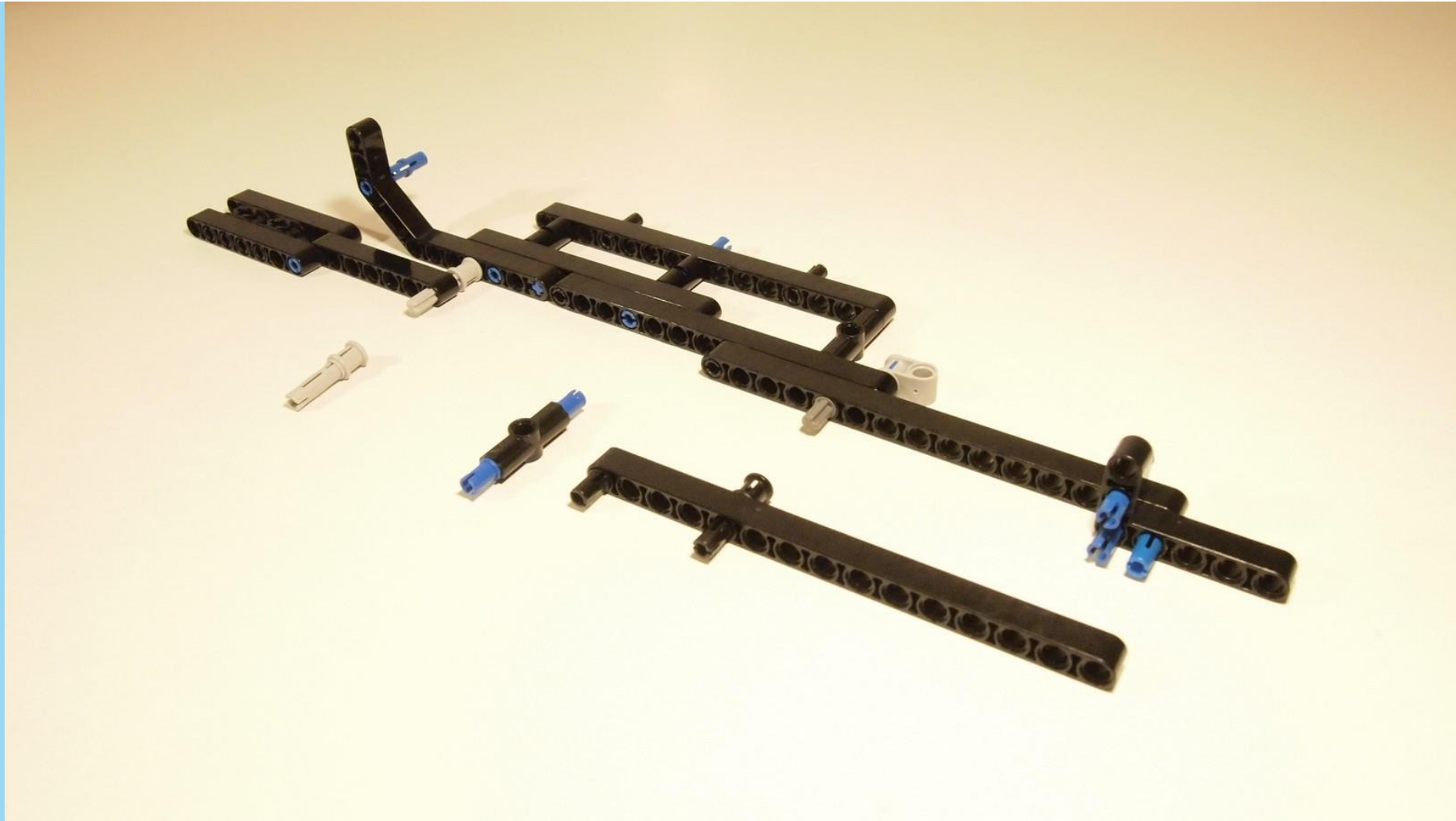
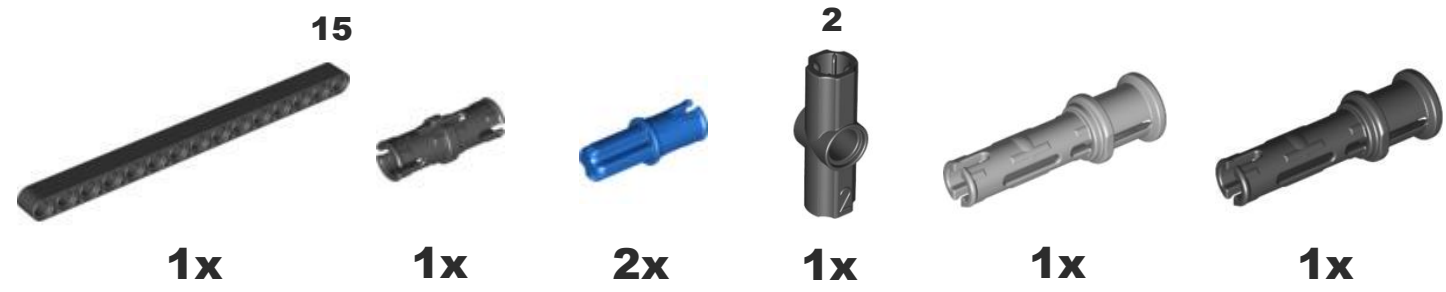



1x



13

1x



1x



1x



3x

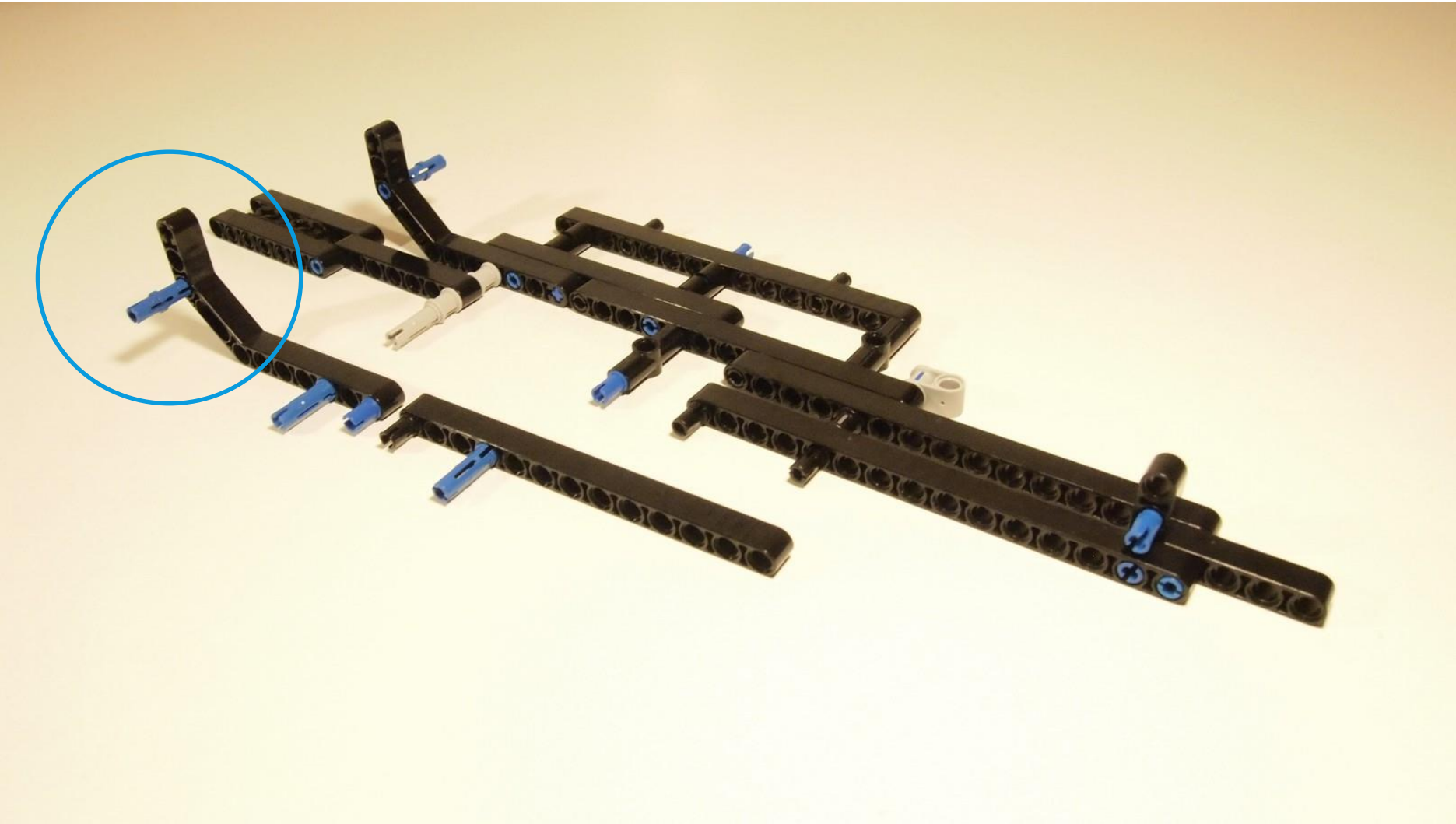

11



1x

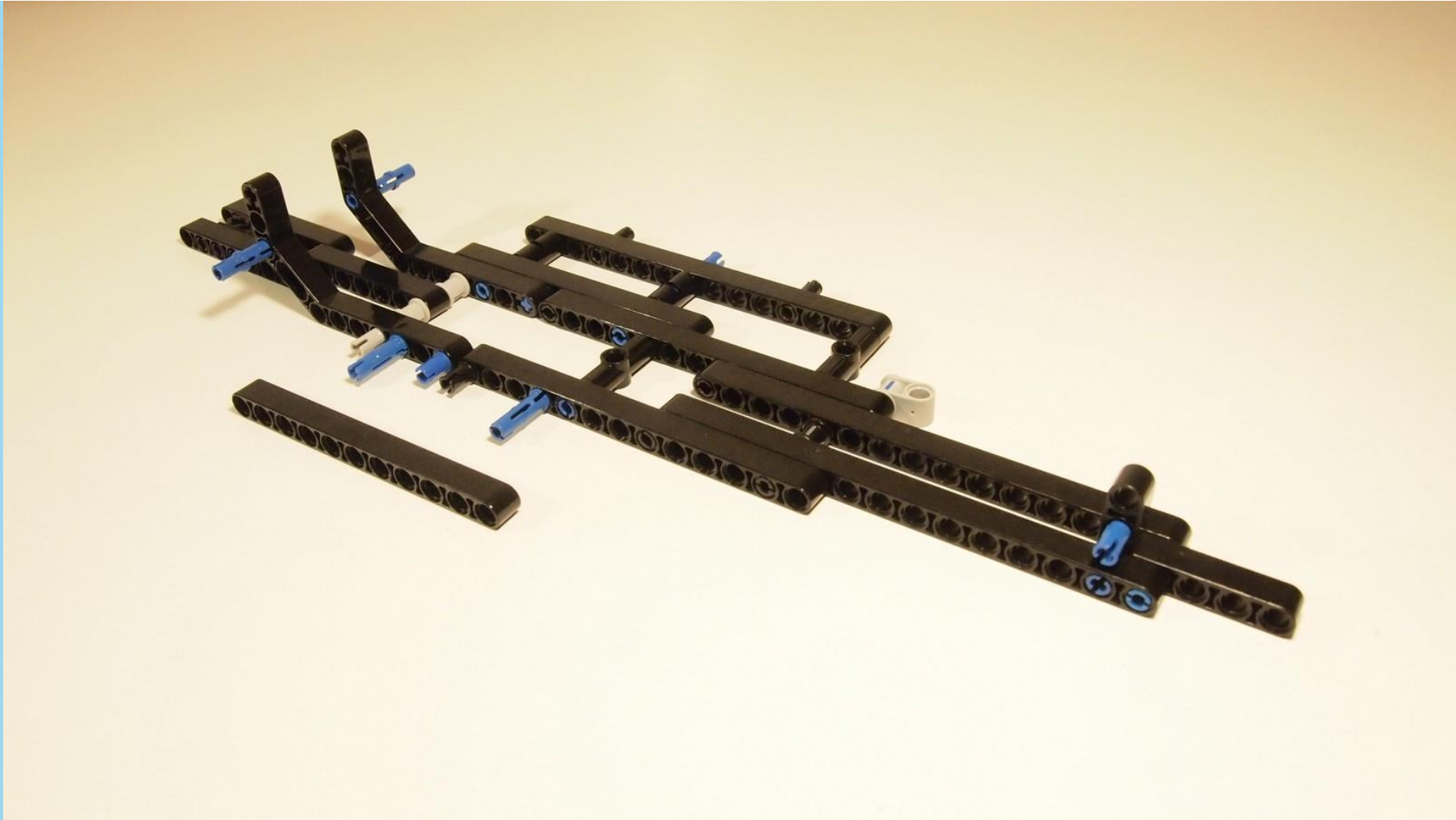



1x



3x



1x



2x

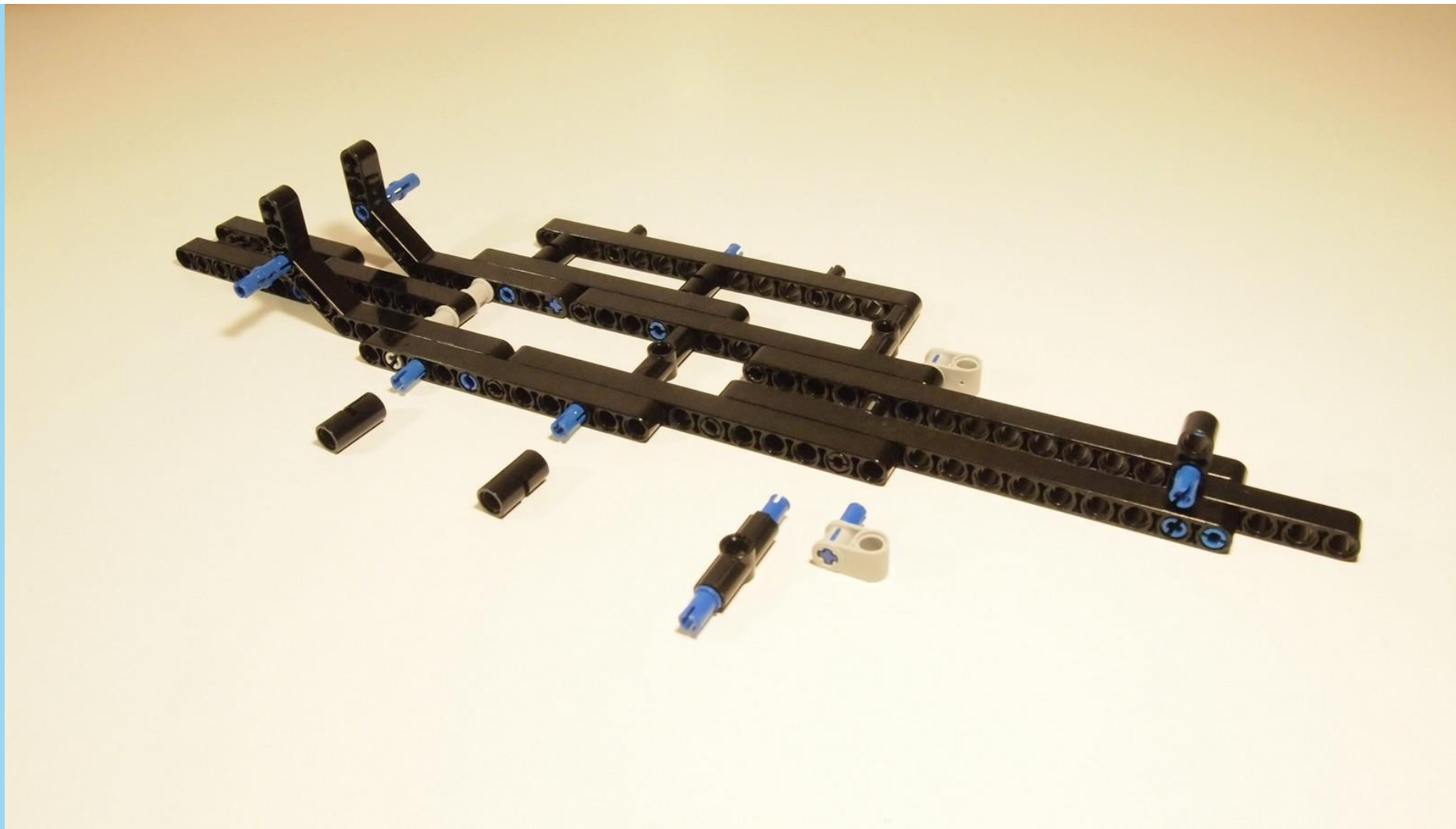

15



1x



3x

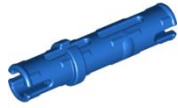

1x

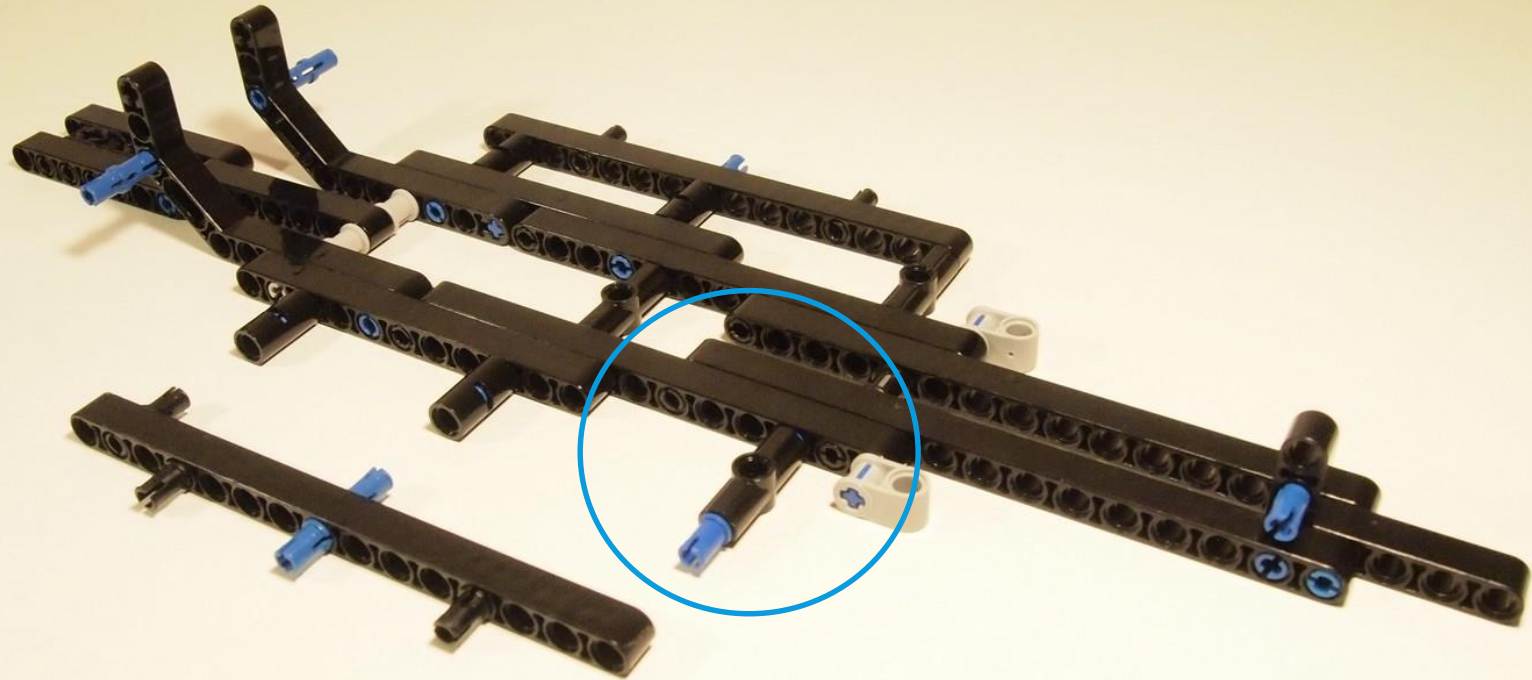

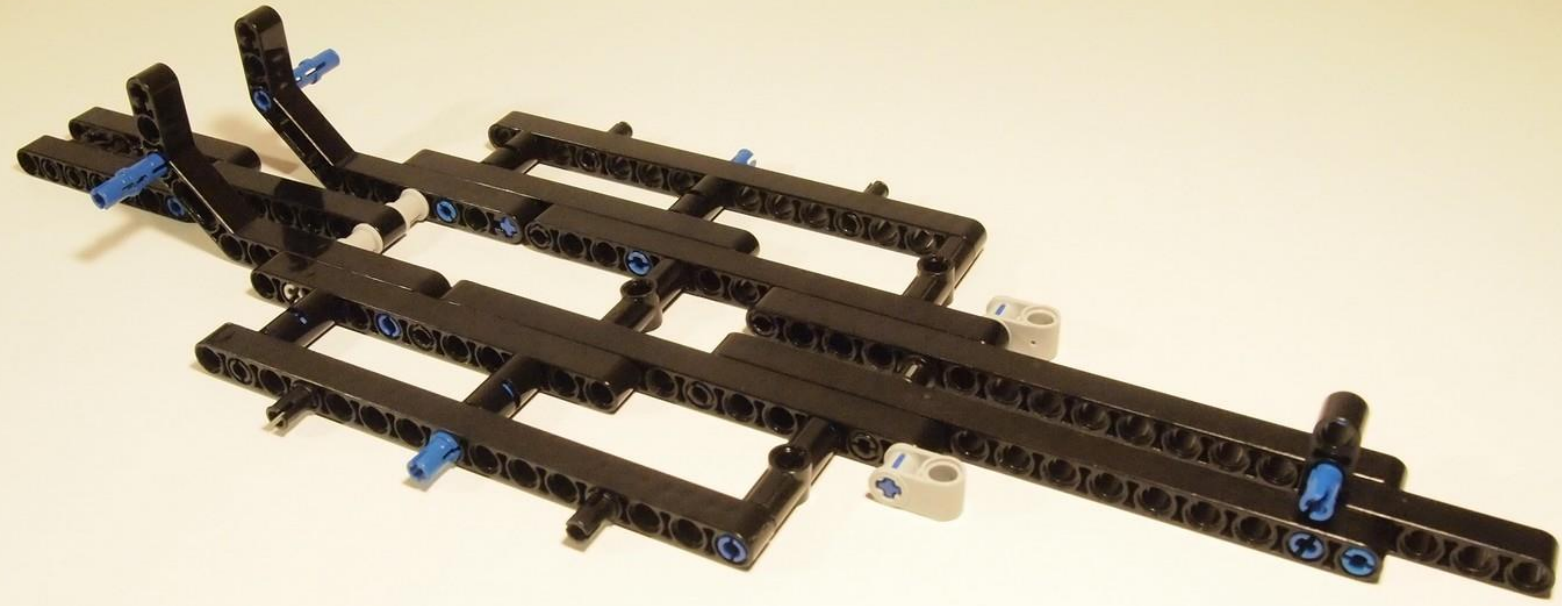

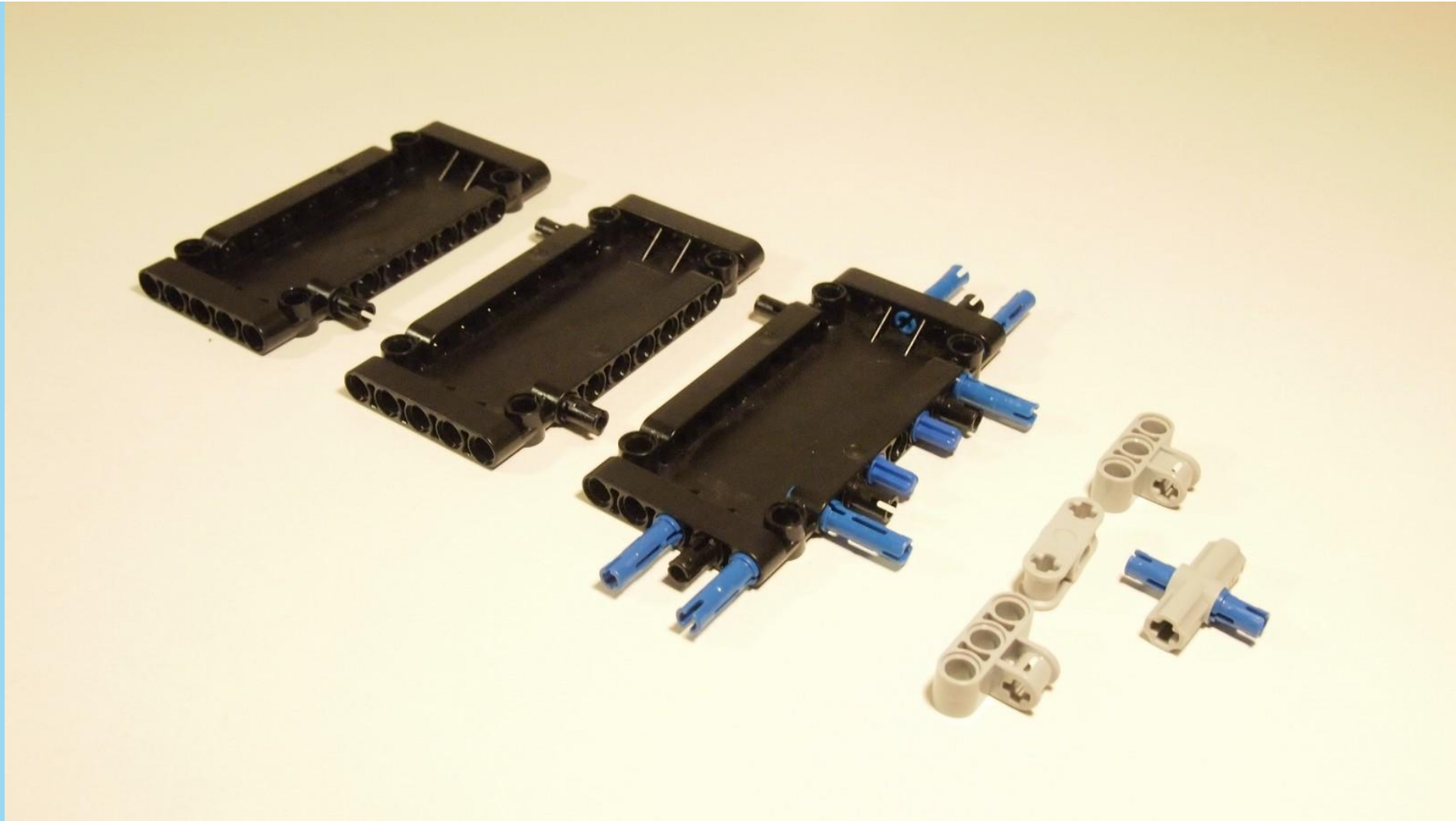
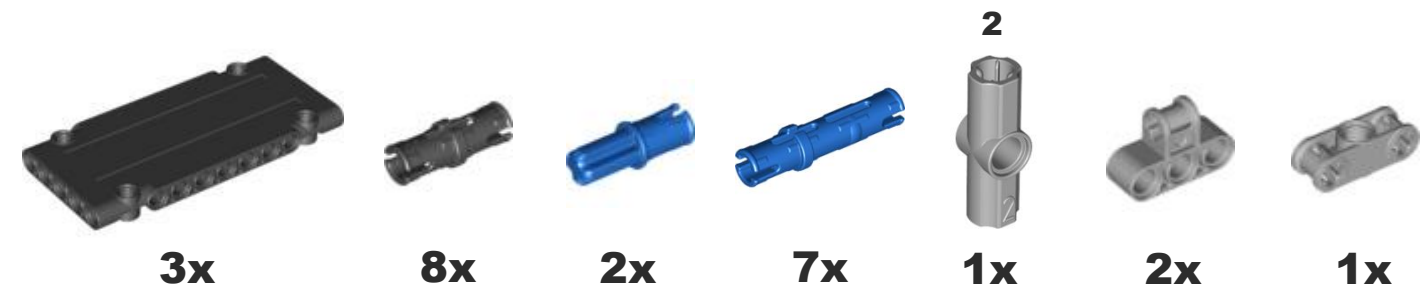

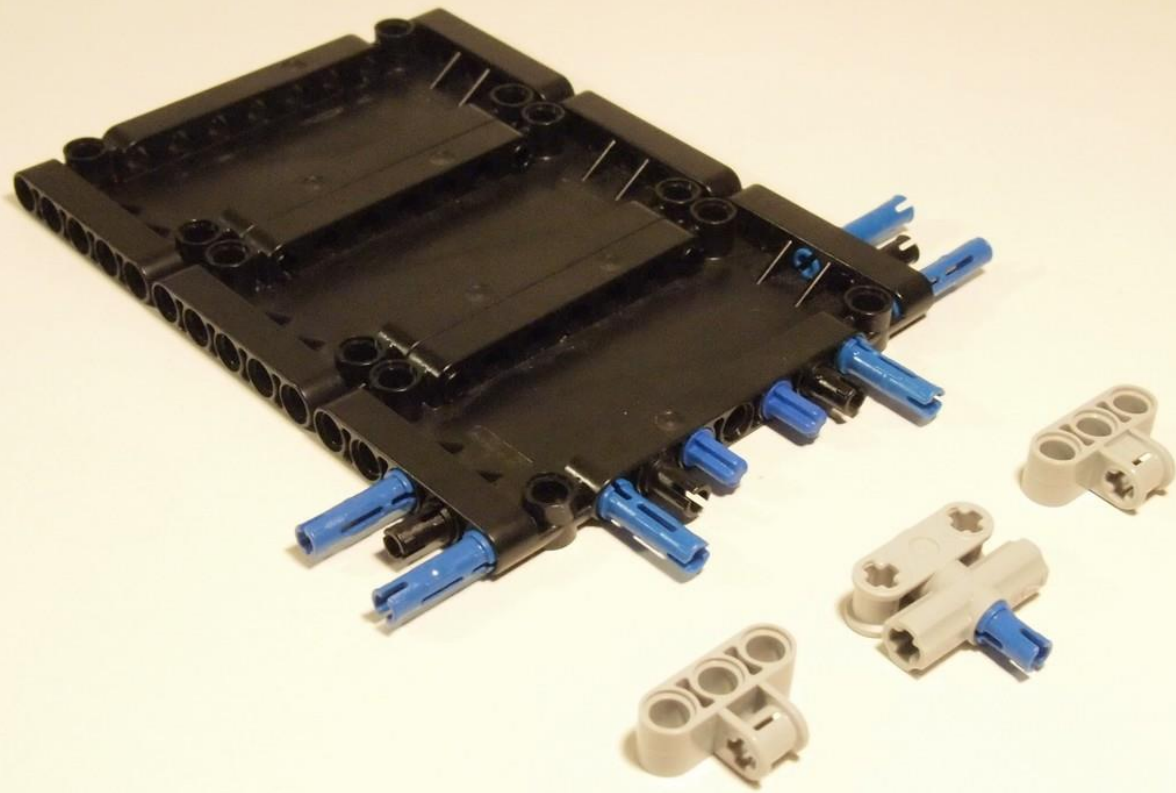



2x



2x

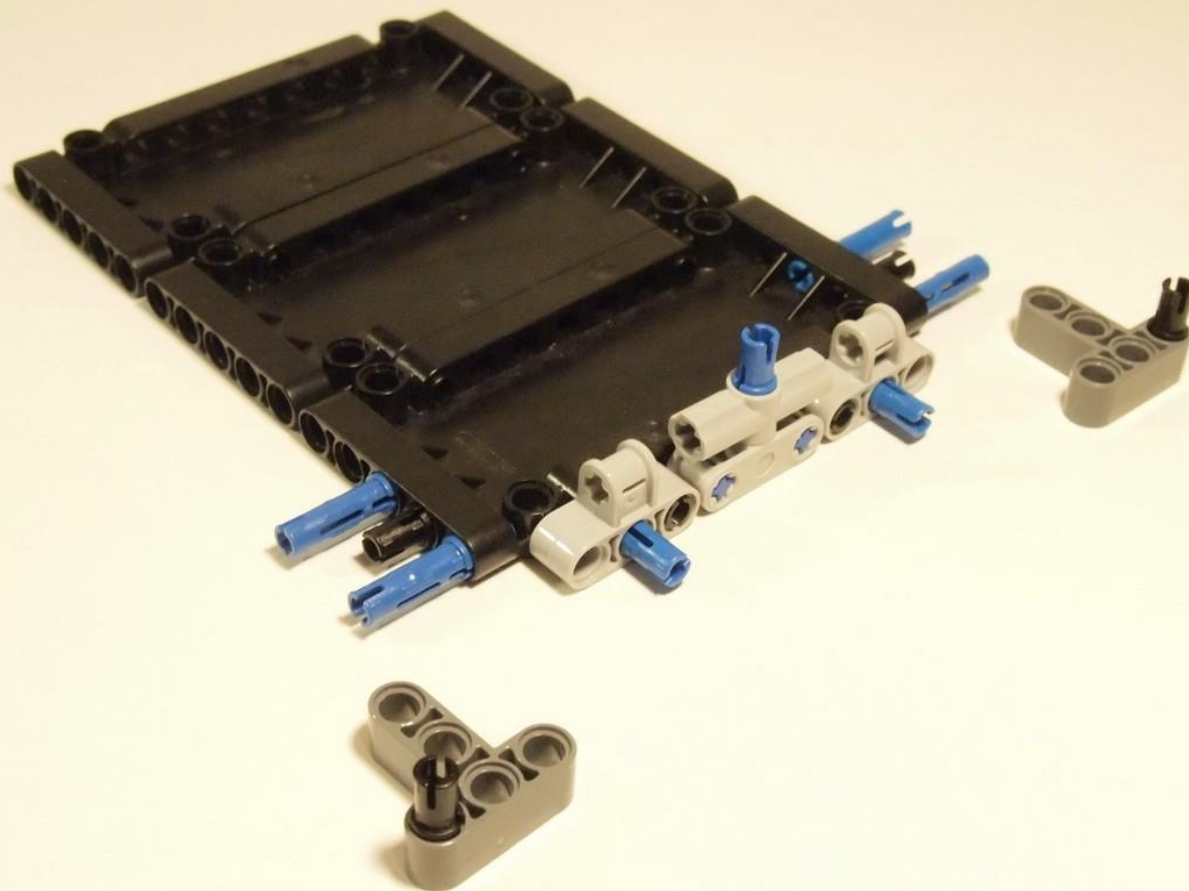

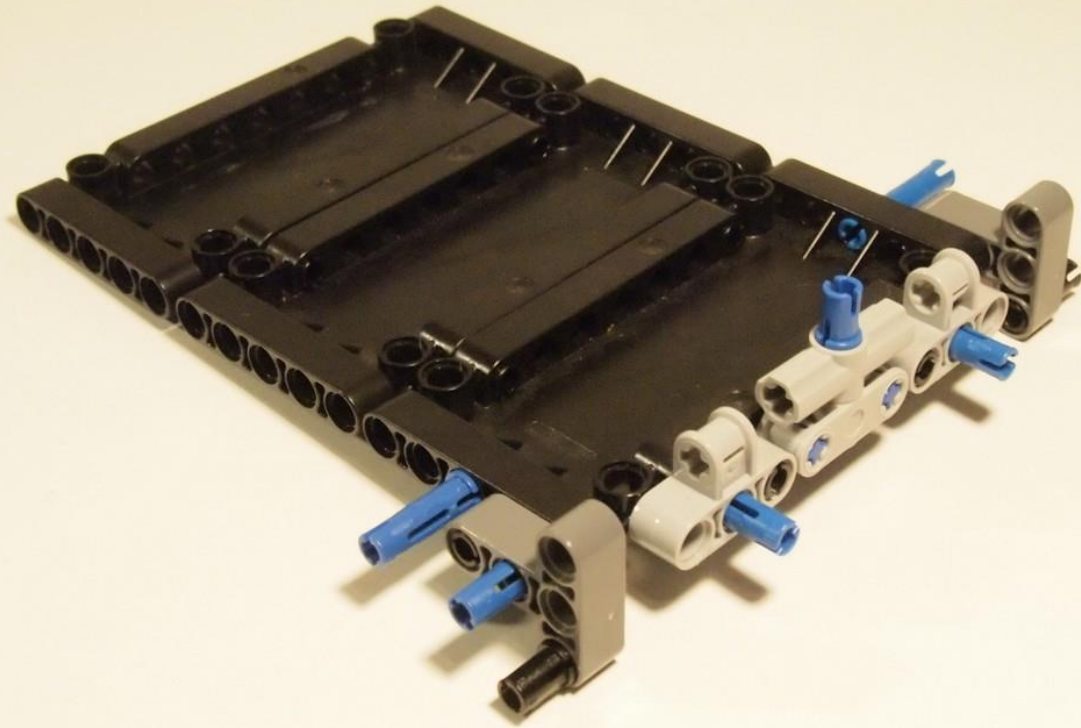

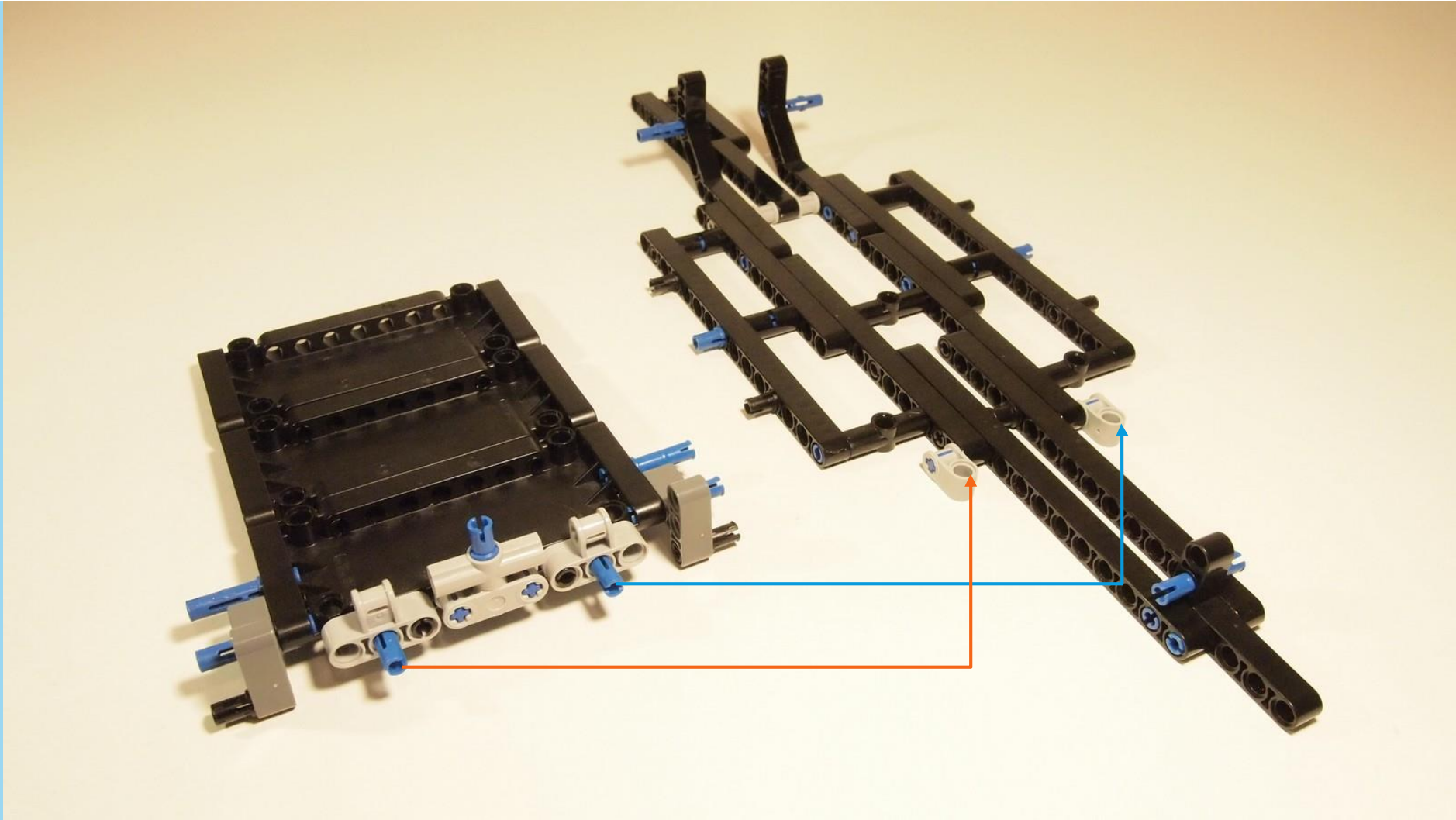

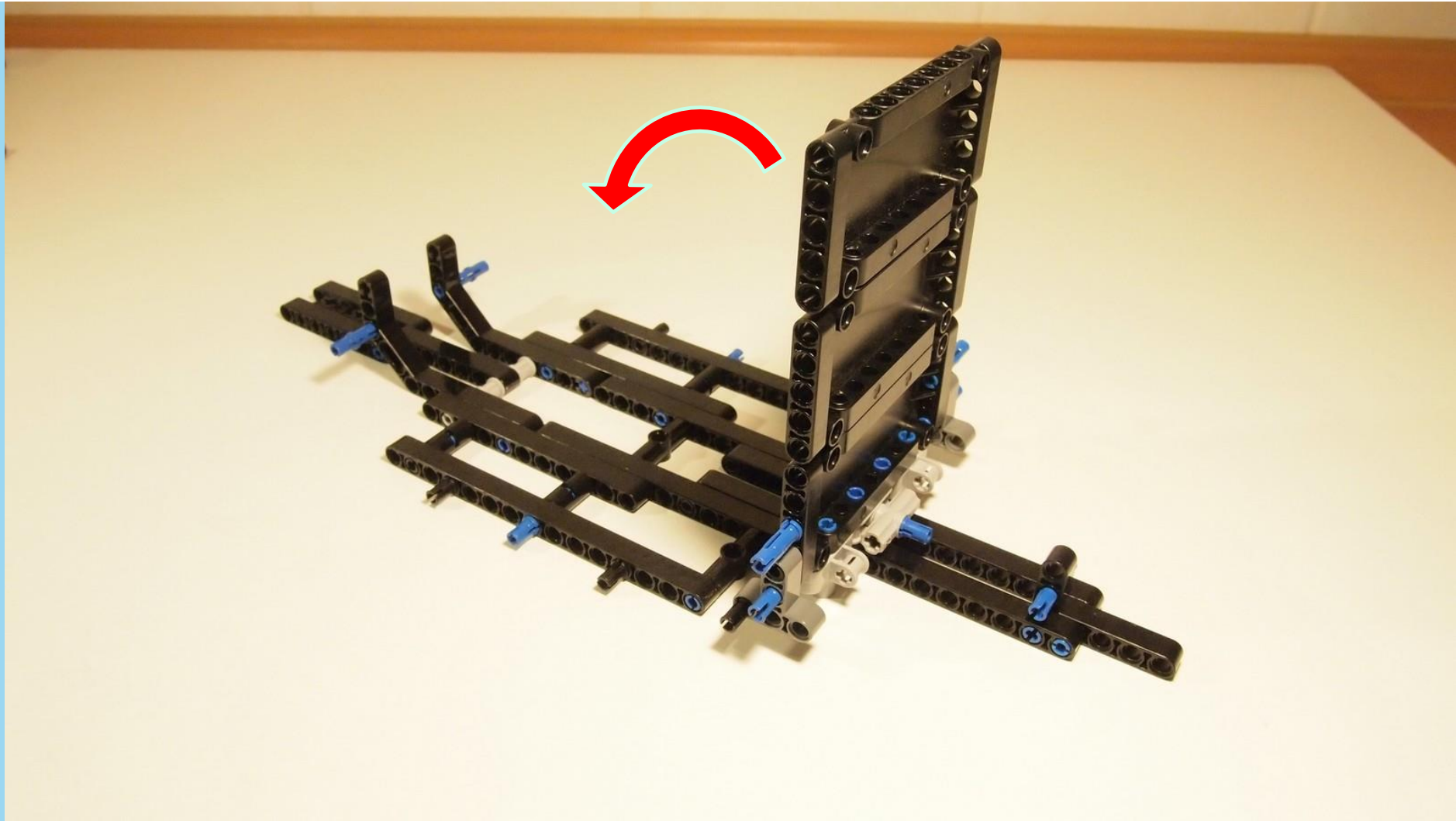

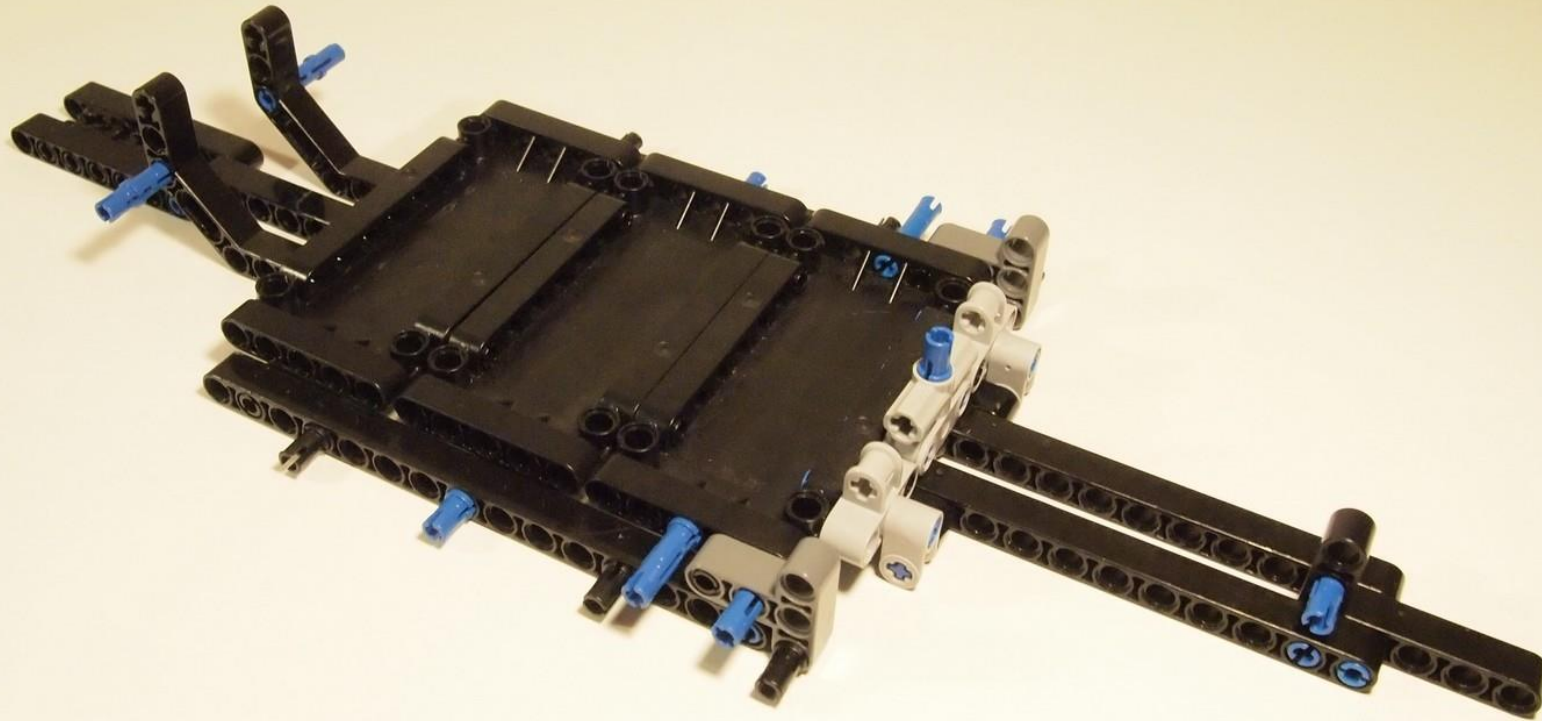



1x



1x



2x



1x



1x



1x



2x

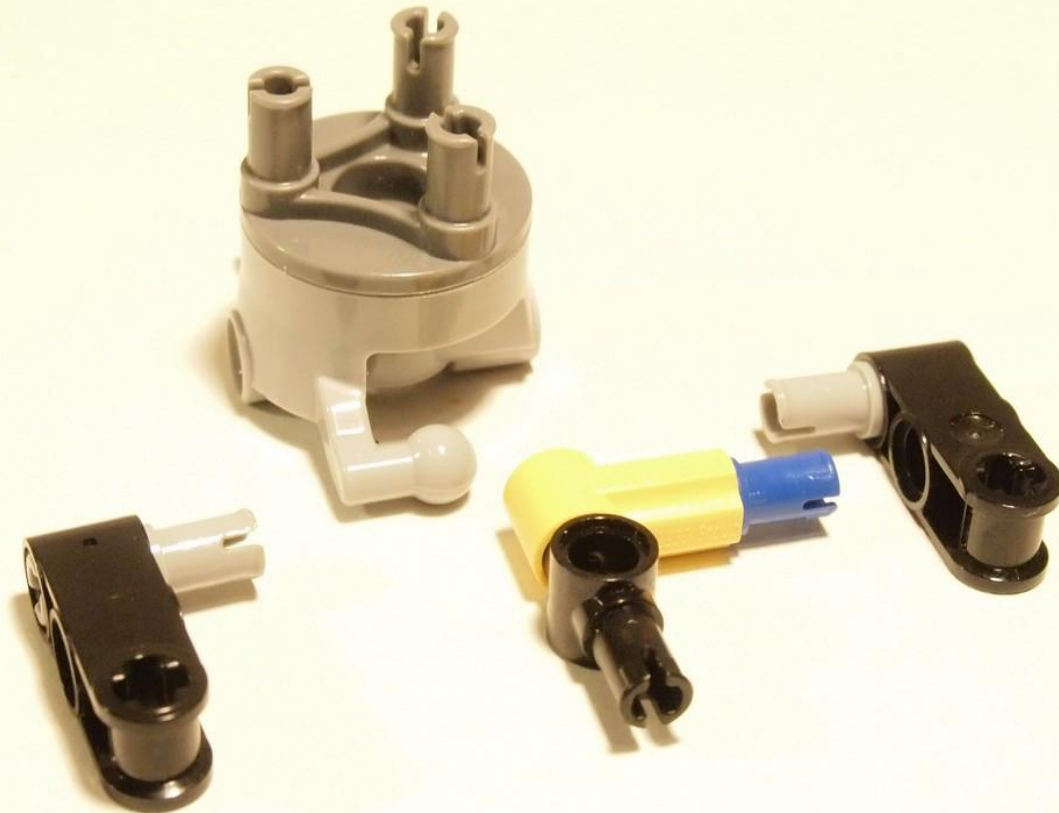





2x



1x



4

2x



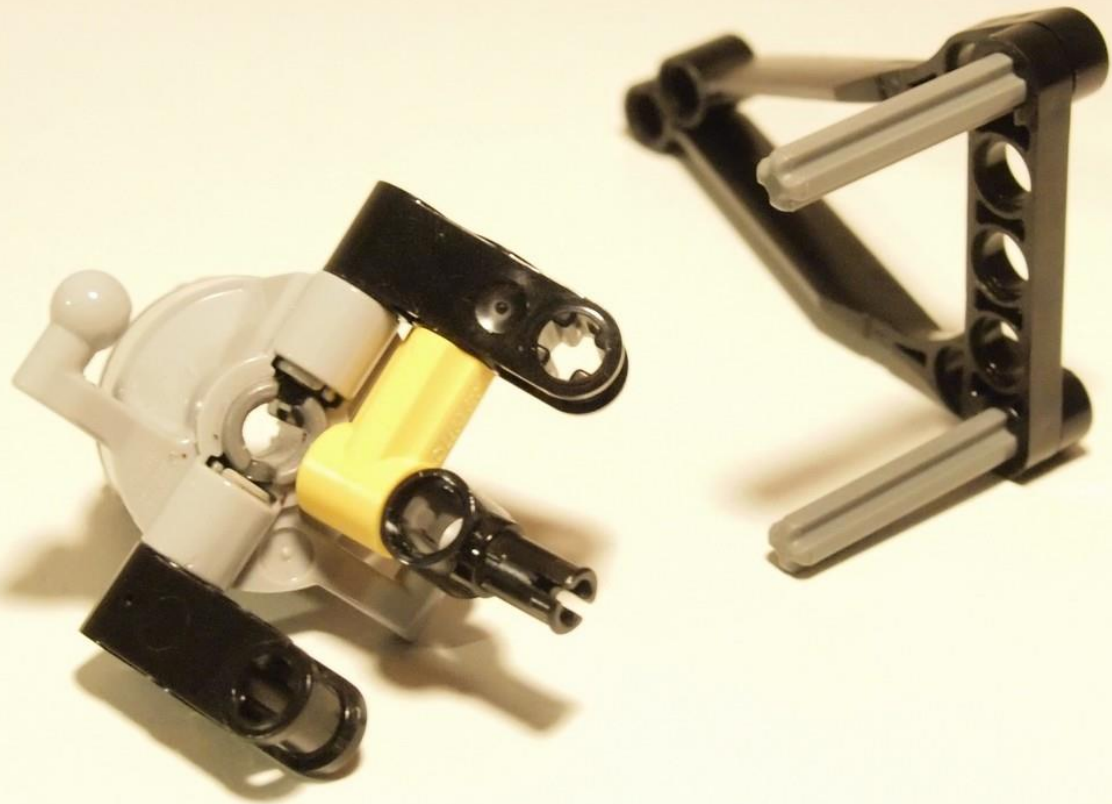



1x

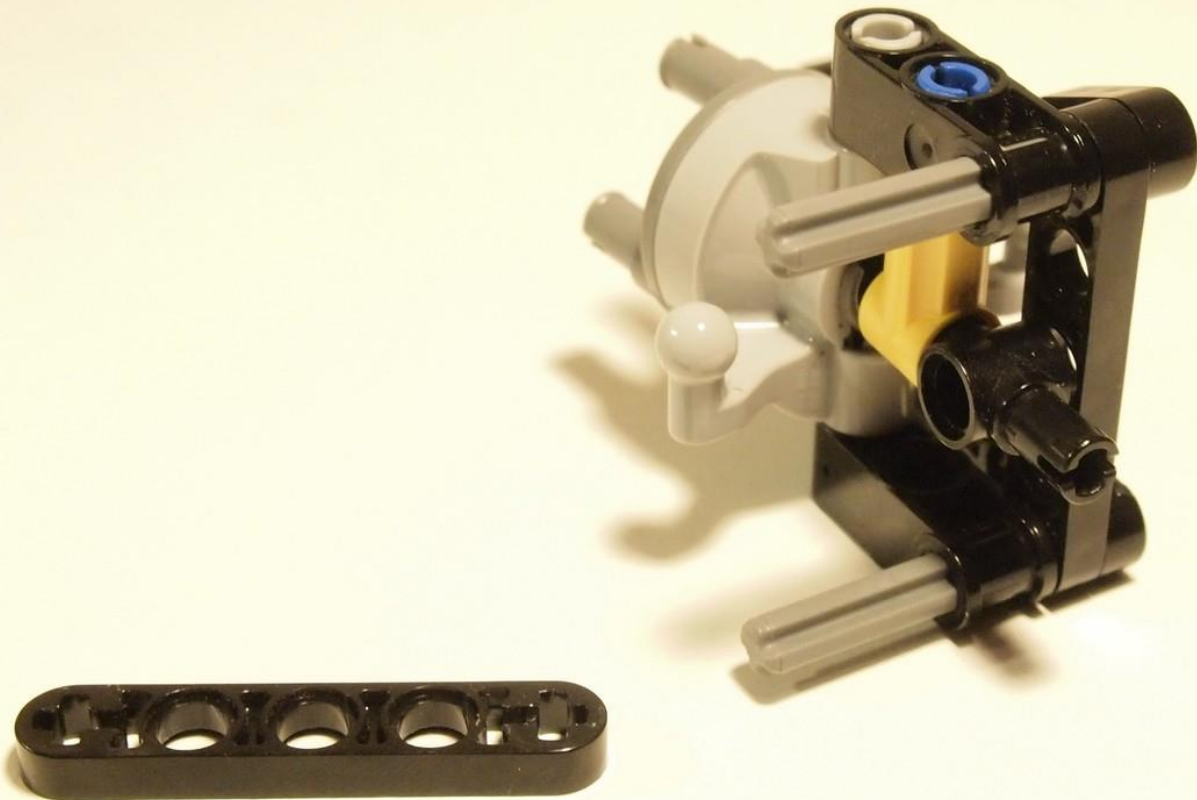



1x

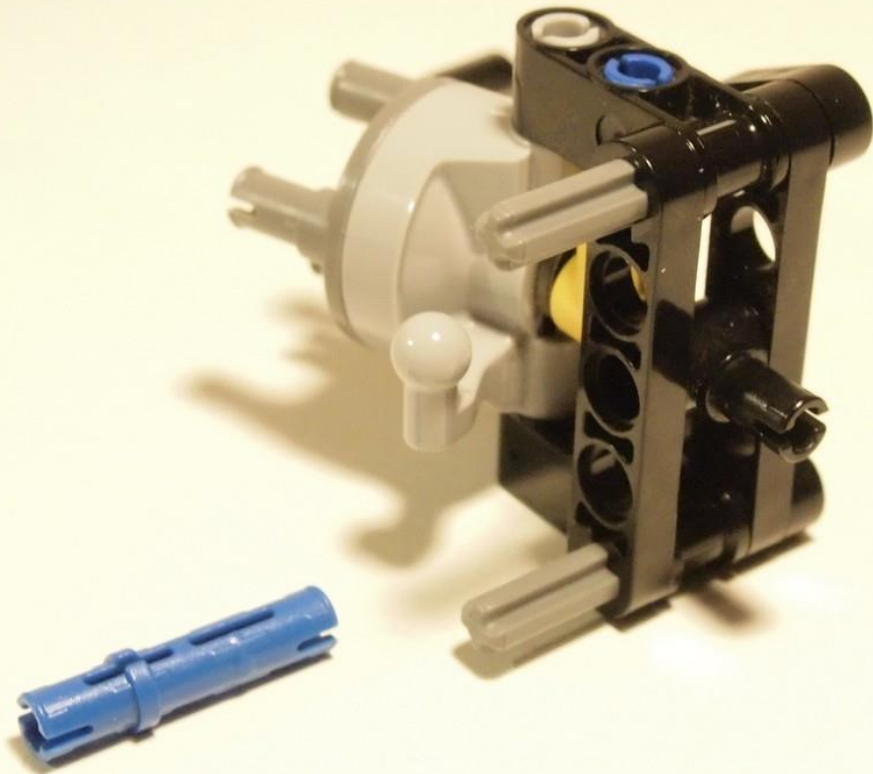

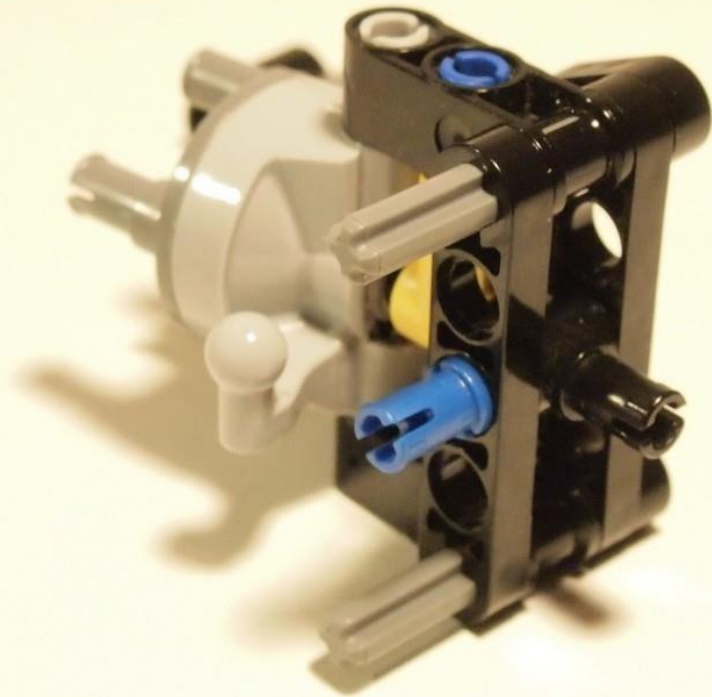



2x



1x



1x

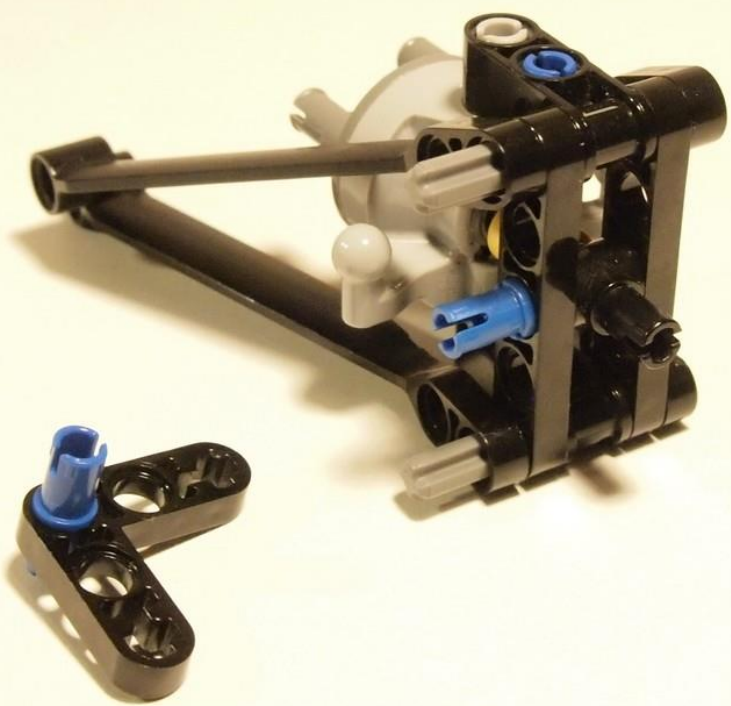



1x

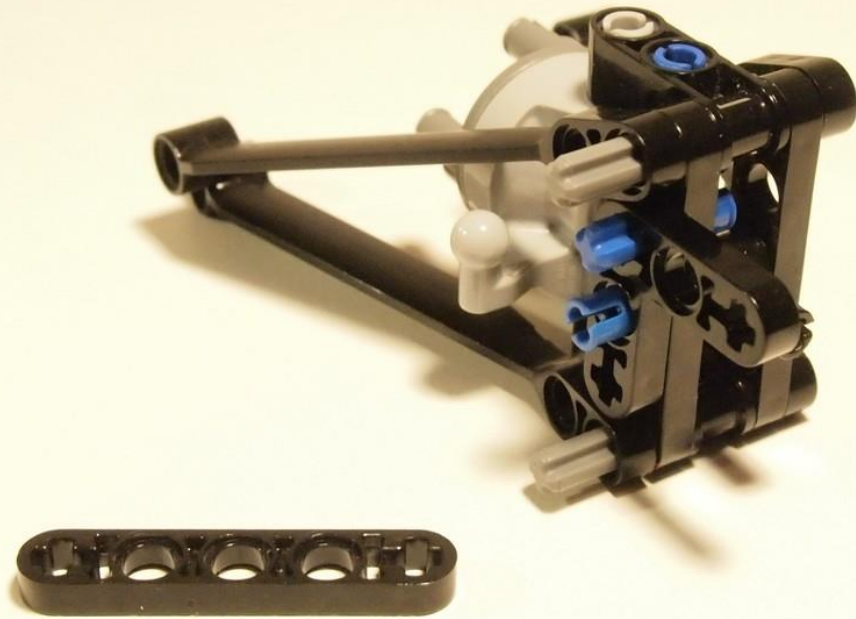

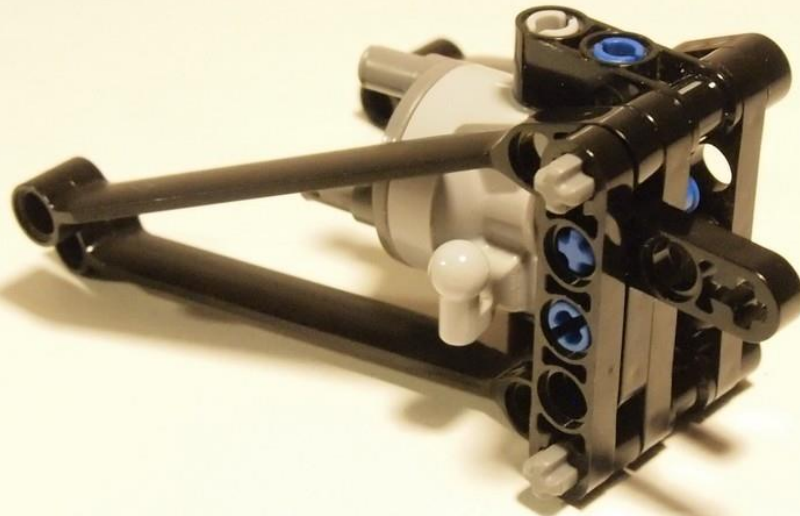



3x





1x



1x



1x





1x



1x



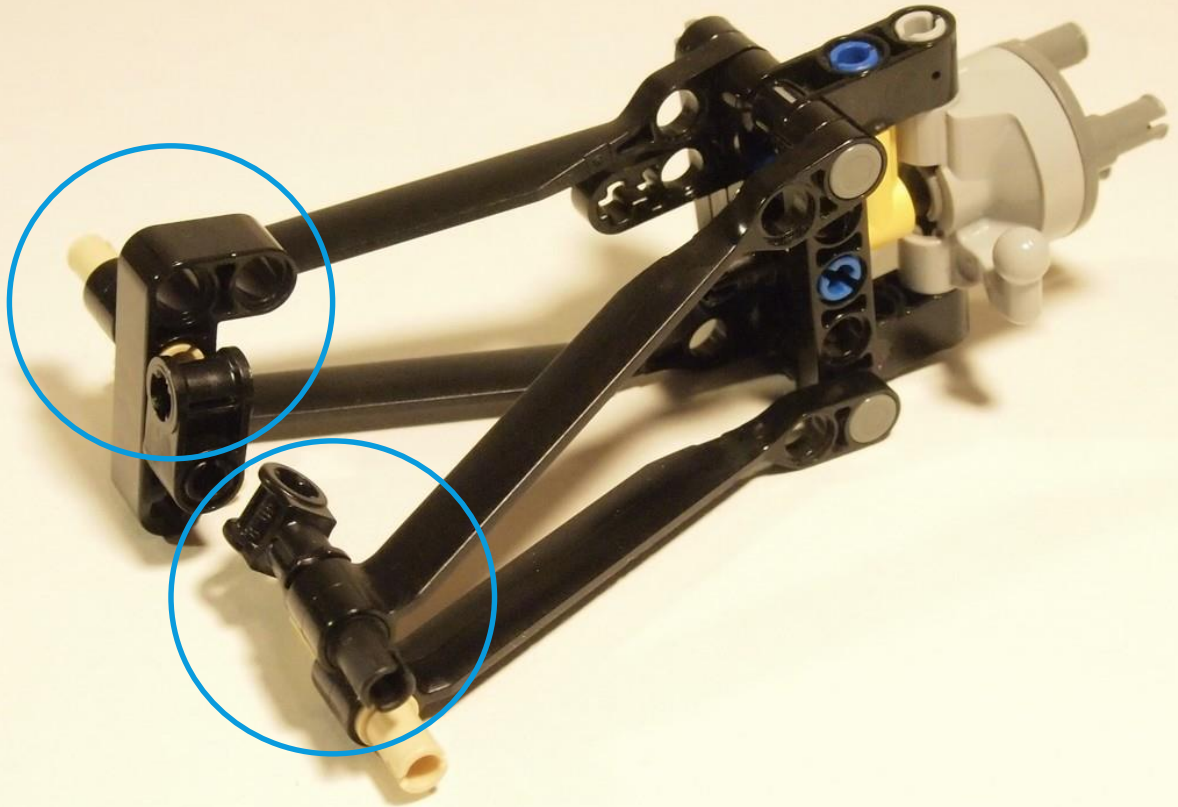



1x



1x



2x



1x



1x



1x



2x

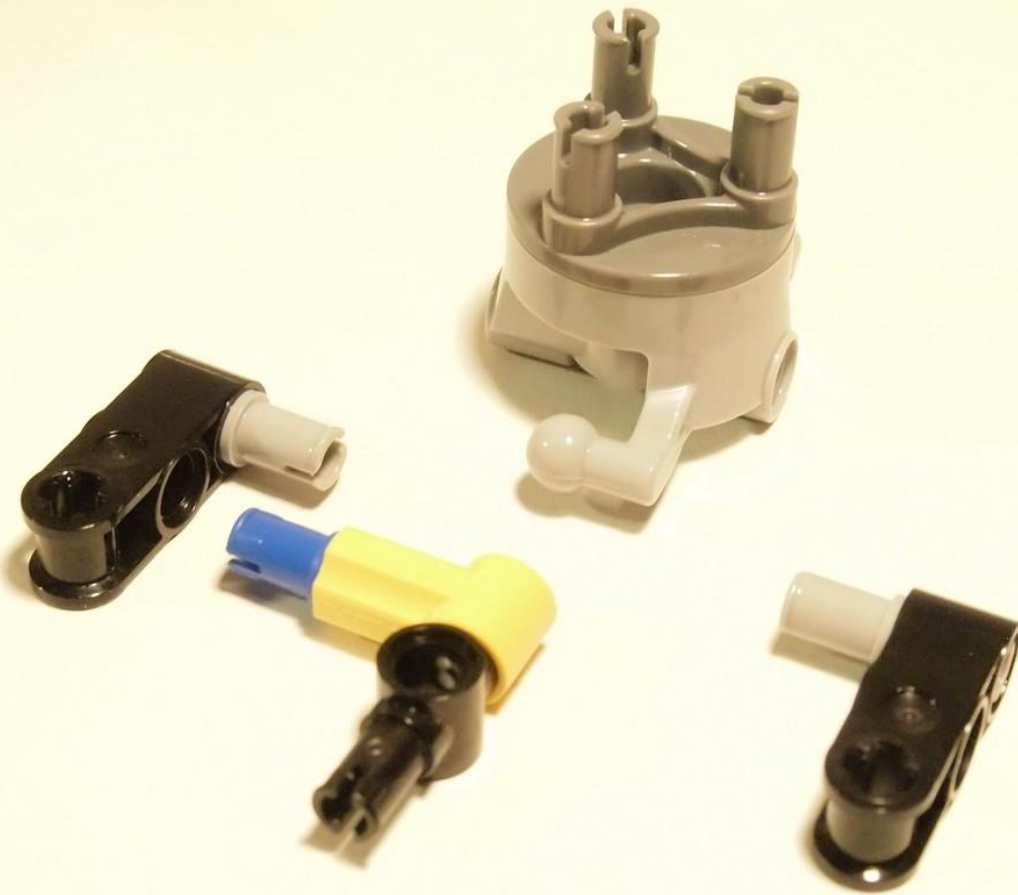

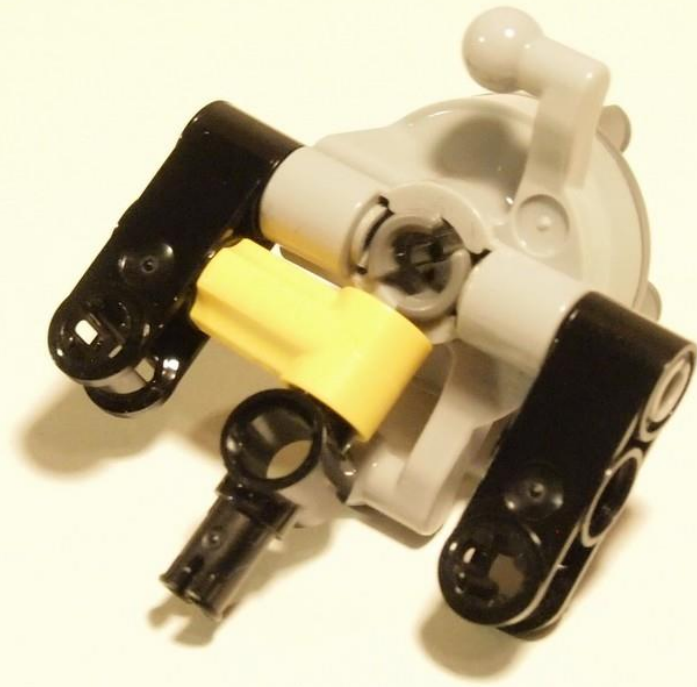



2x



1x



2x

4



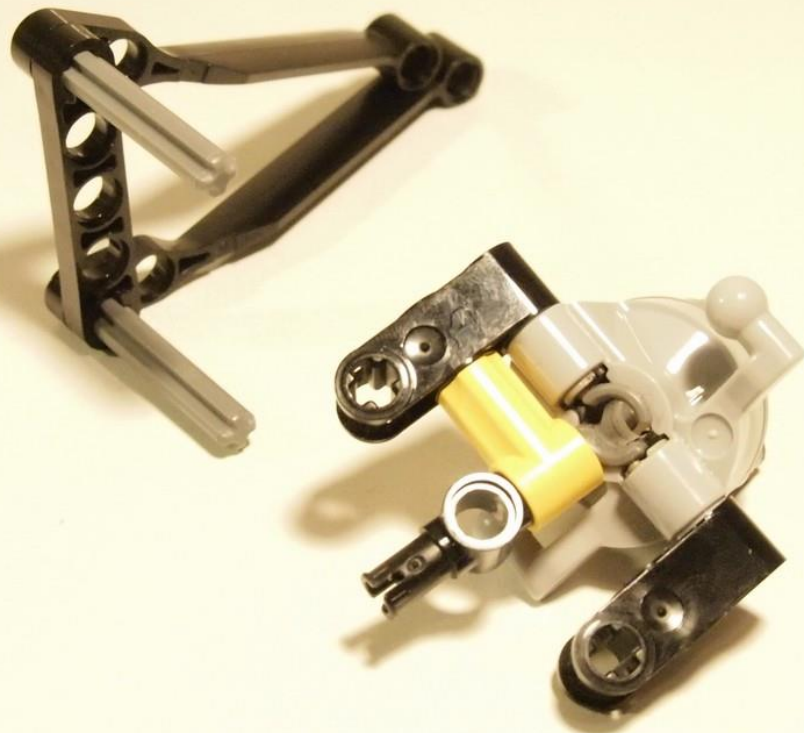

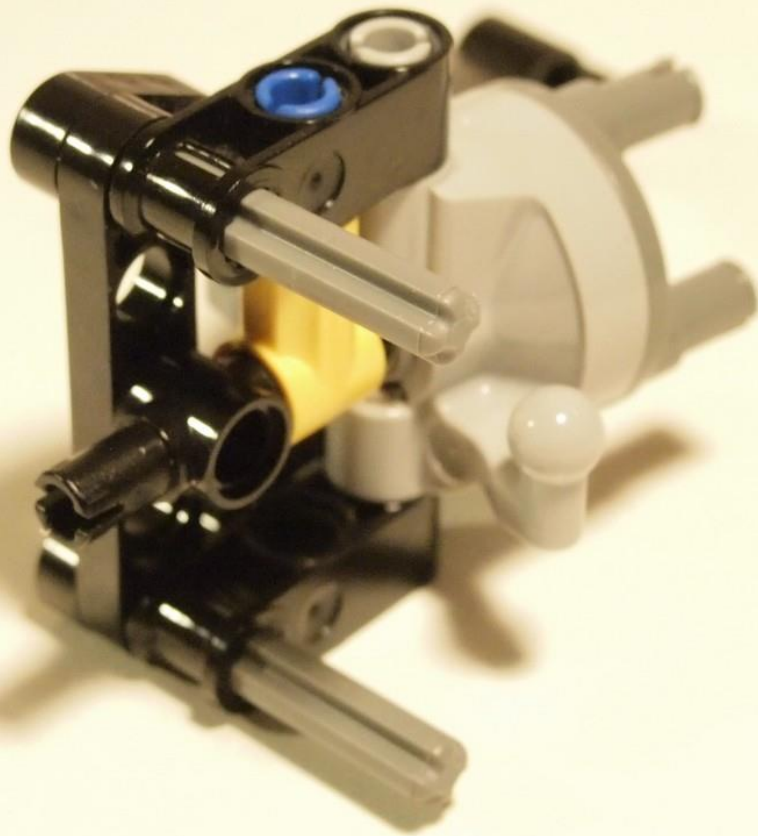



1x



1x

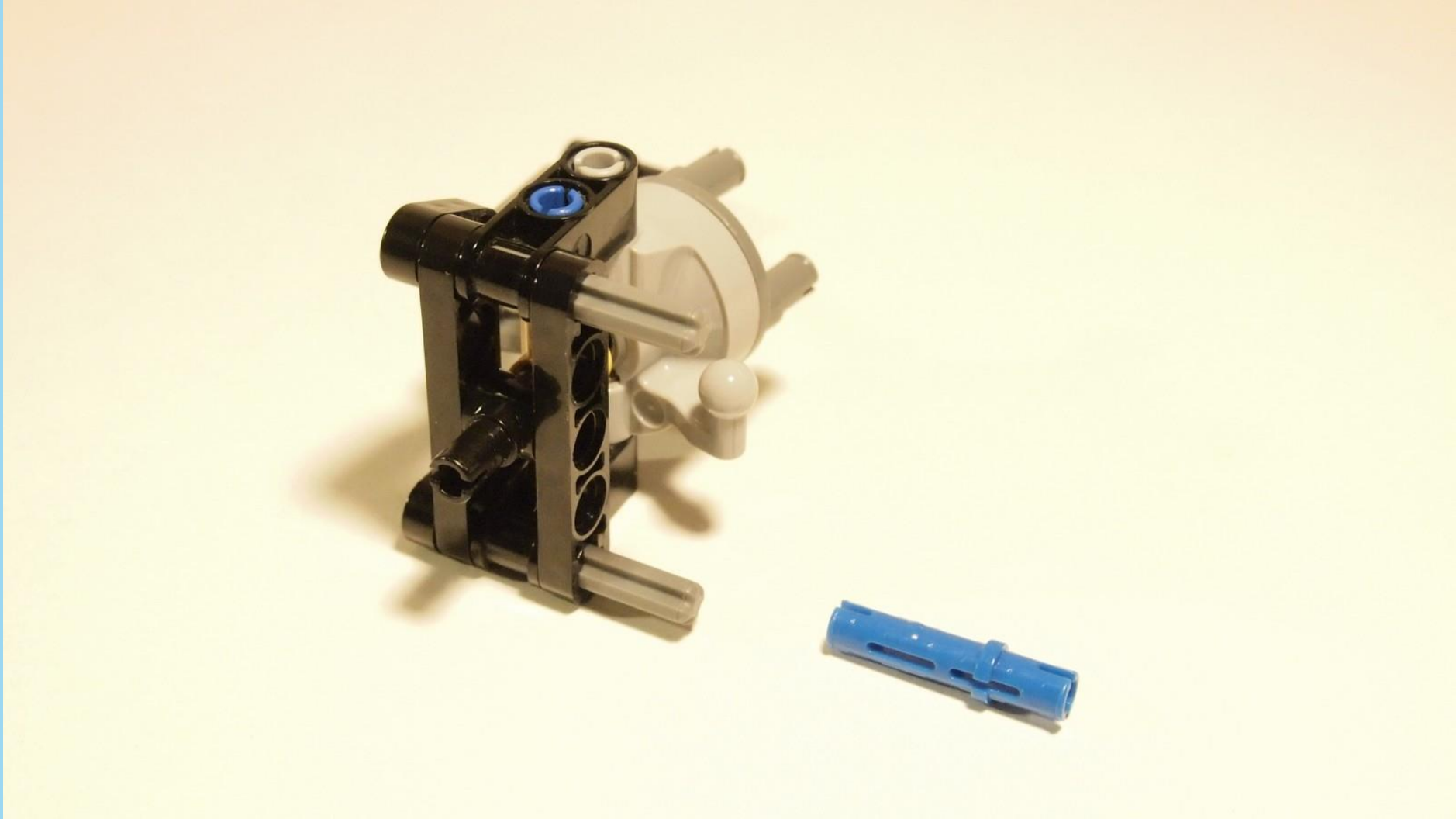



2x



1x



1x

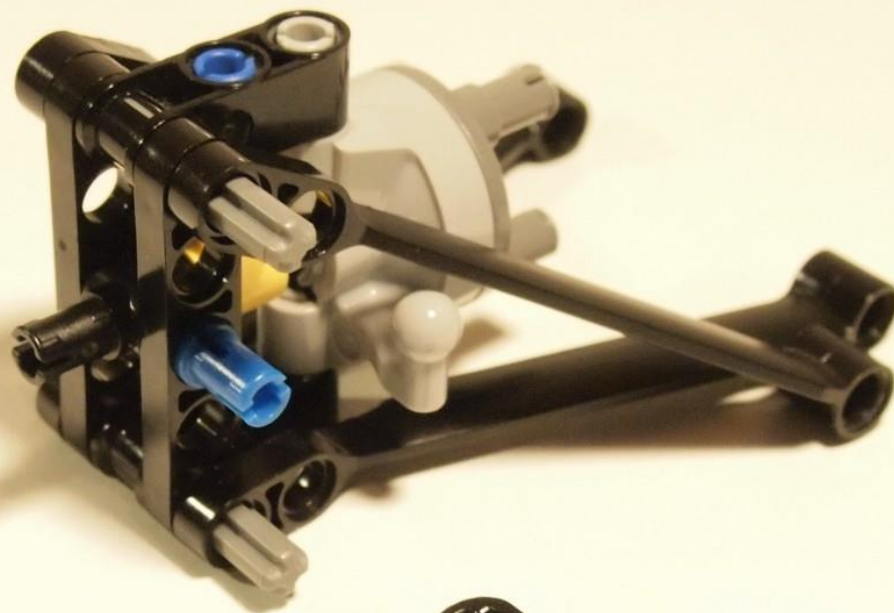



1x

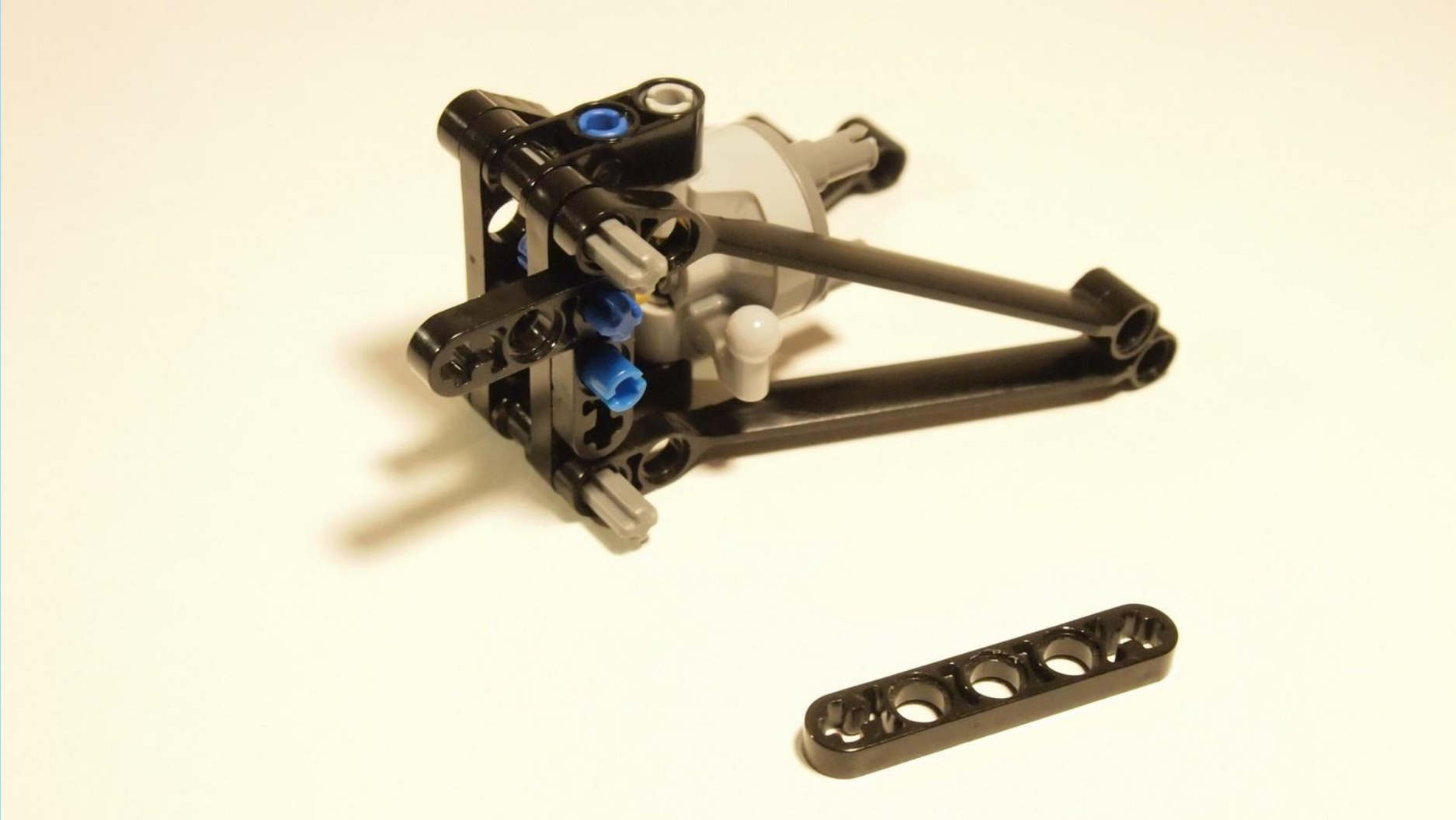

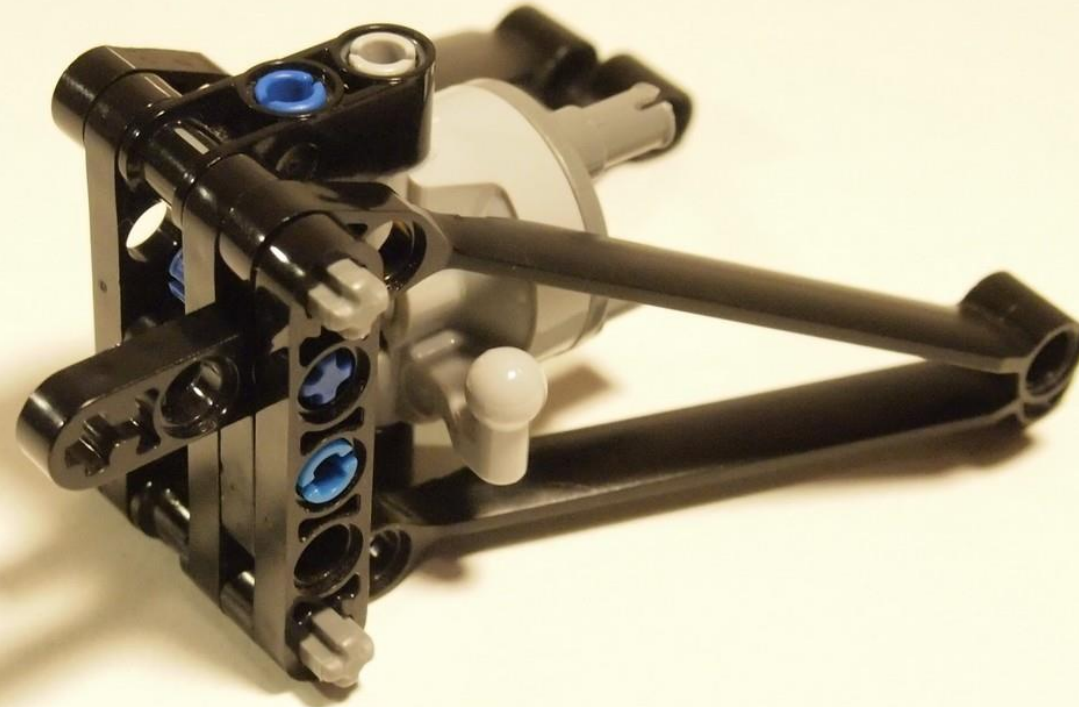



3x





1x



1x



1x

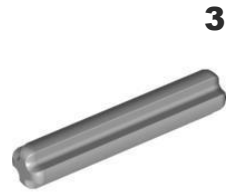

1x

3





1x



1x

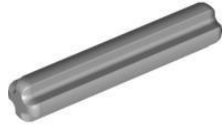

3

1x

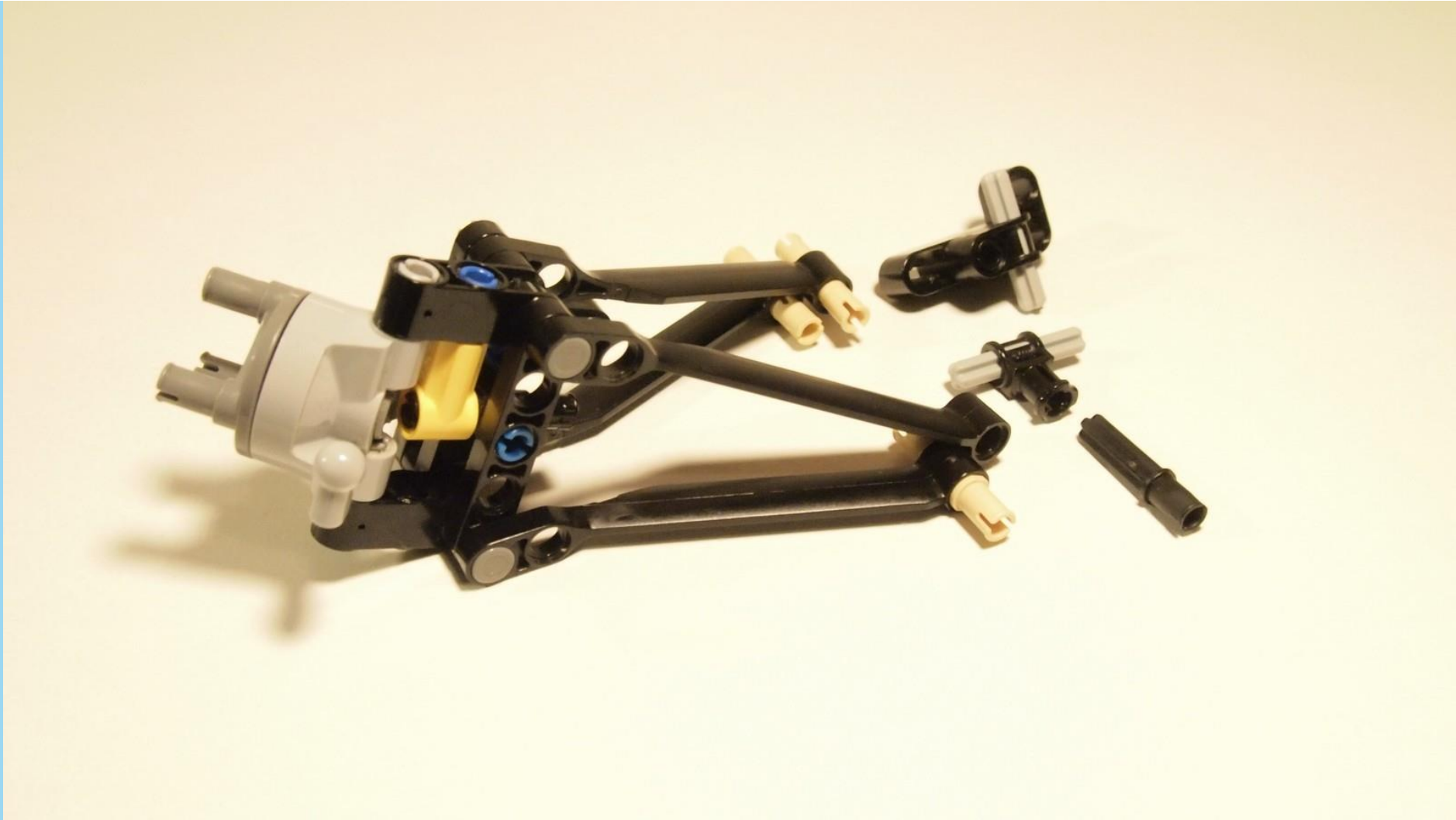

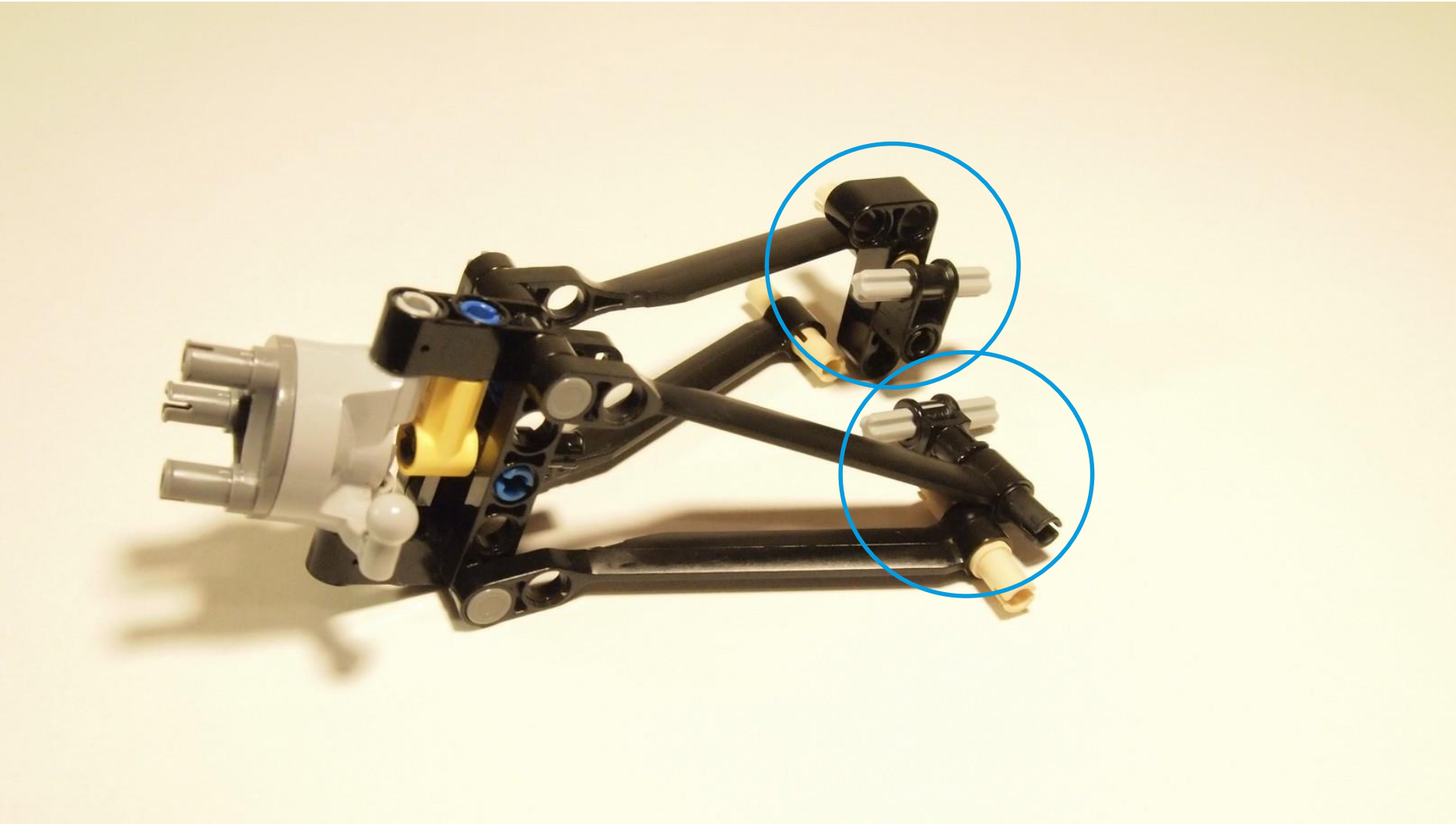



1x



2x



2x

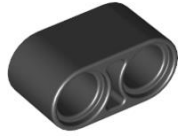

1x



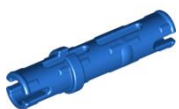

2x



2x



4x

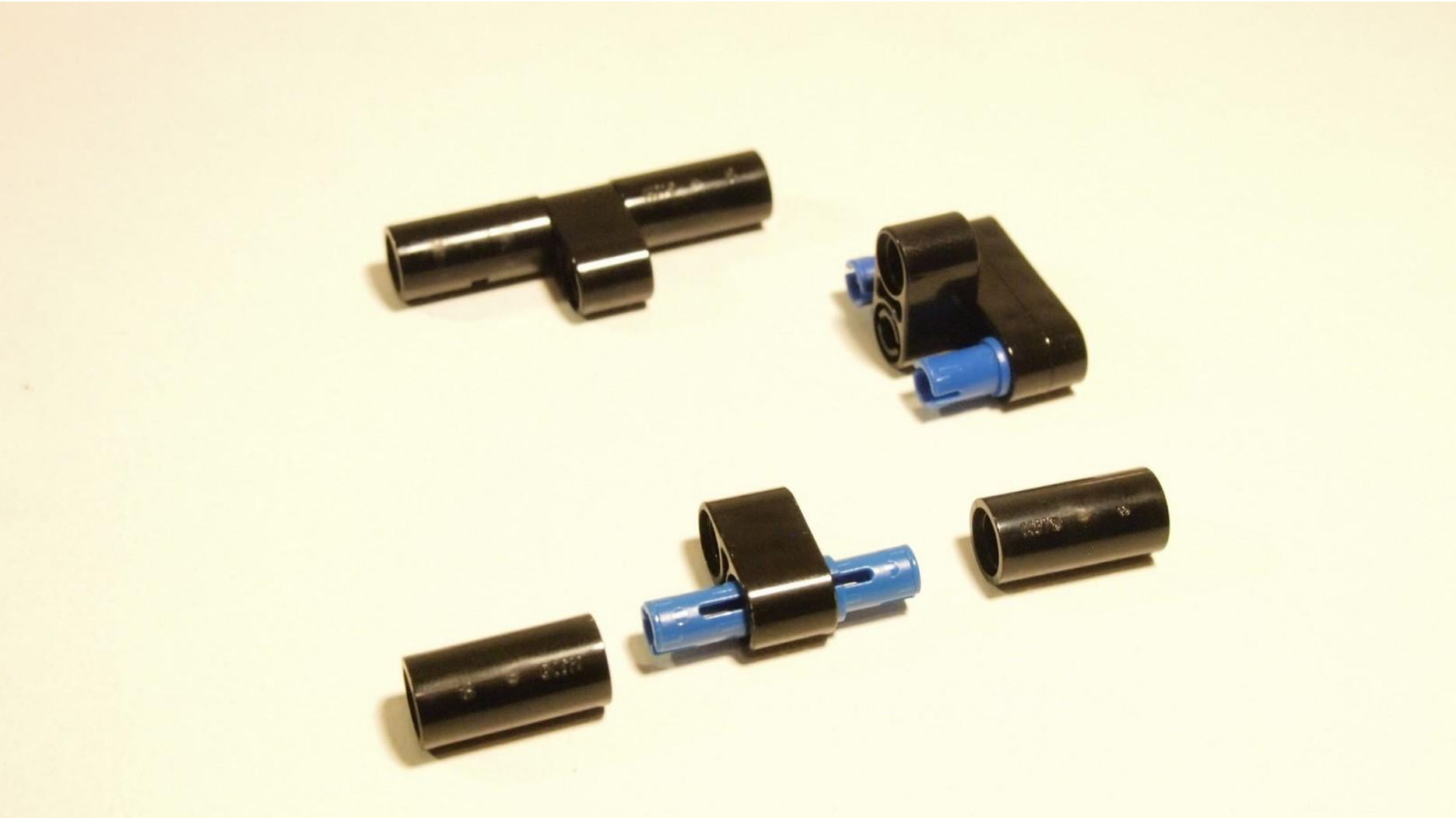

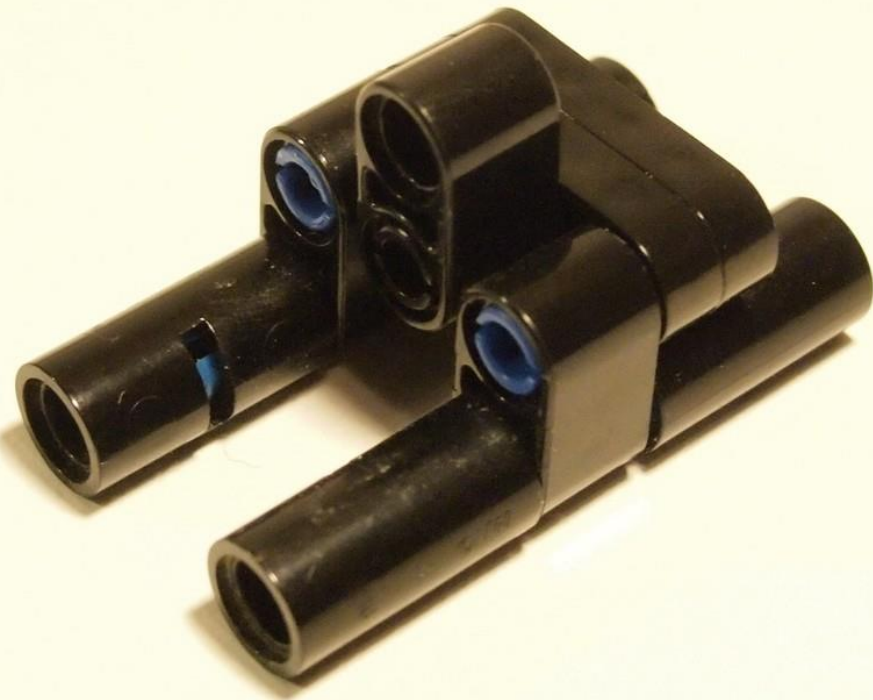



1x



3x



2x



1x



1x

4

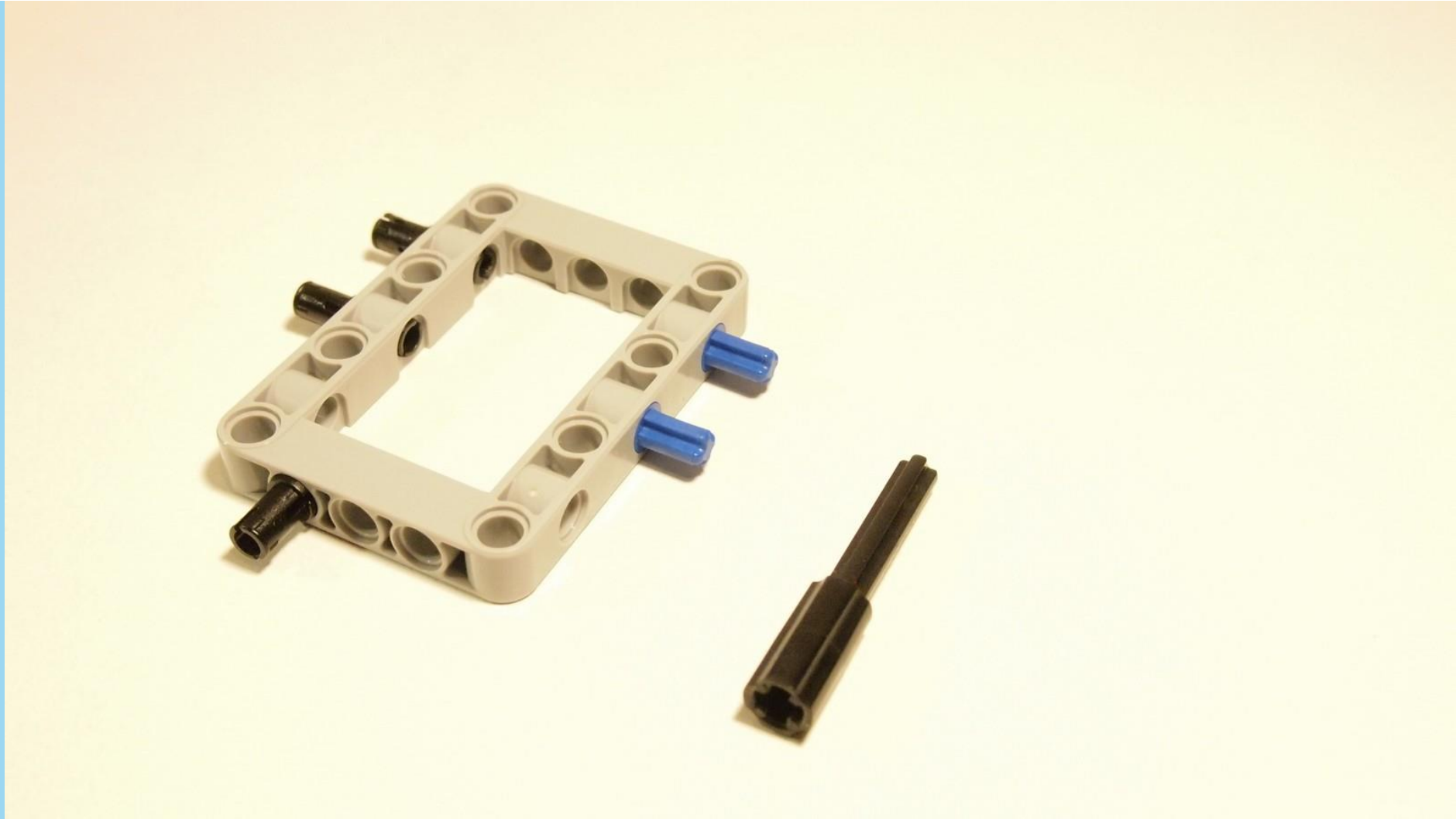

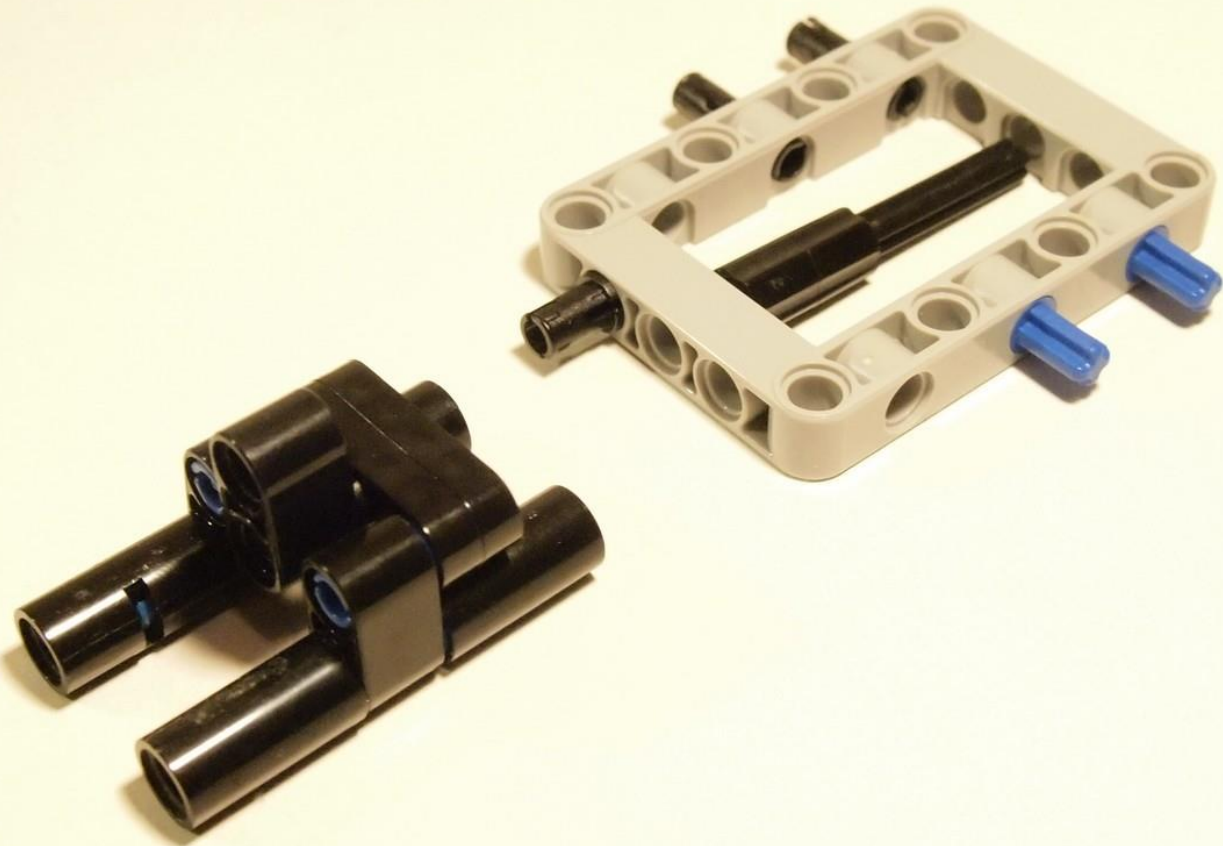

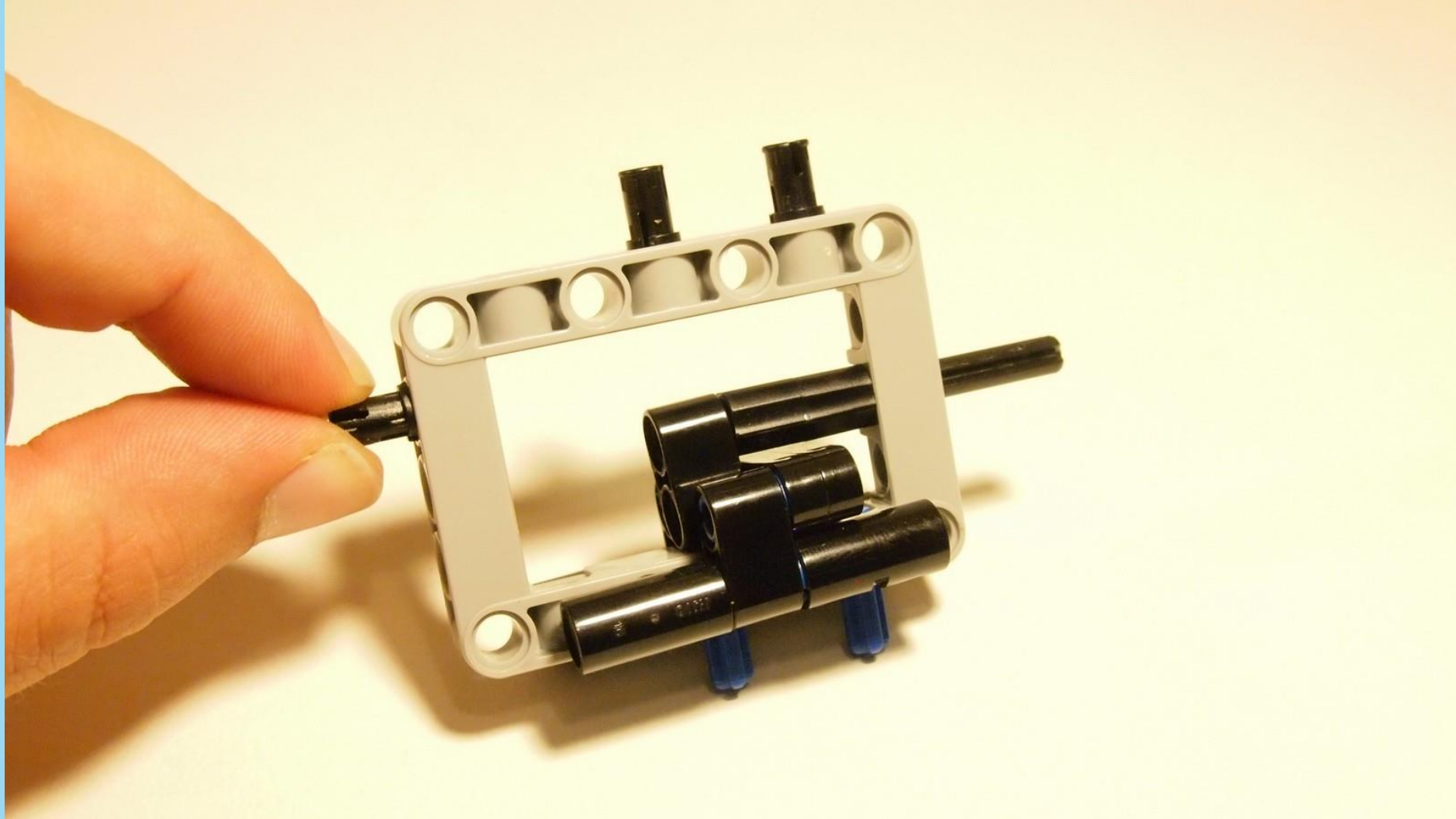



1x



2x



2x



2x

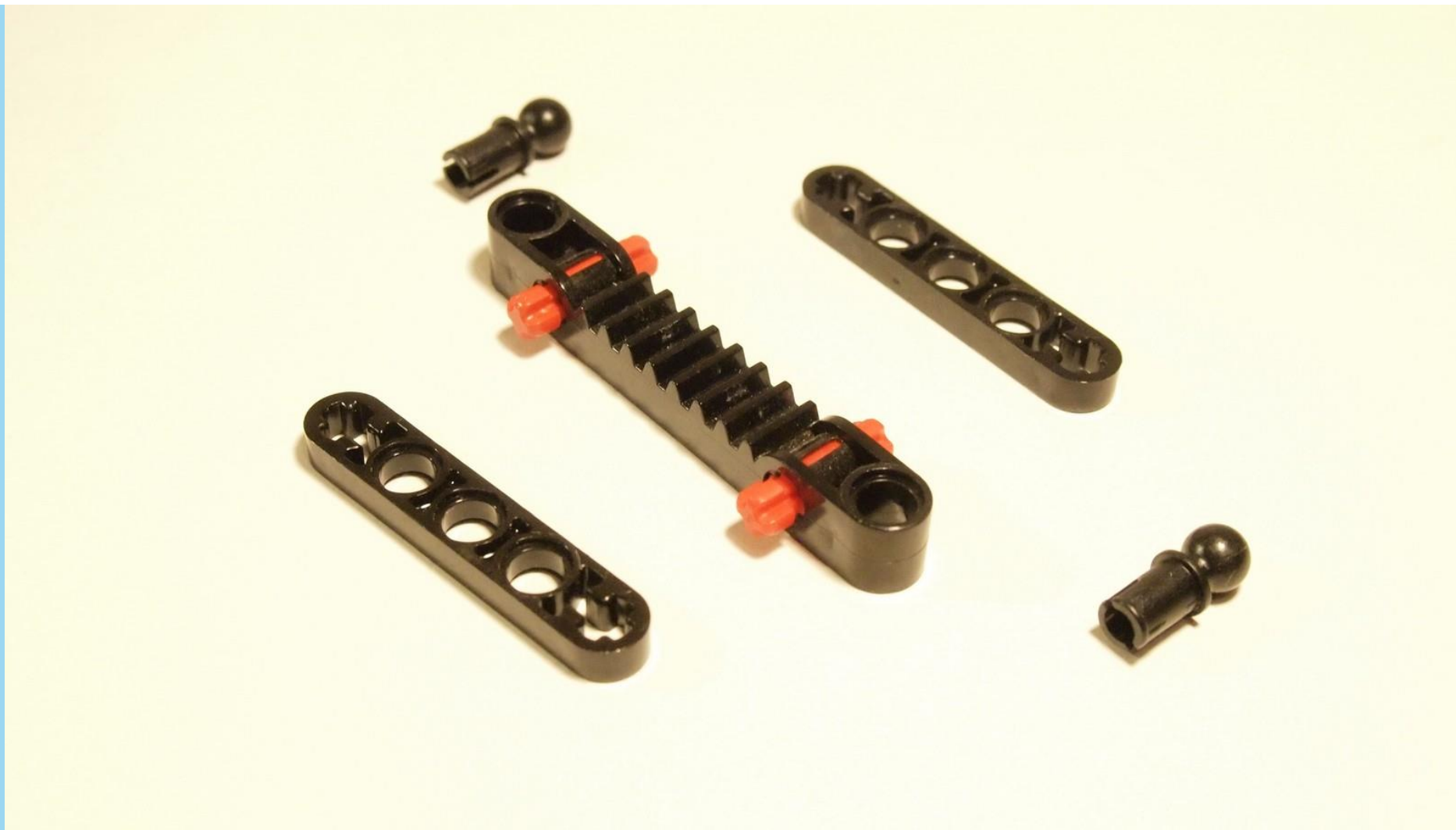

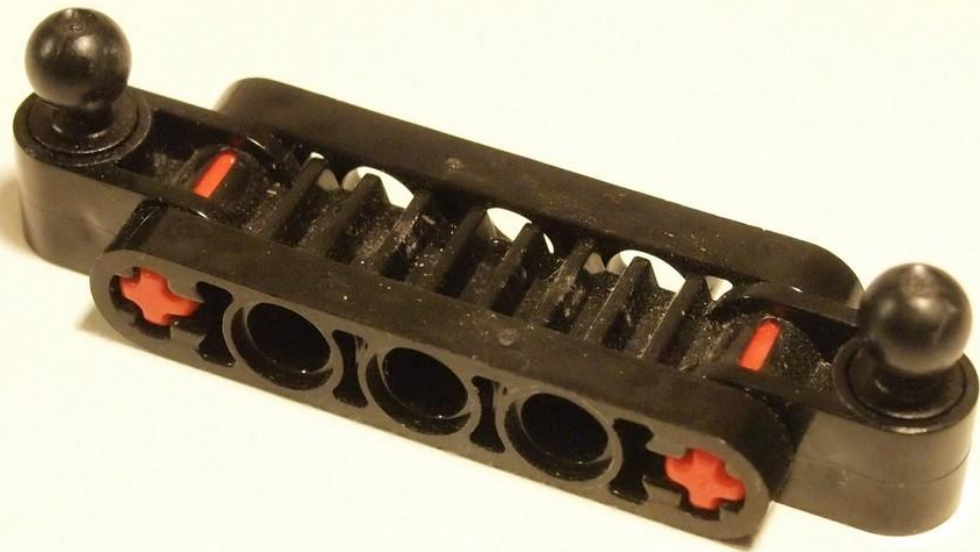

6



1x



1x

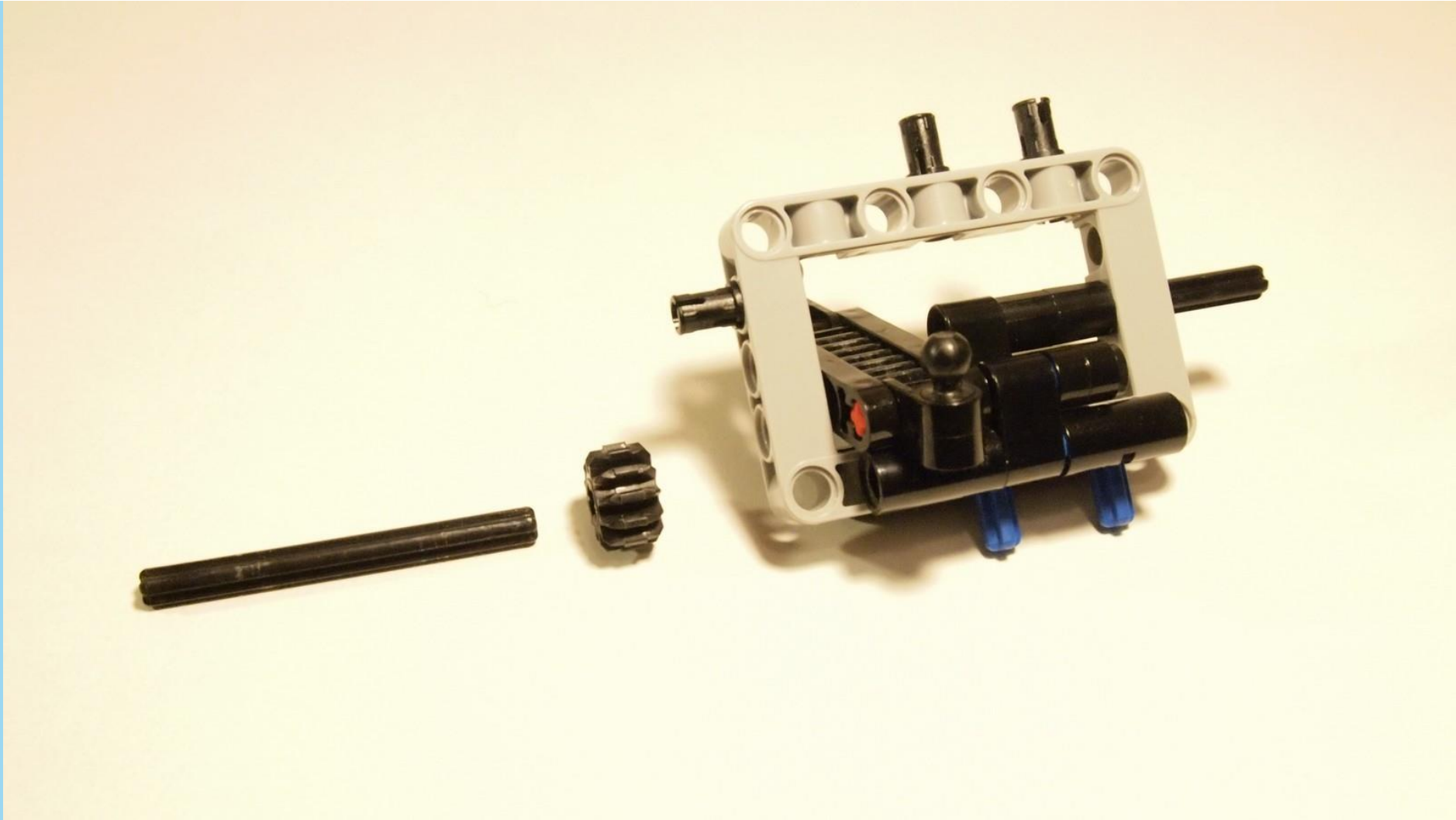

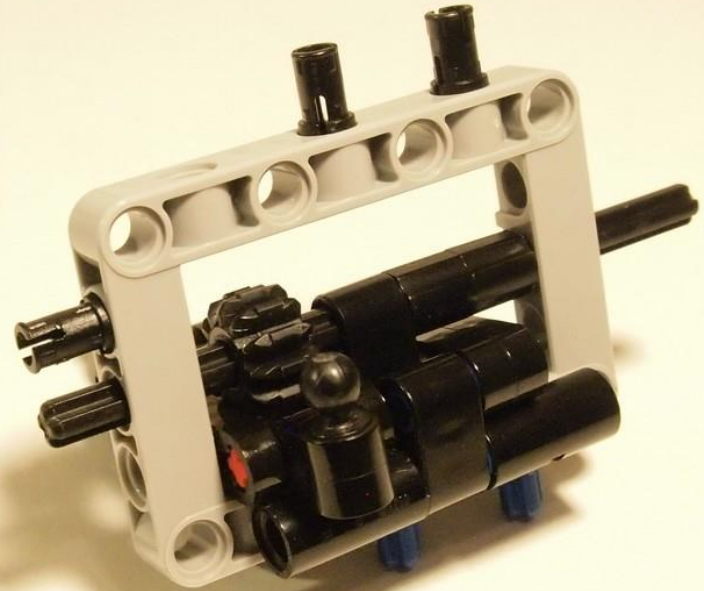



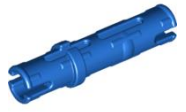

1x



1x



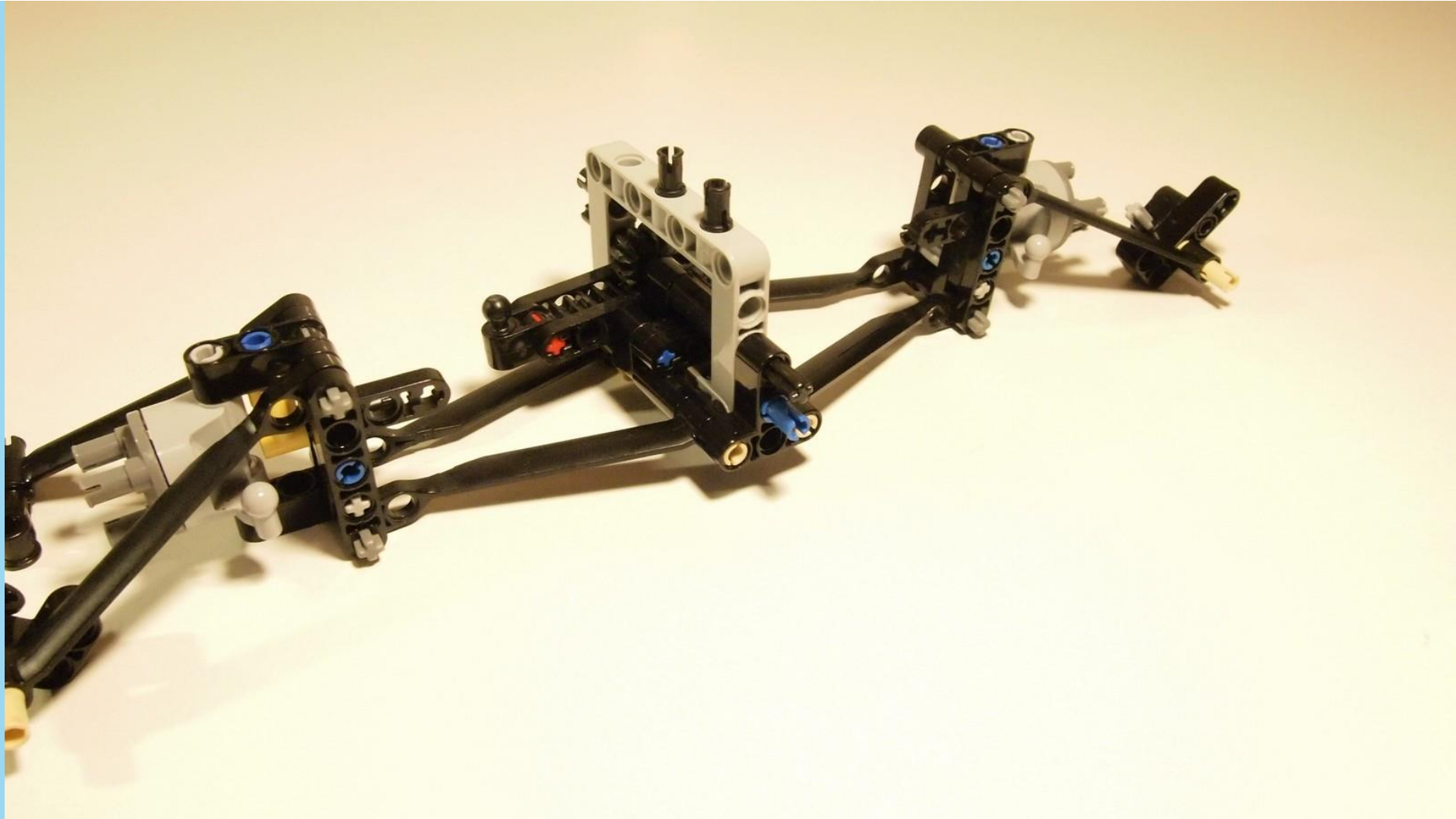

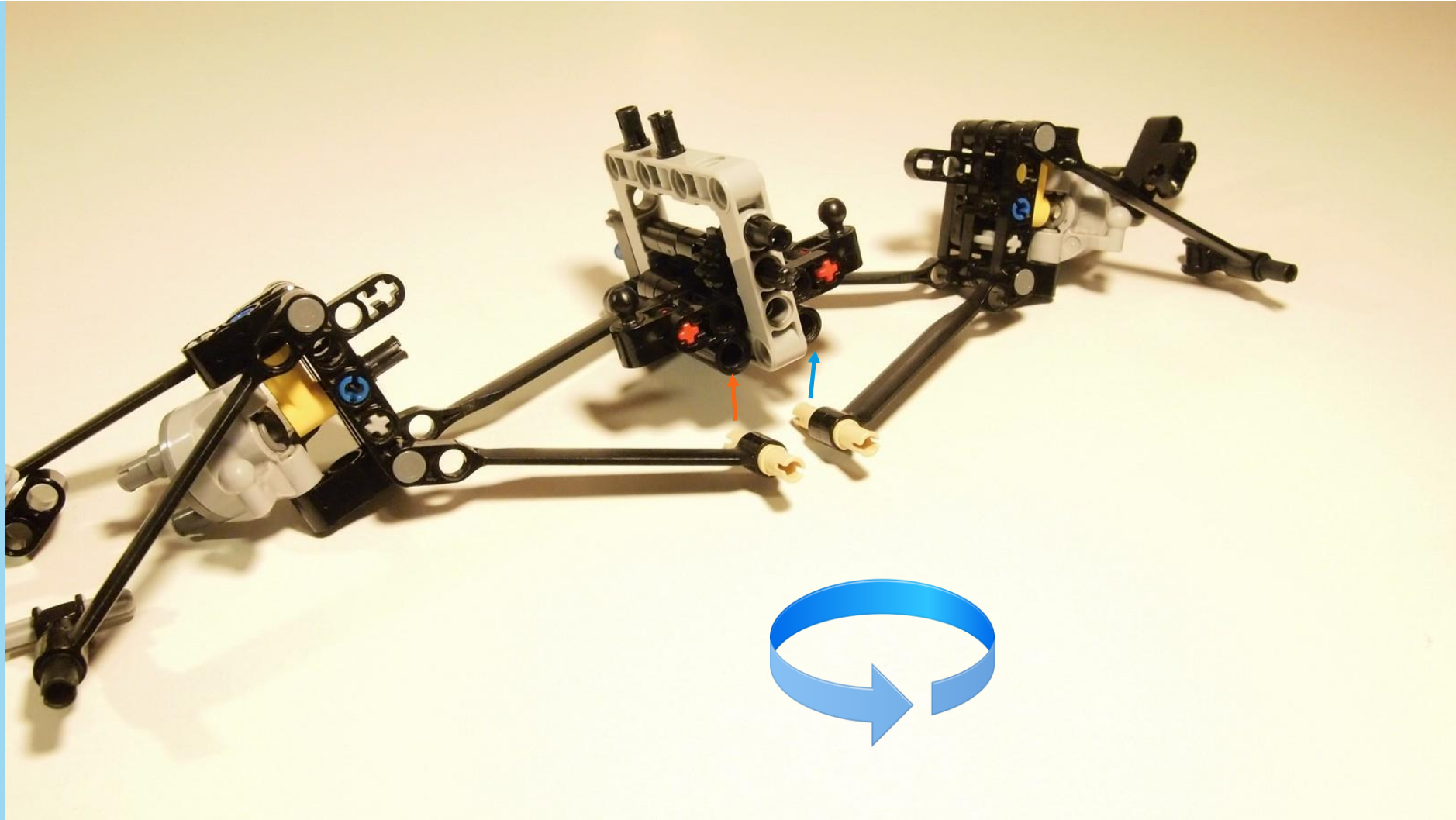



2x



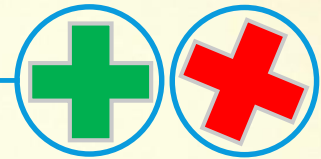
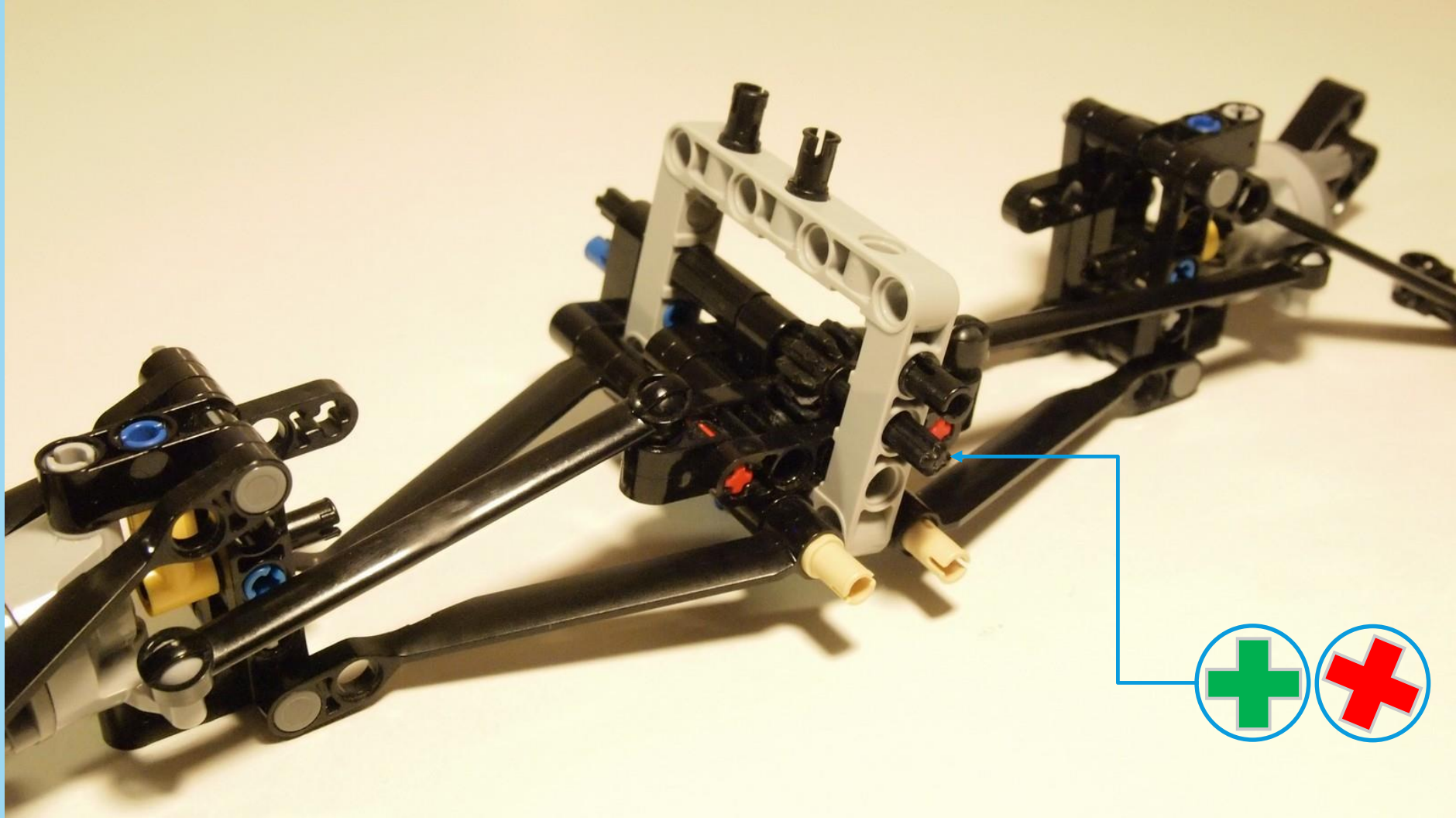



2x



2x



2x



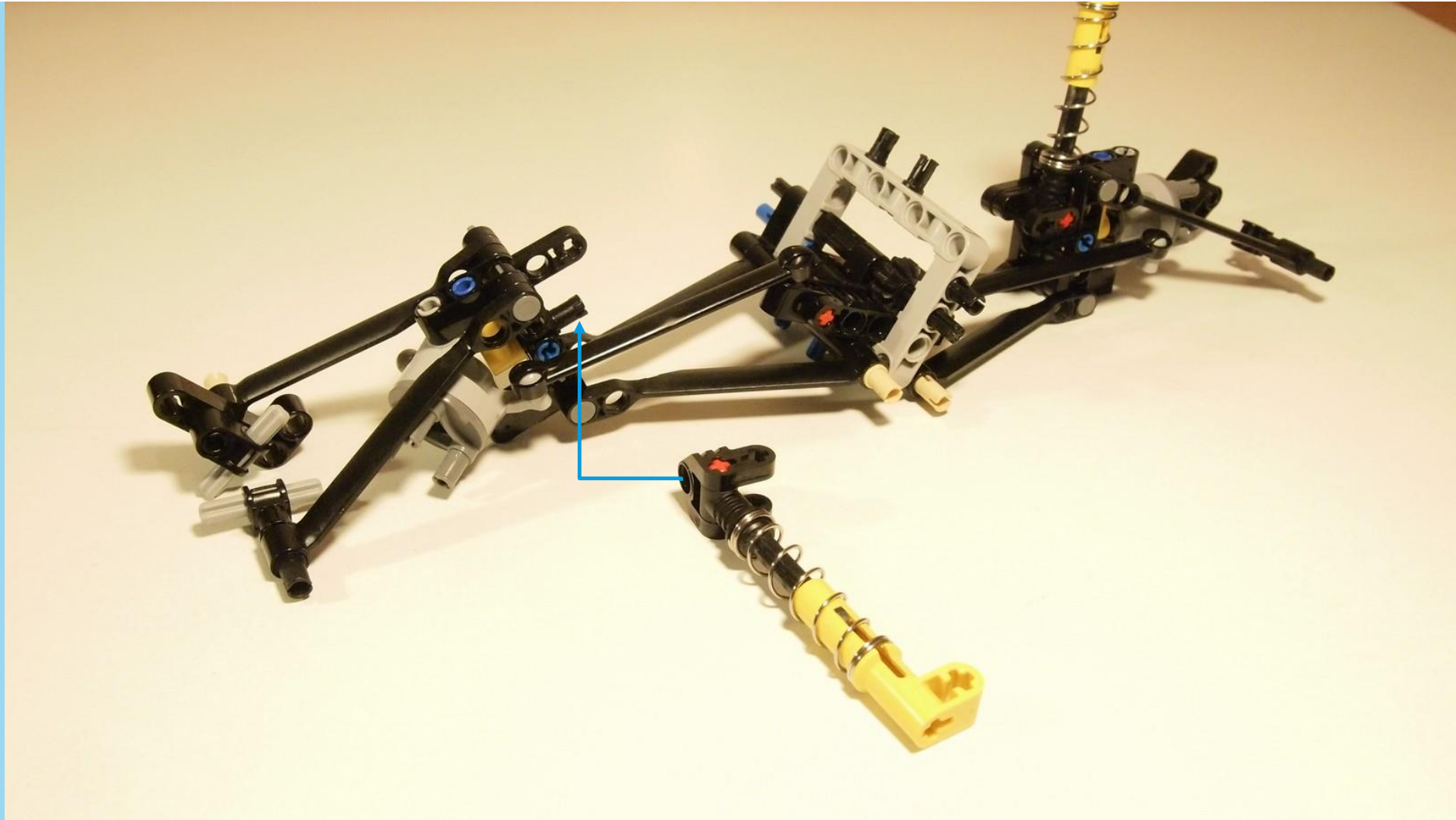

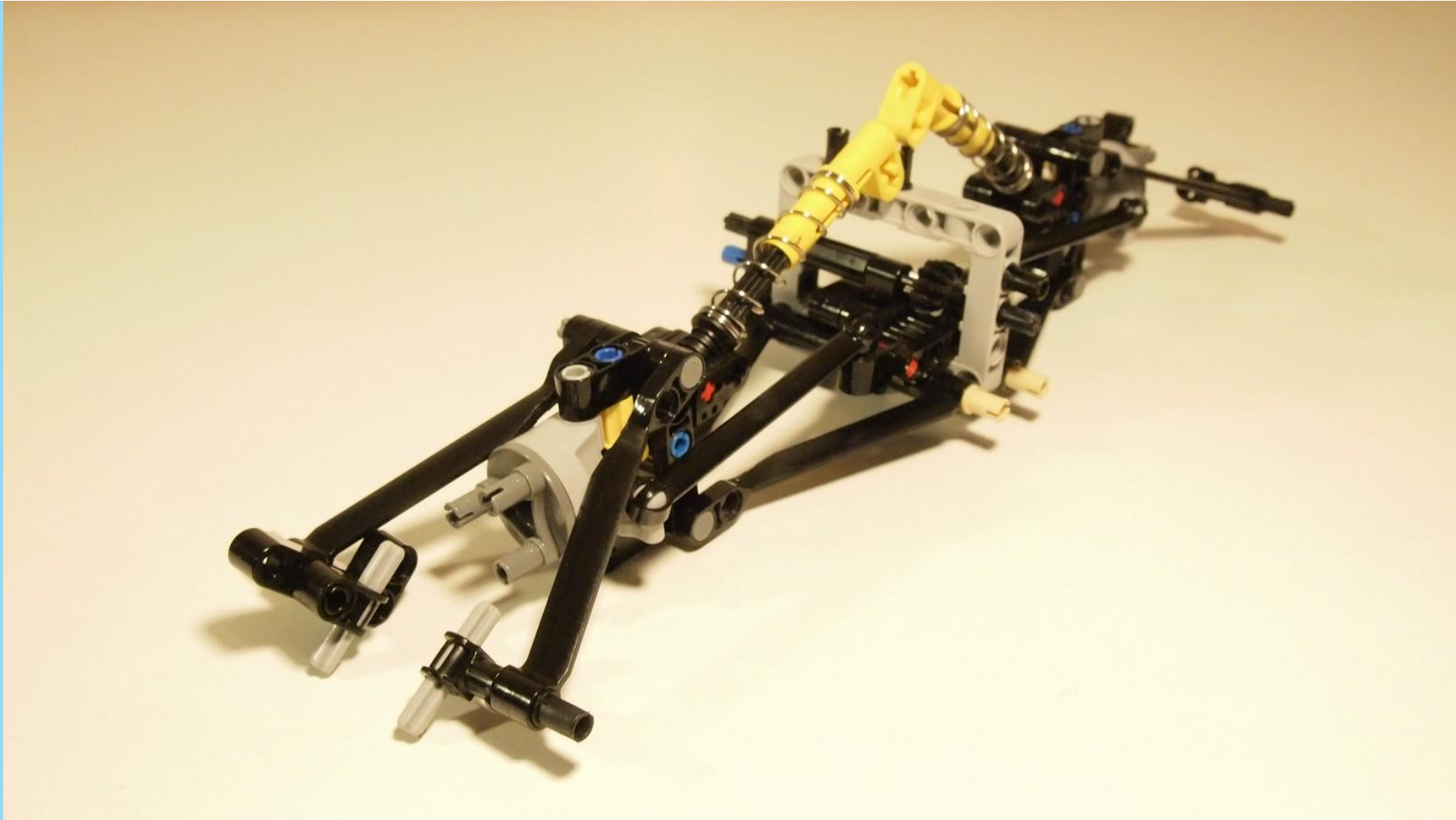

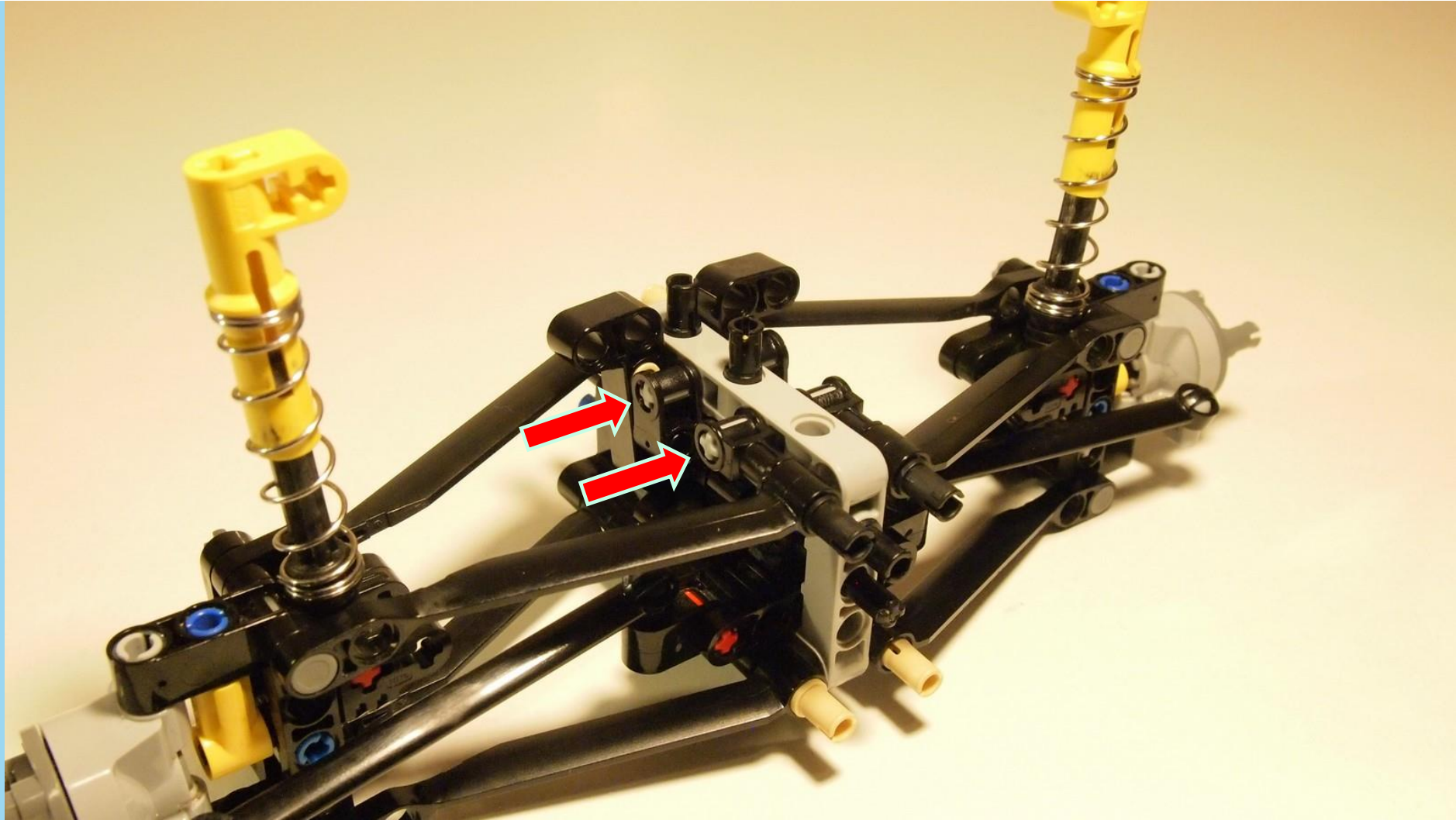

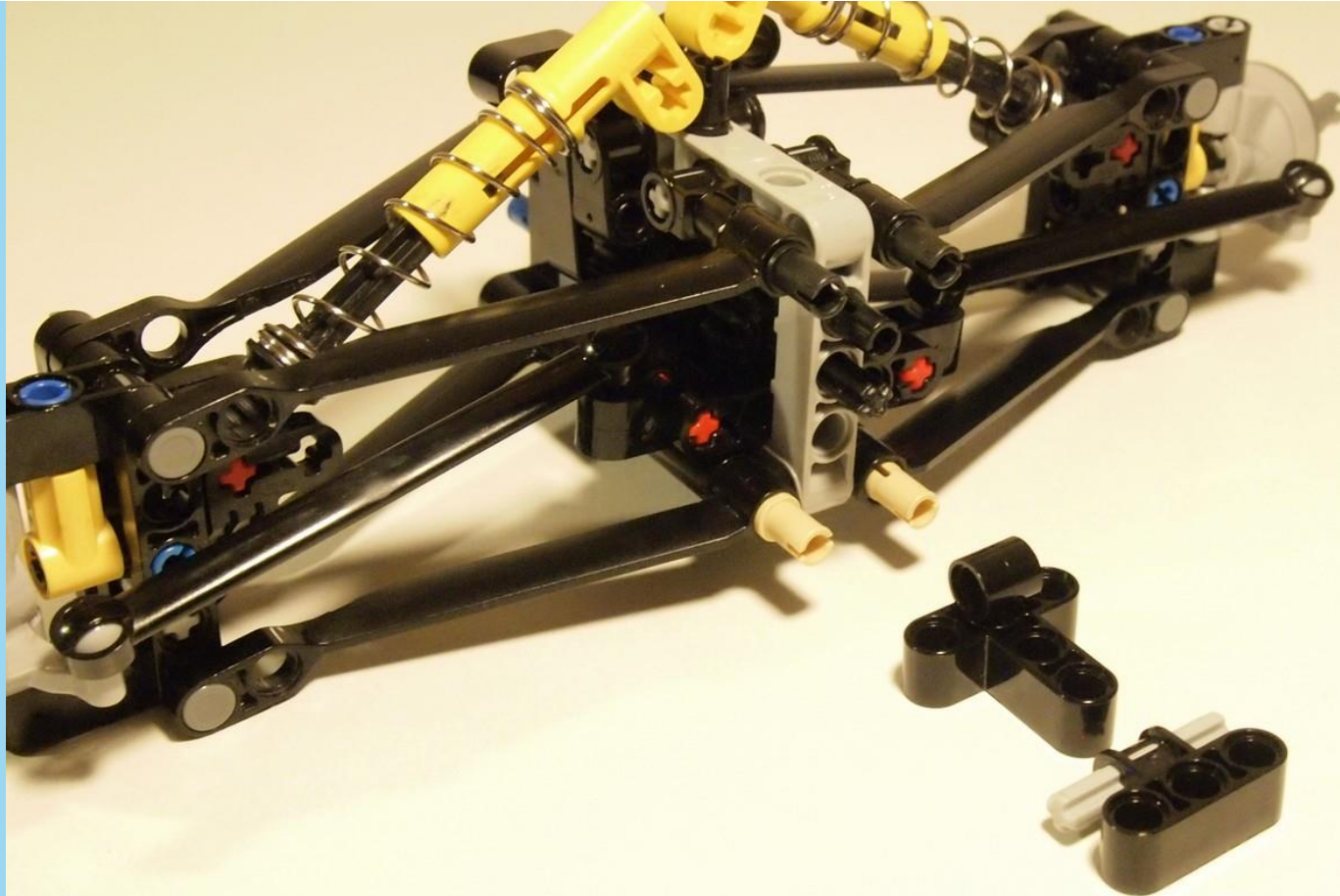
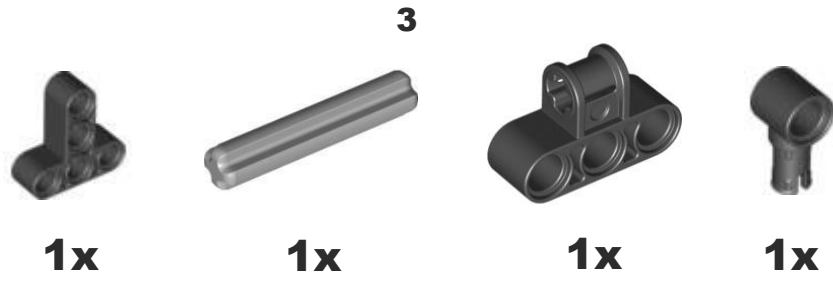

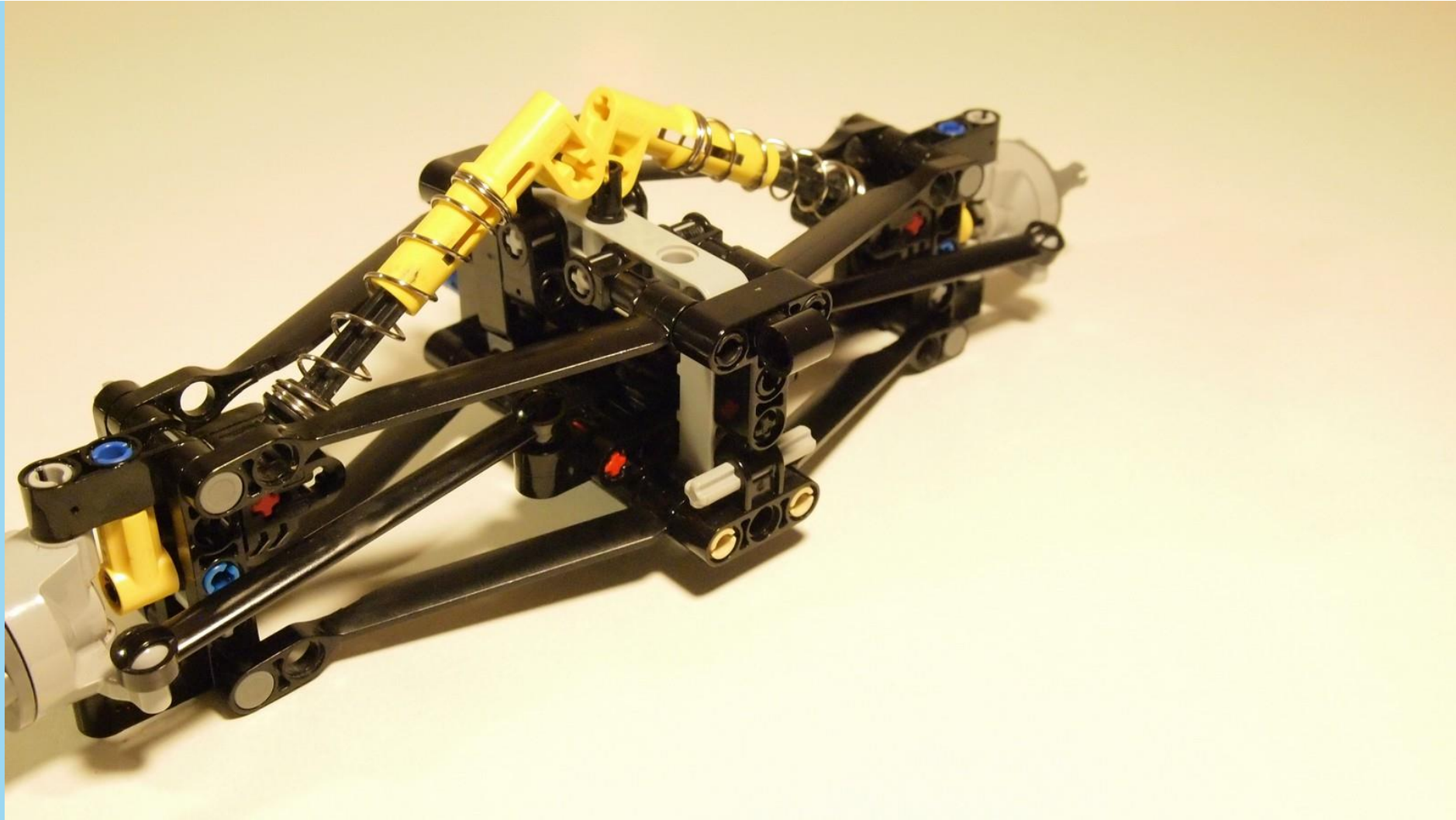

3



1x



1x



1x



2x



1x

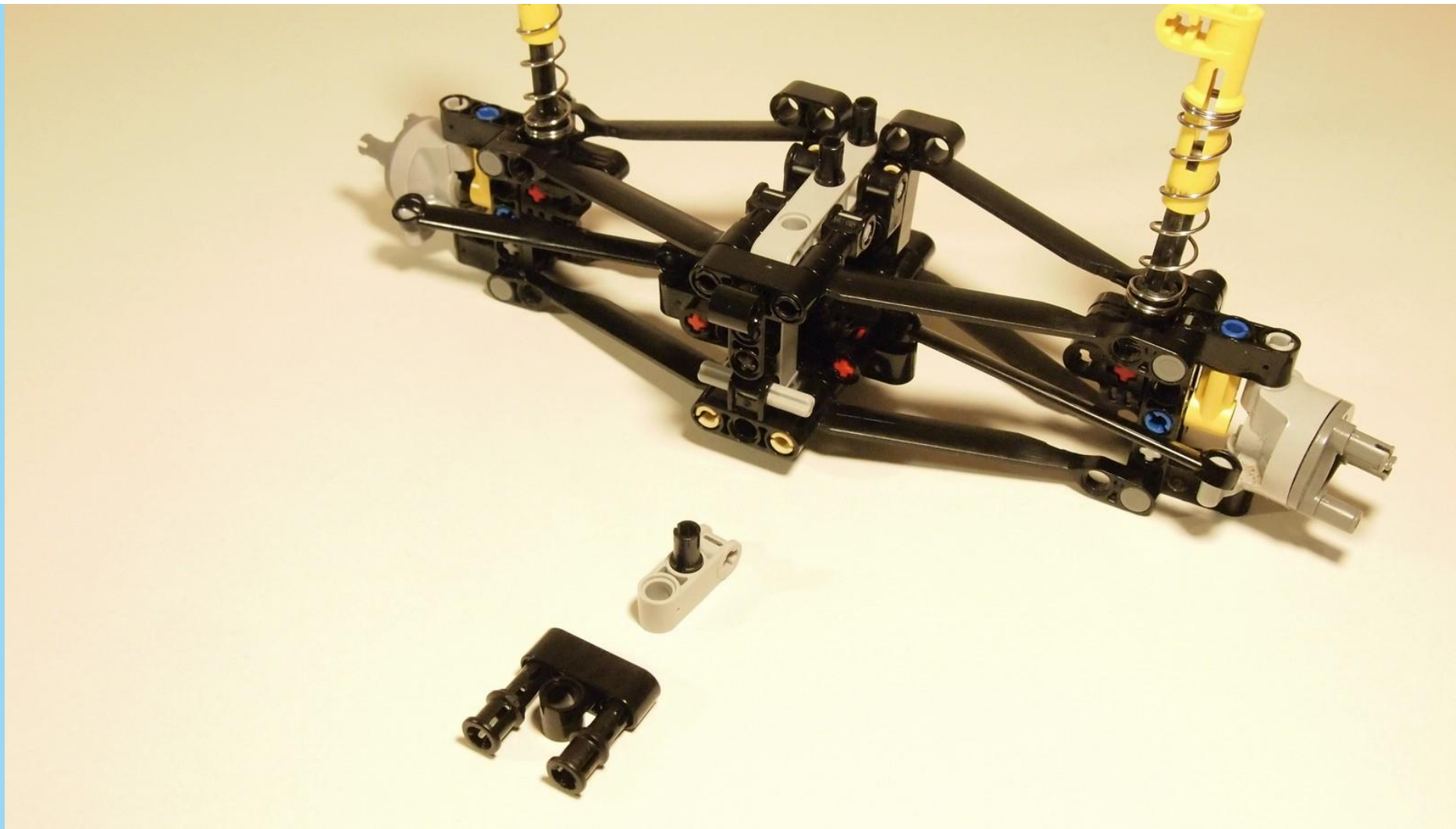

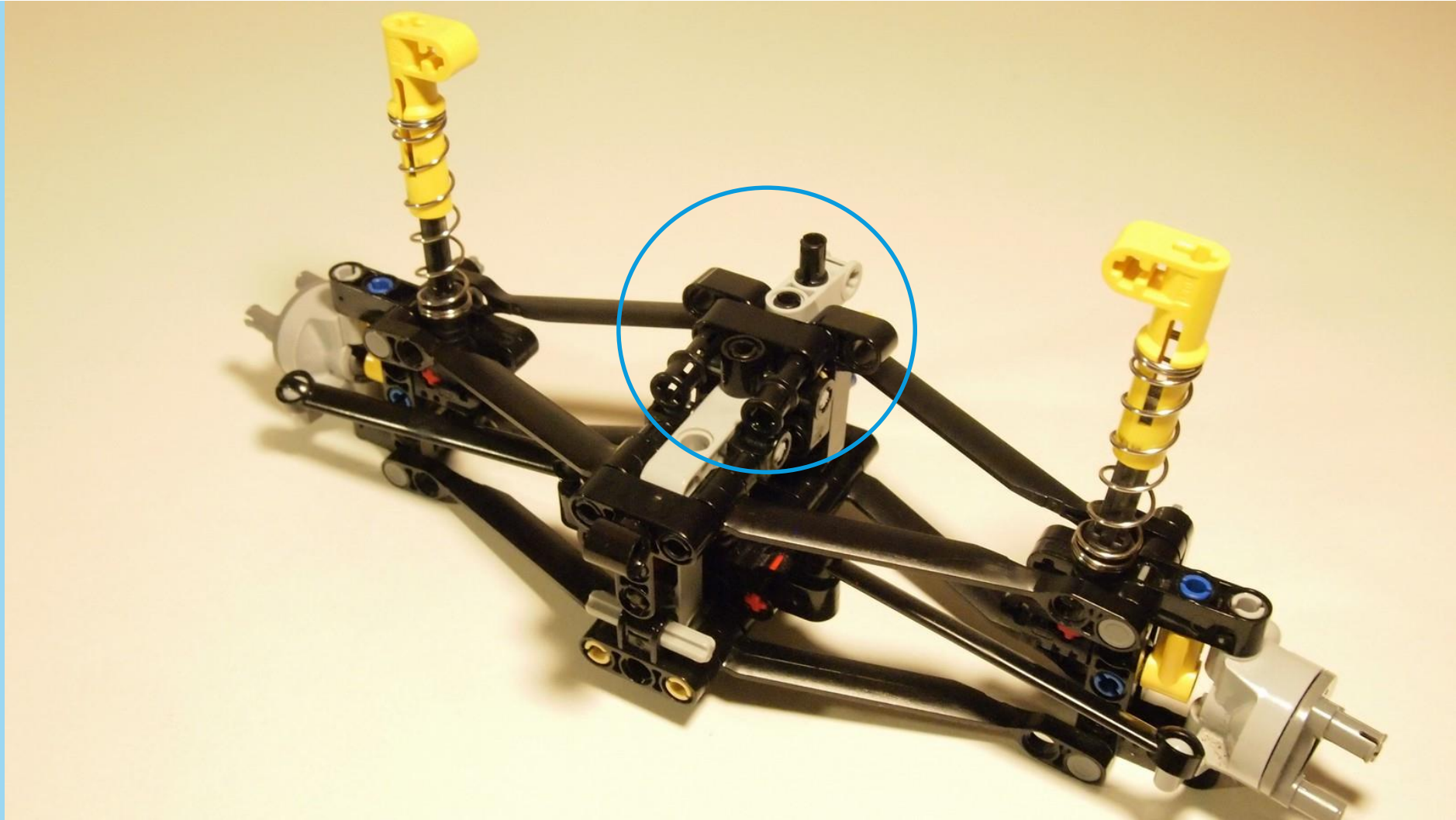

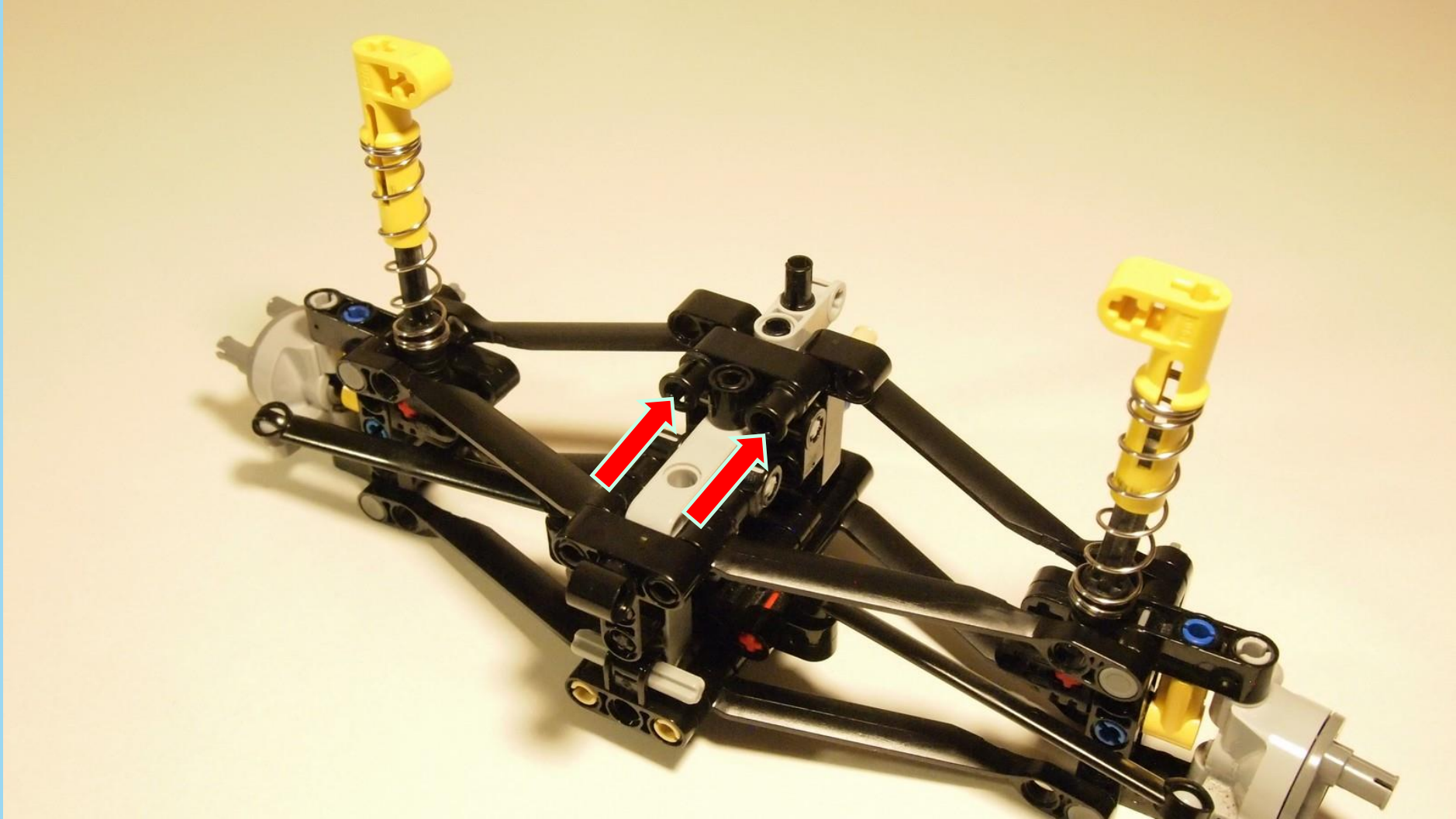



1x



2x



2x



2x

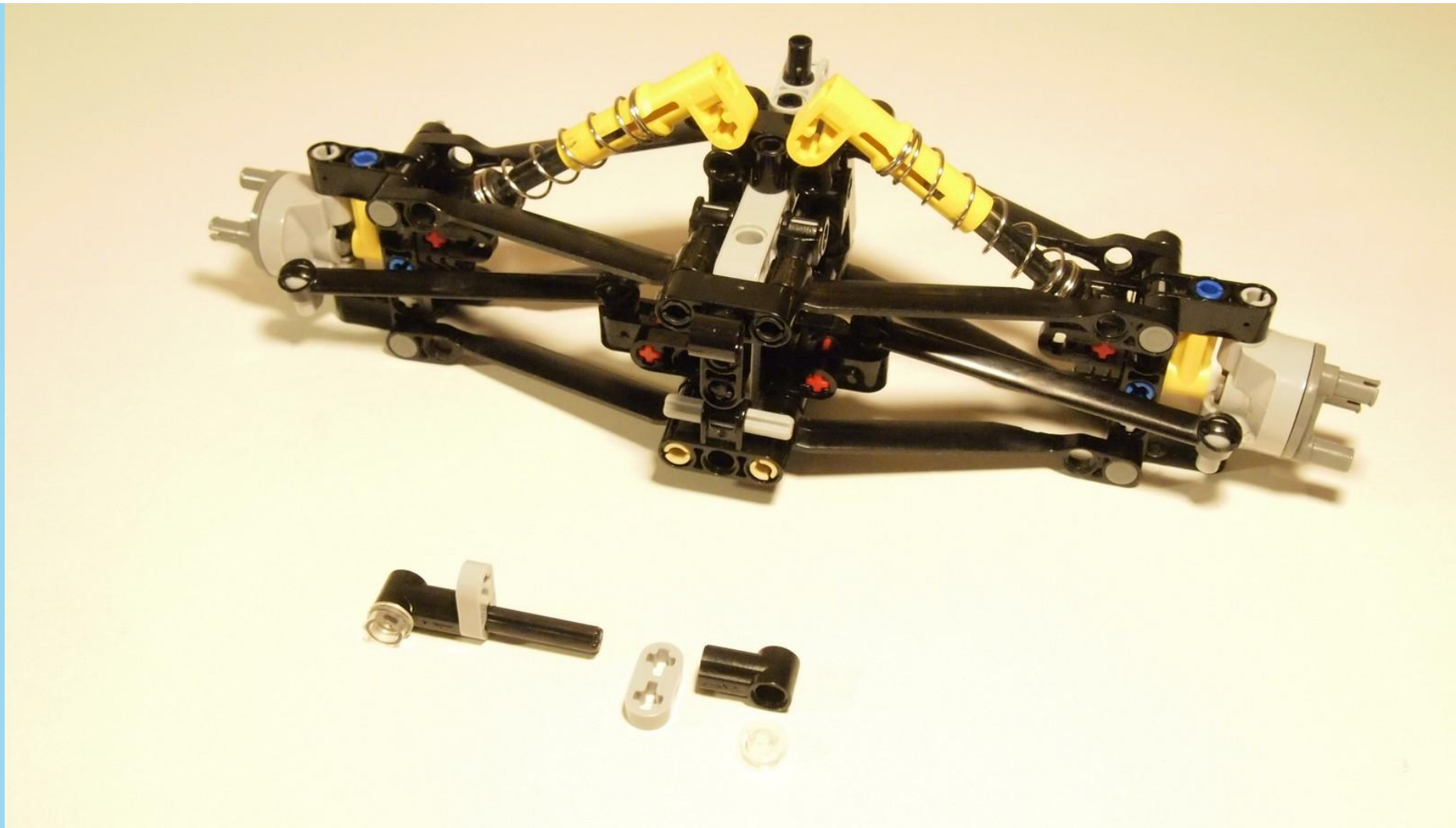

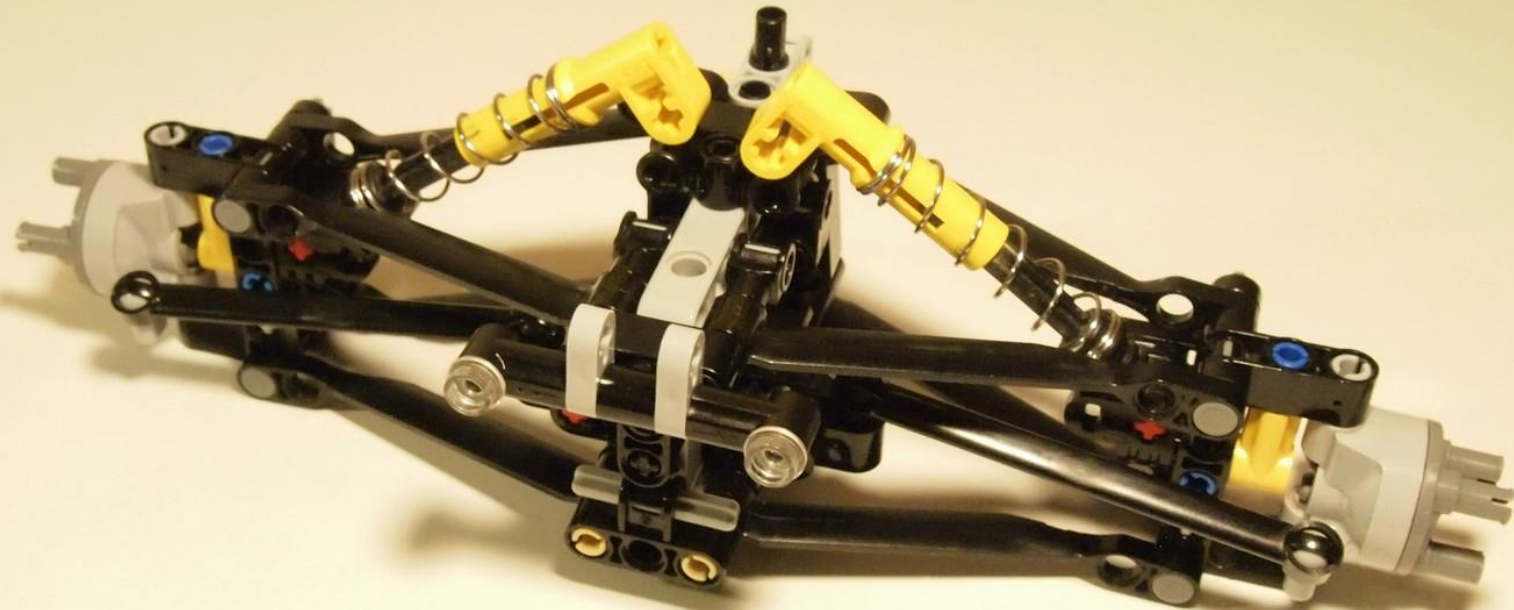



2x



2x



2x



2x

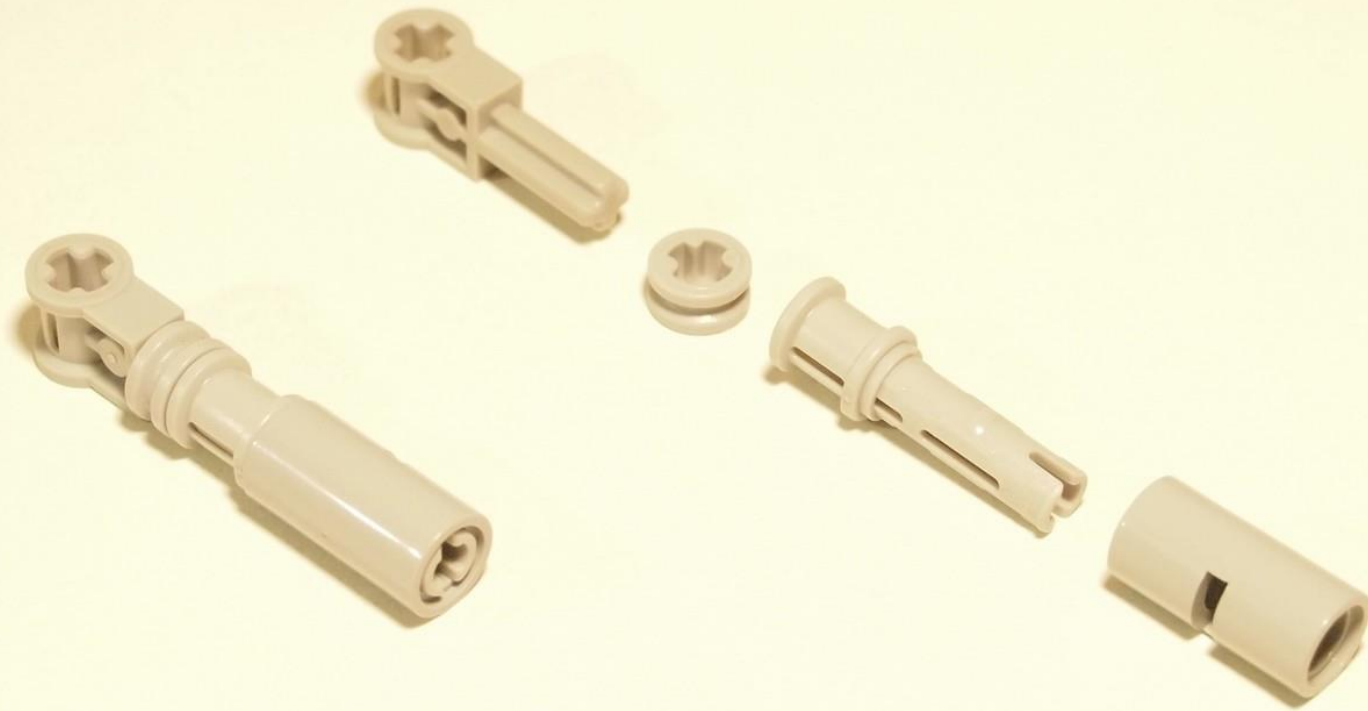



4

2x



2x

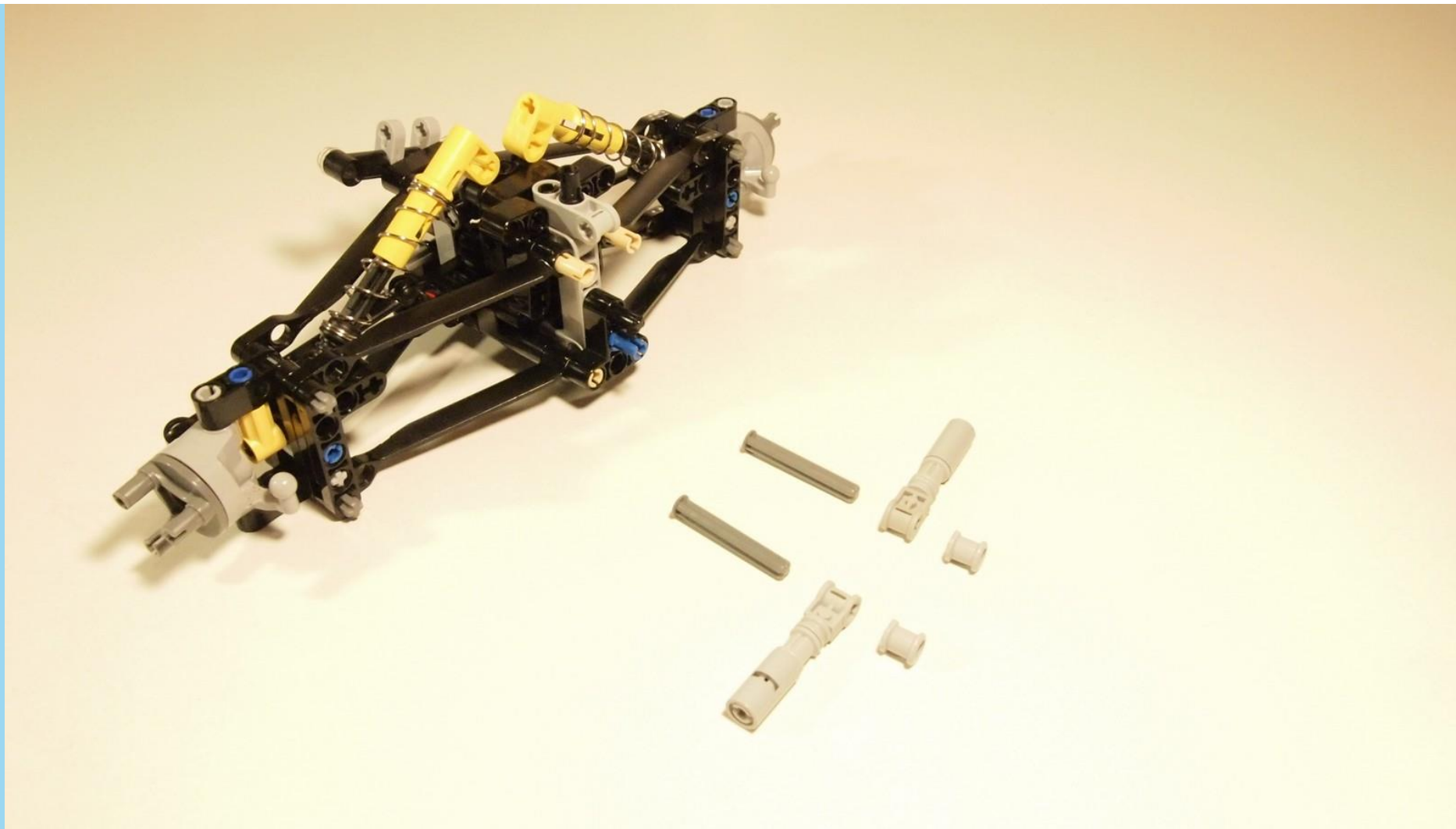

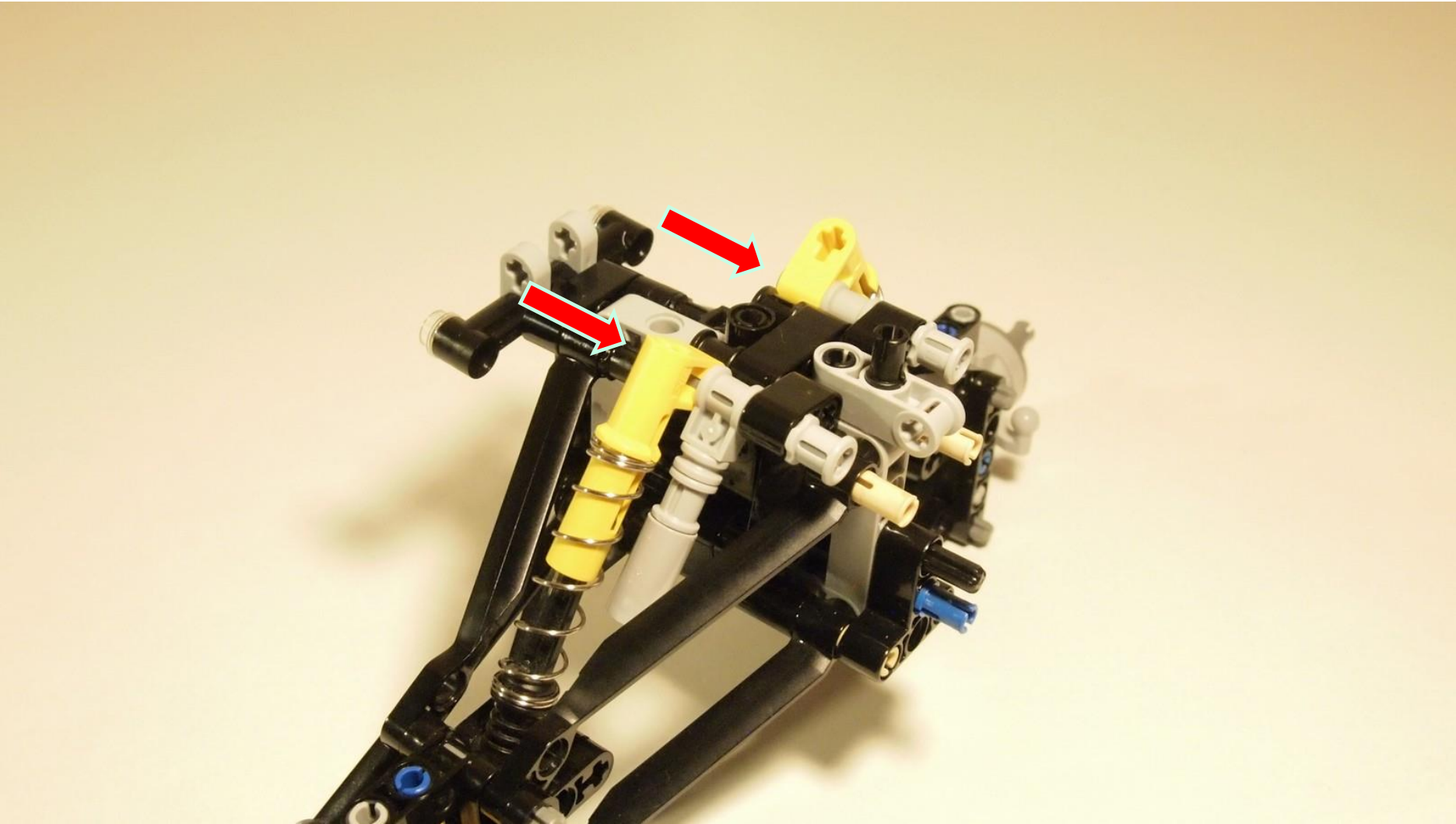



2x



2x

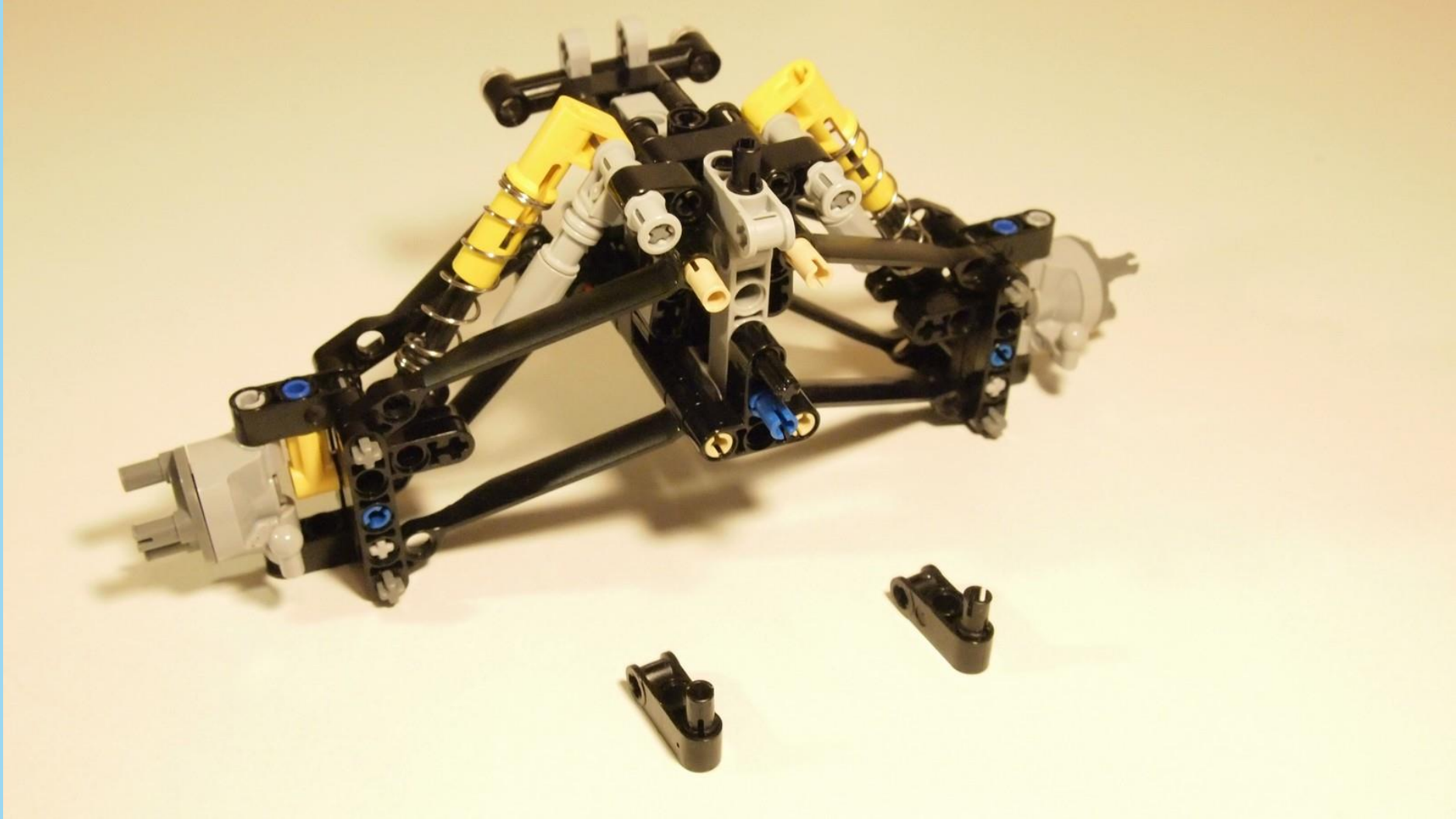

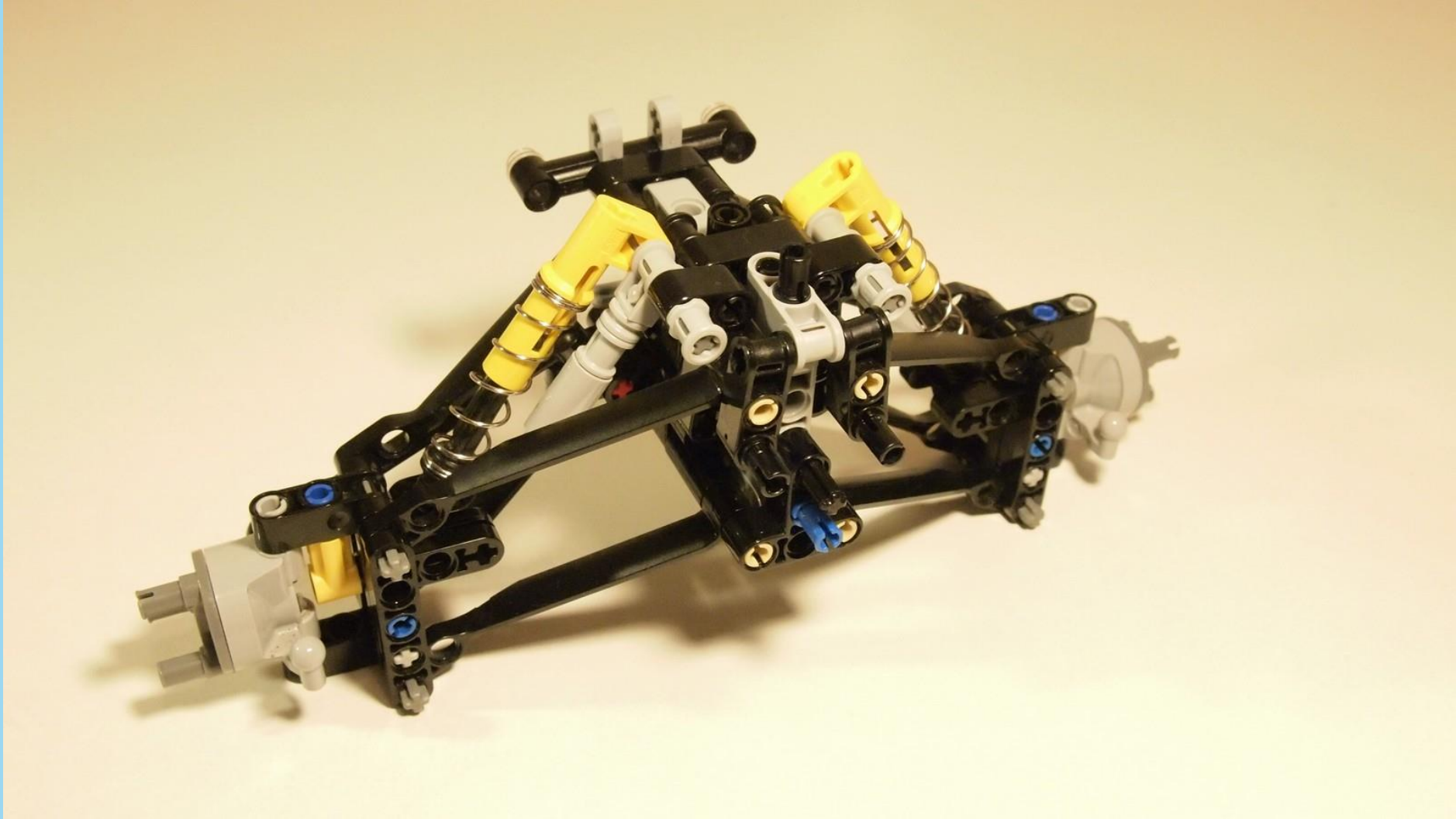



1x

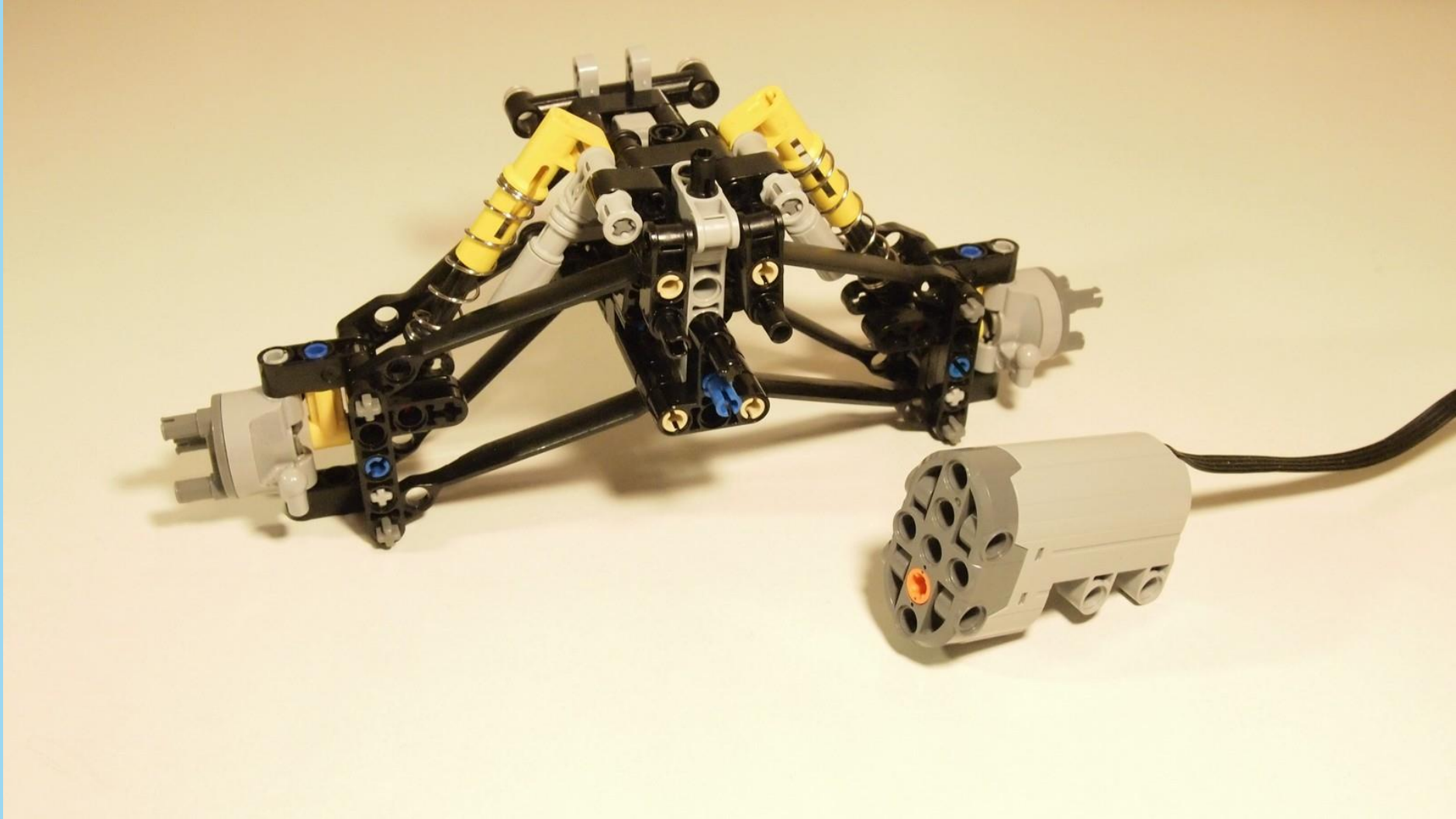



2x

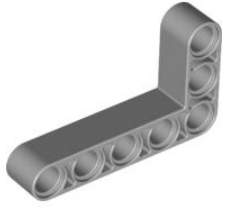

2x

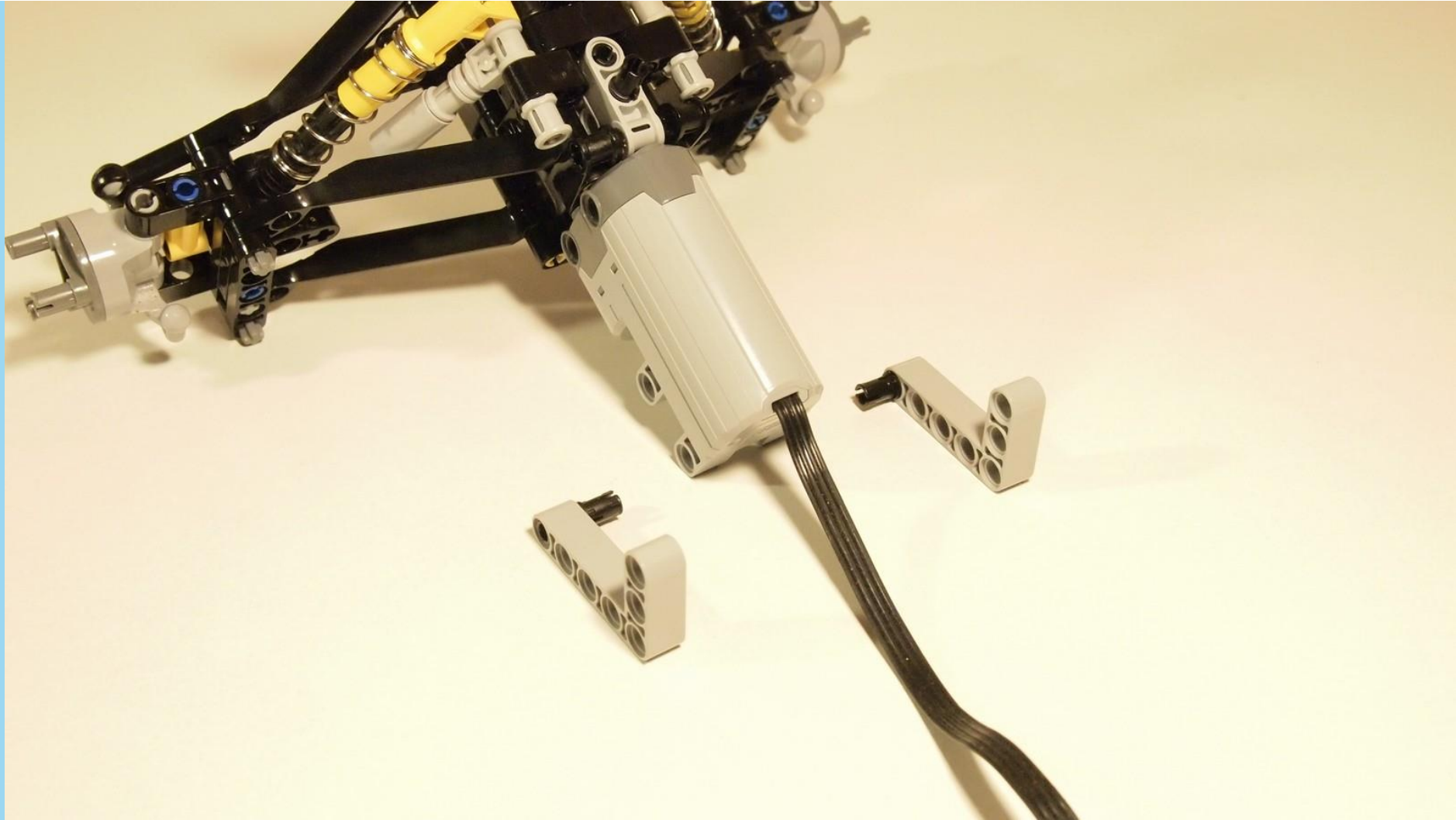

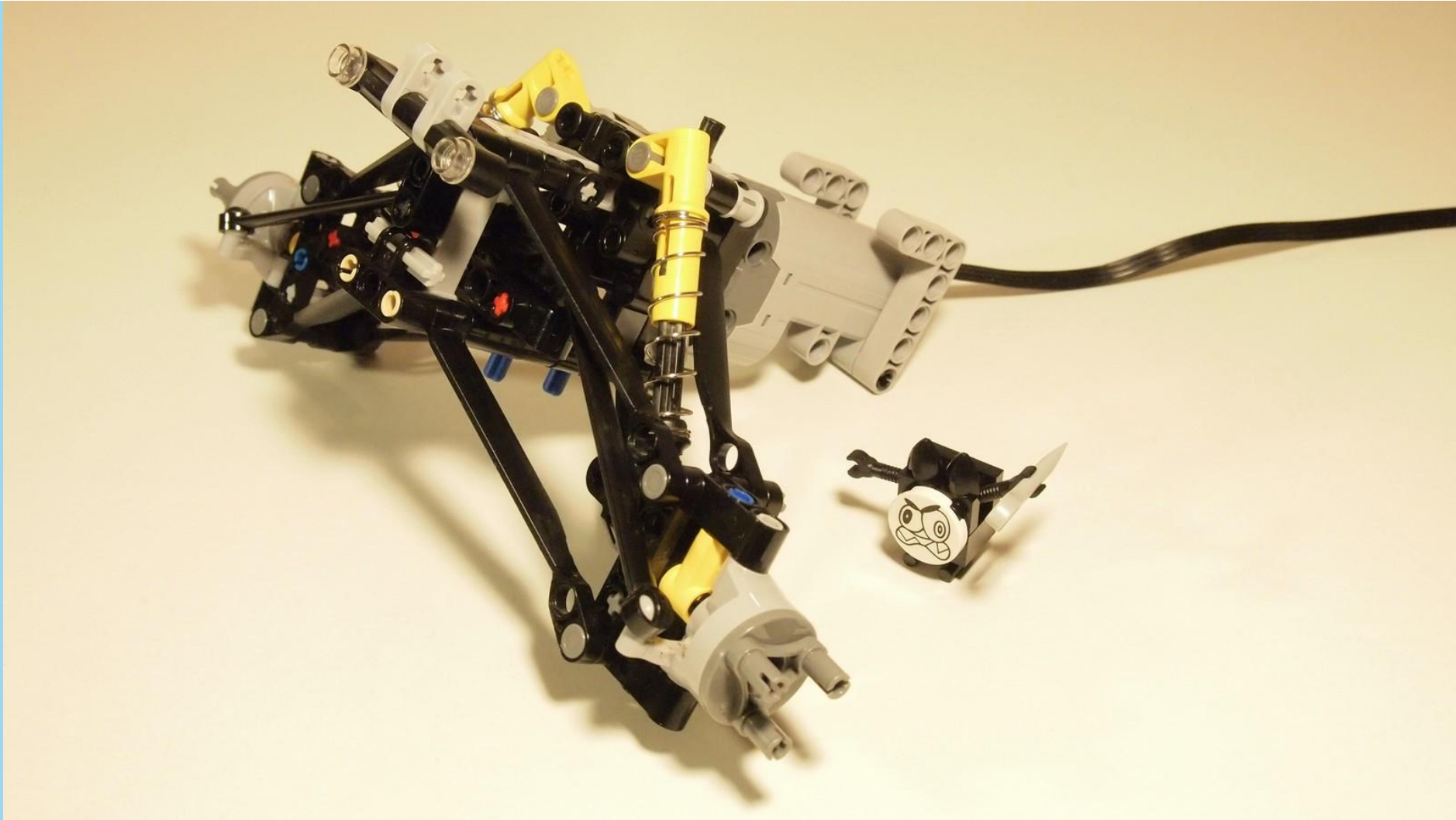

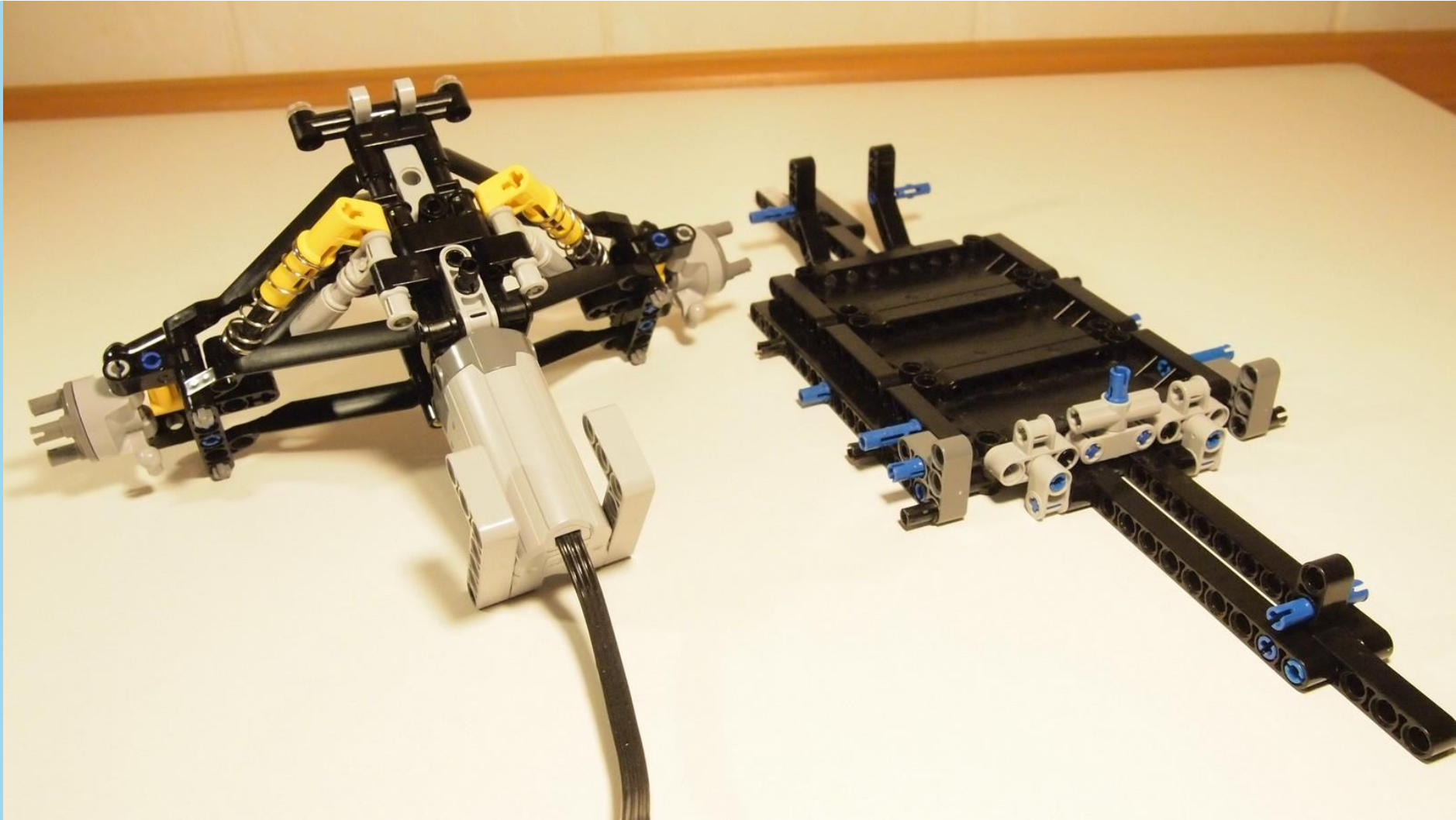

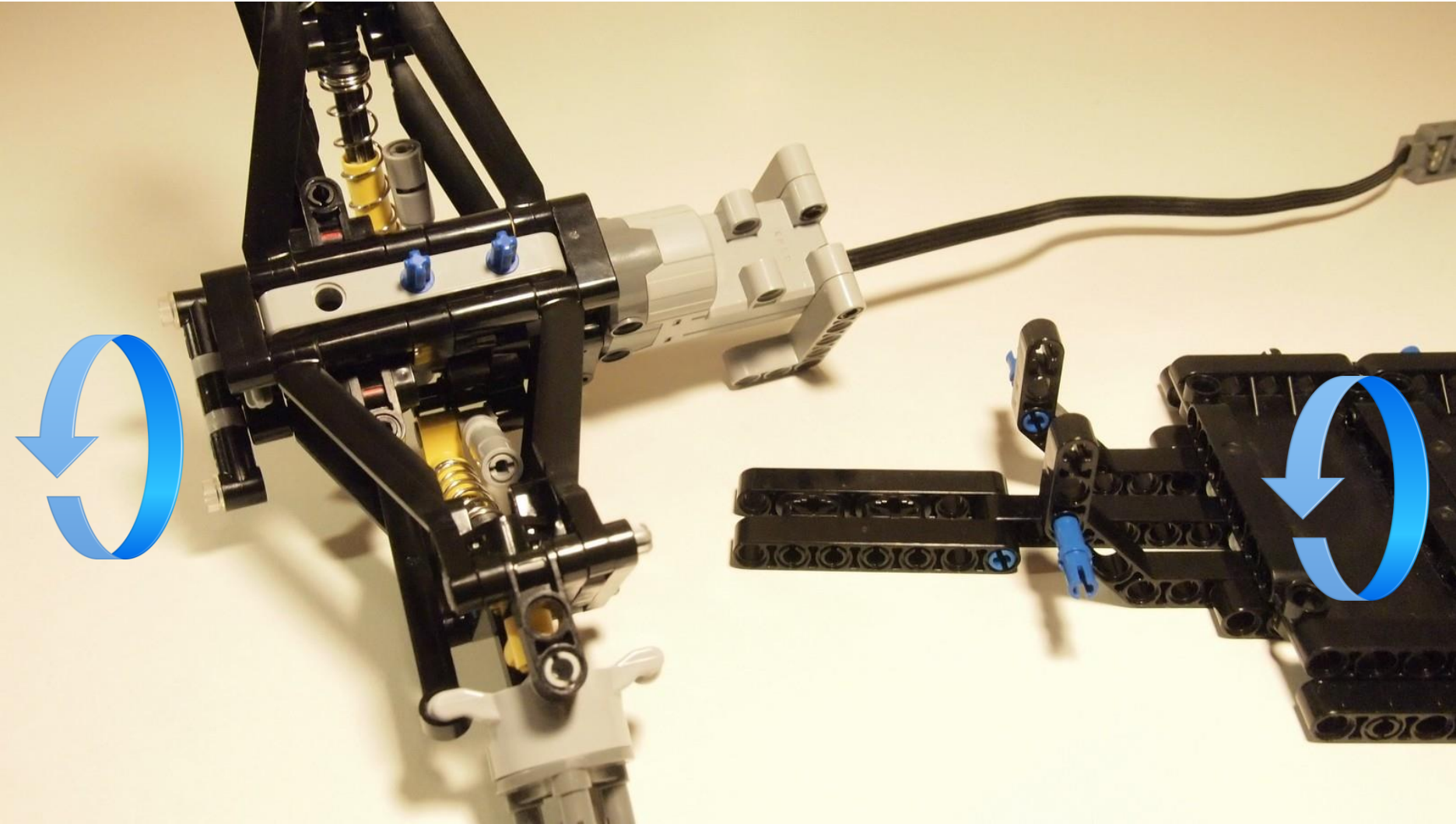

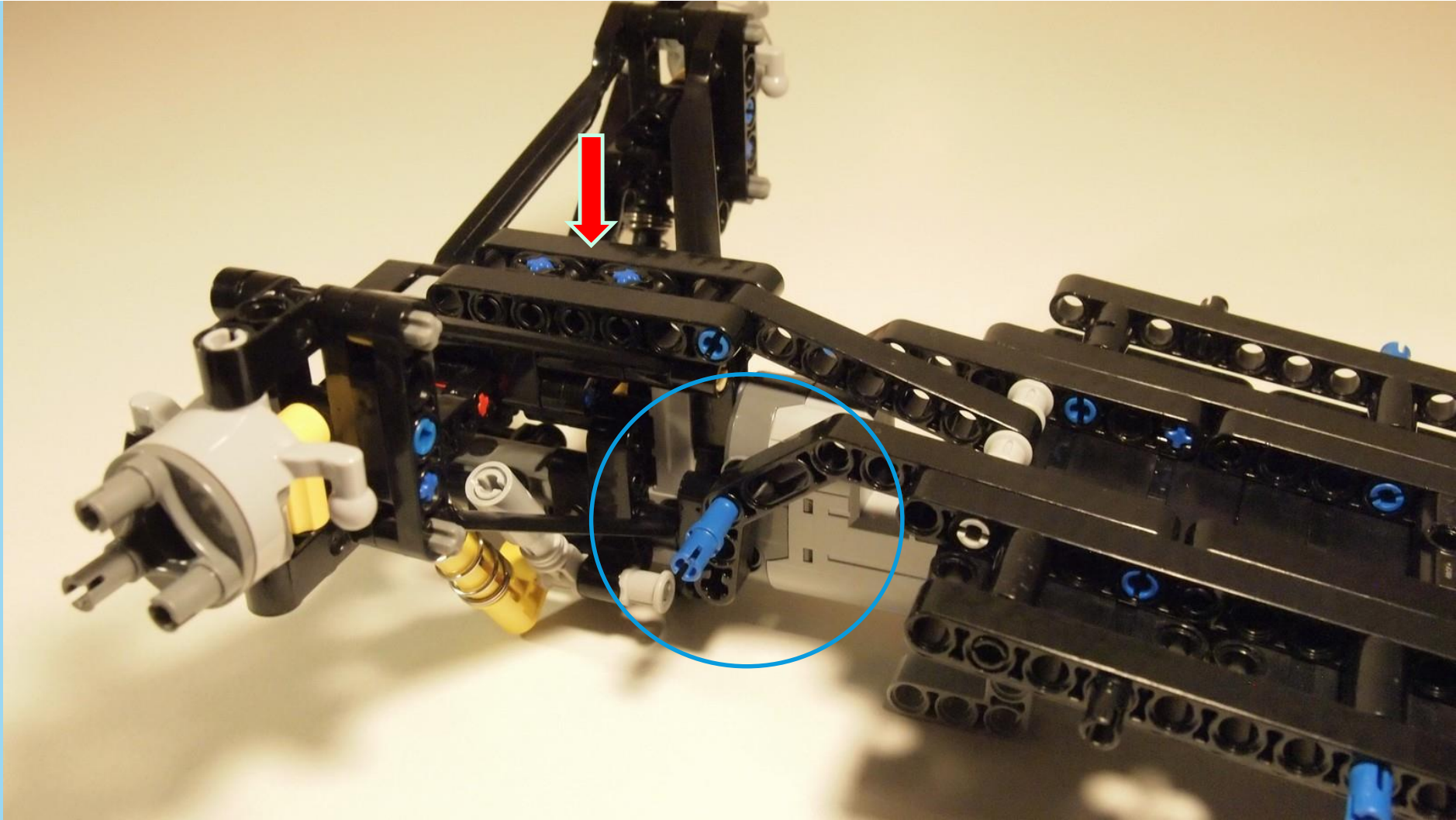

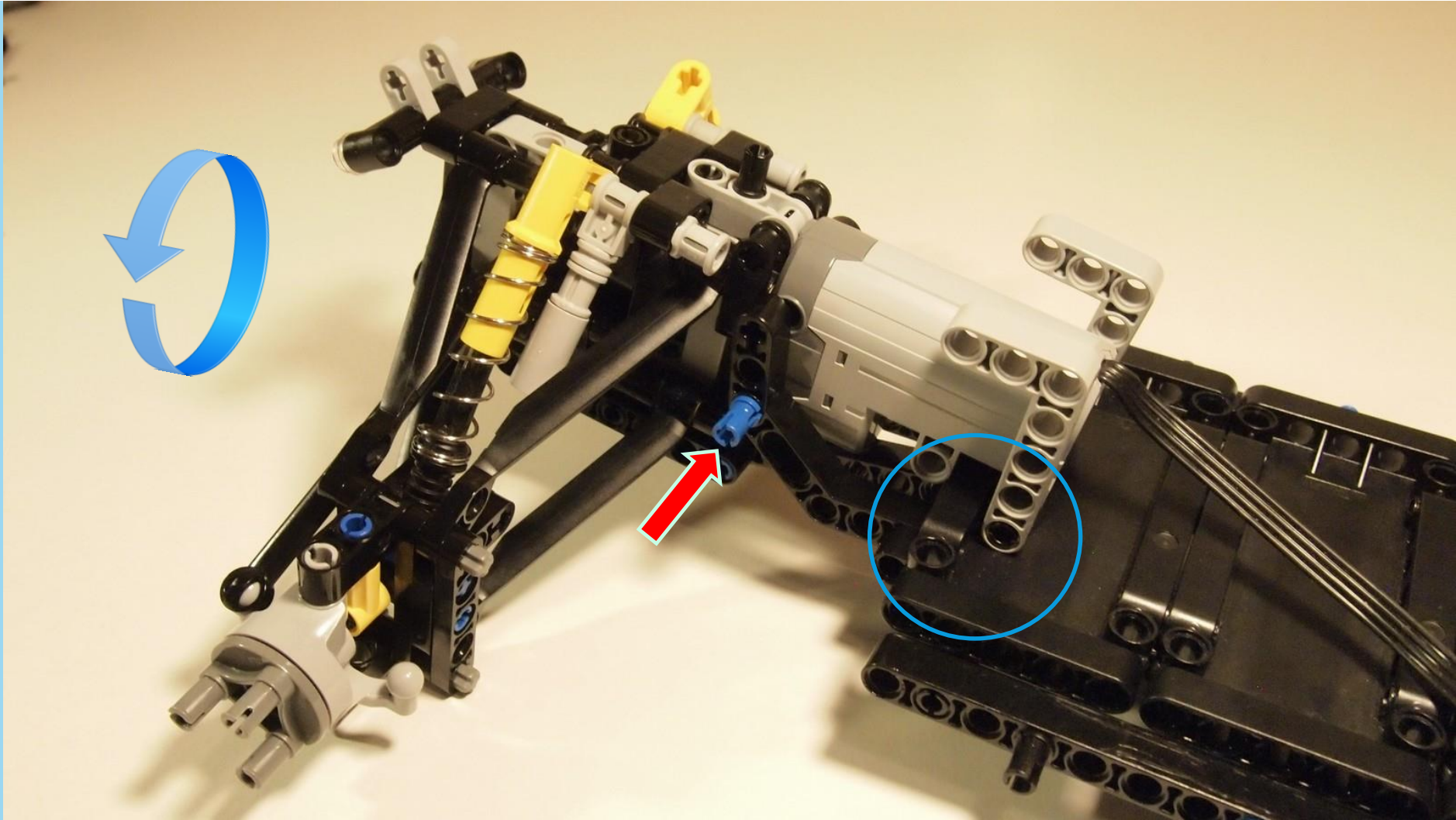

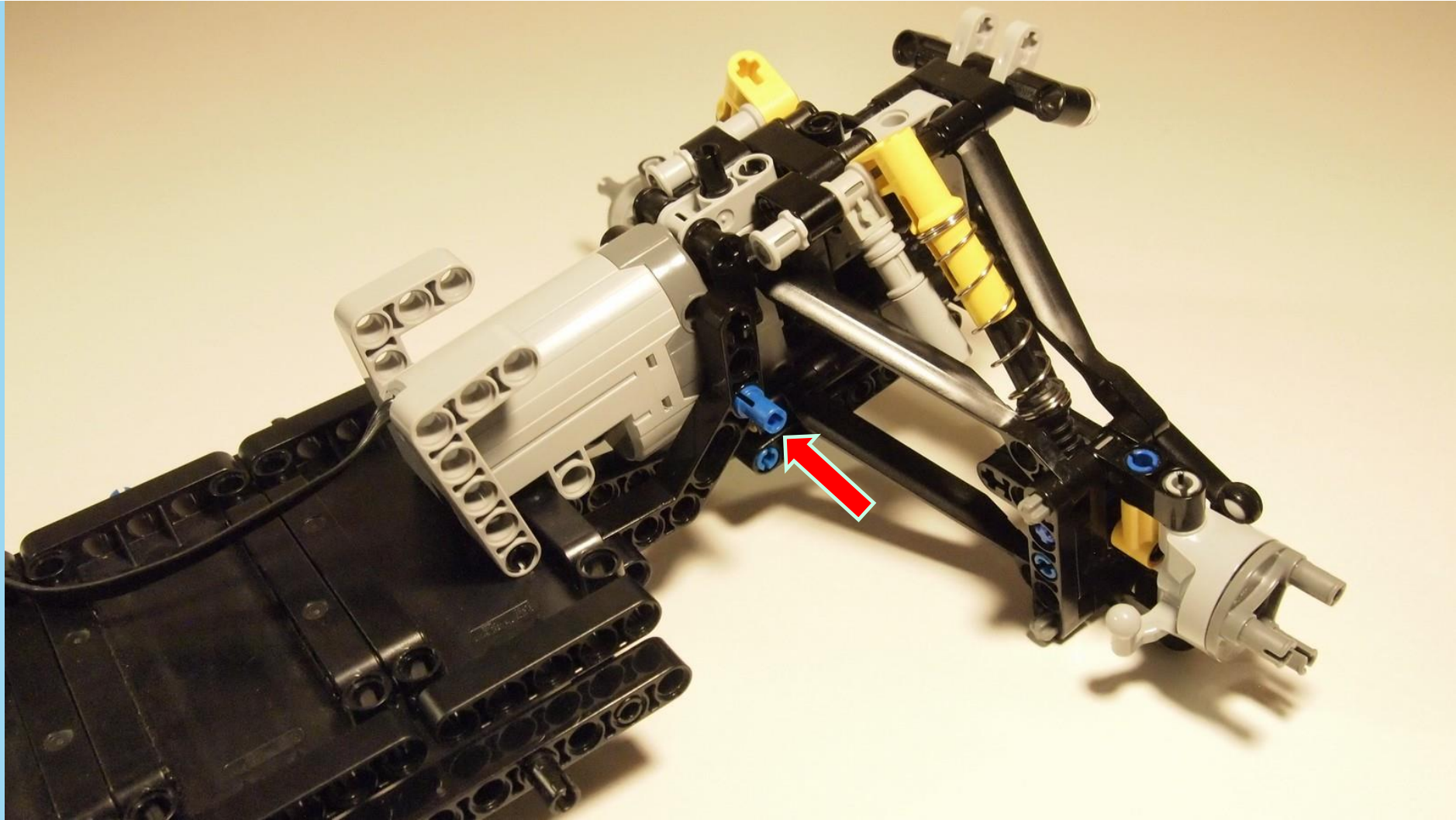



4x

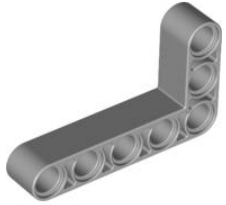

1x



1x

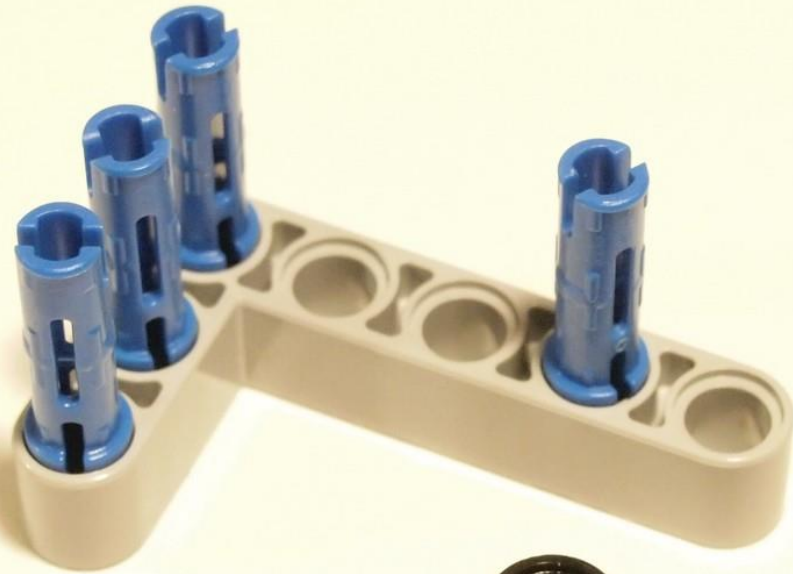





2x



1x



1x



3x





15

9

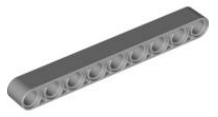

1x

1x

2x

1x



9

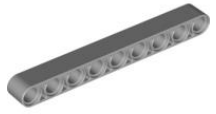

1x

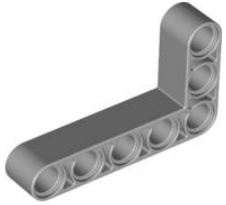

1x

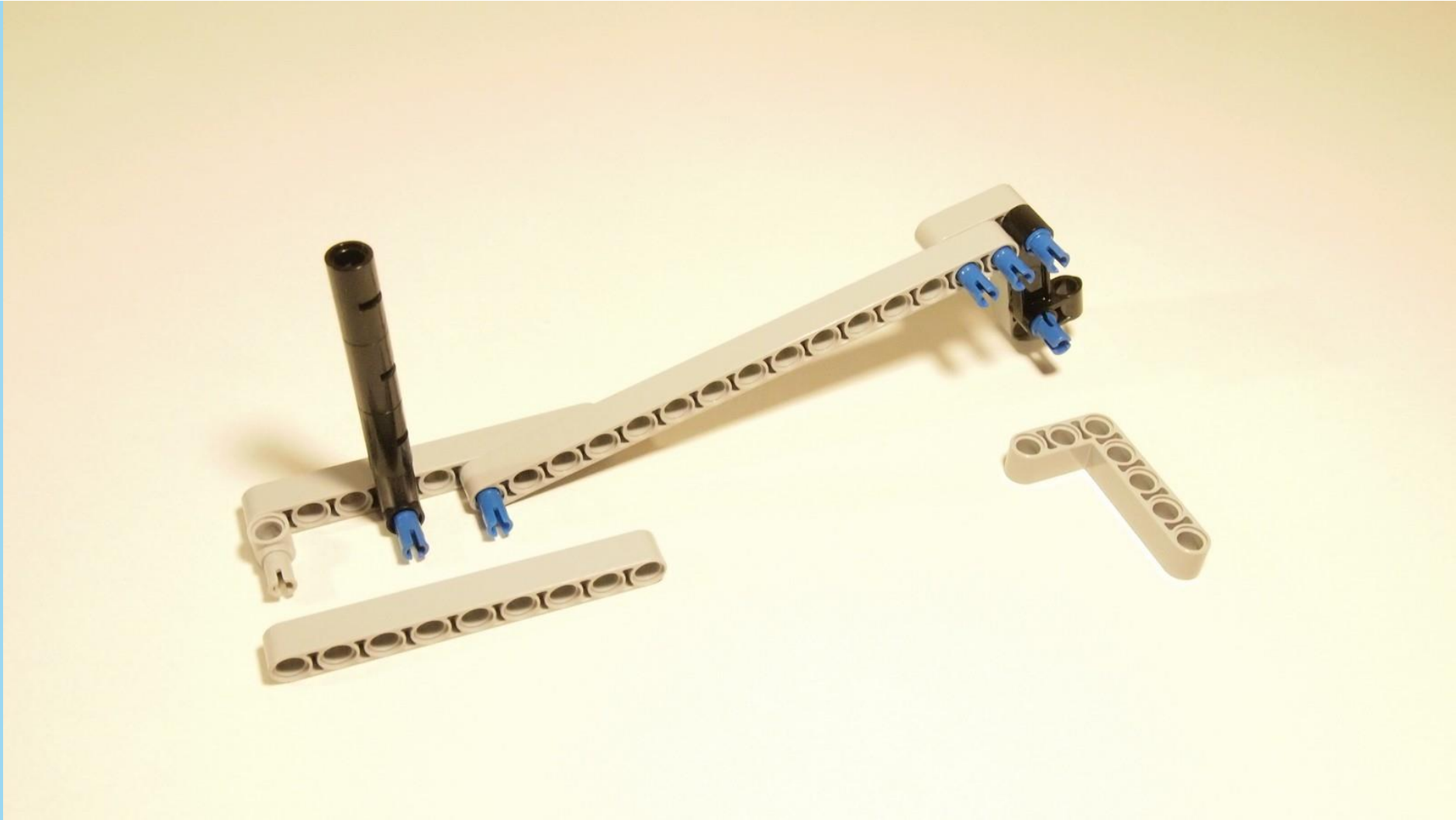

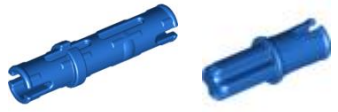

1x

1x

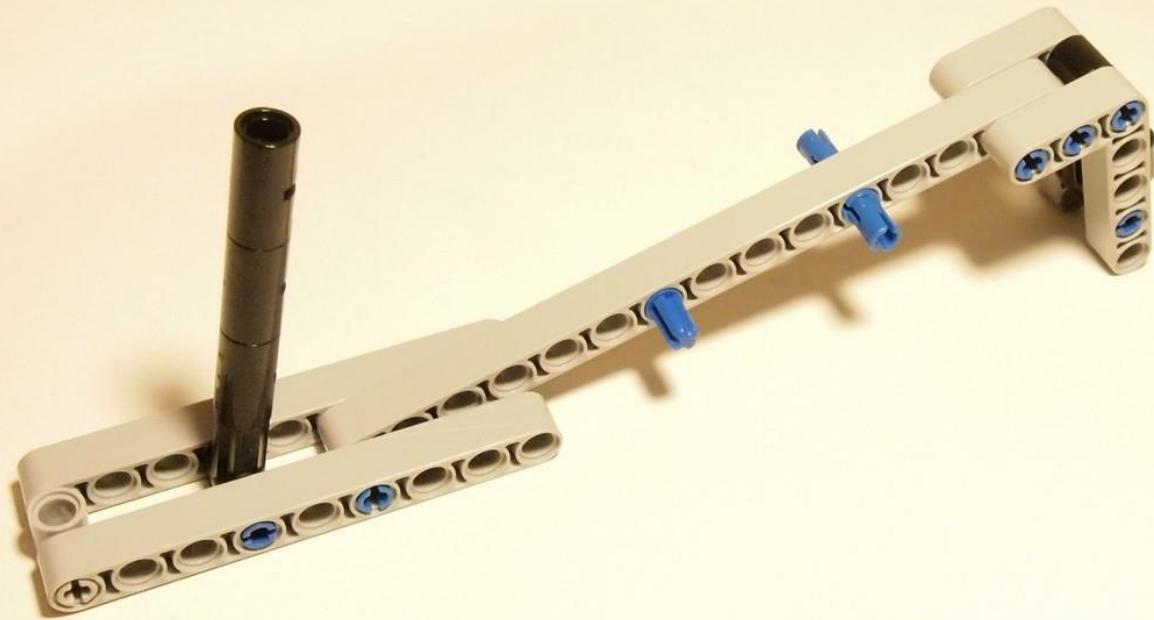



4x



2x



4x



2x



2x



2x





freeinstruction
This is a free document - should not spread for money!



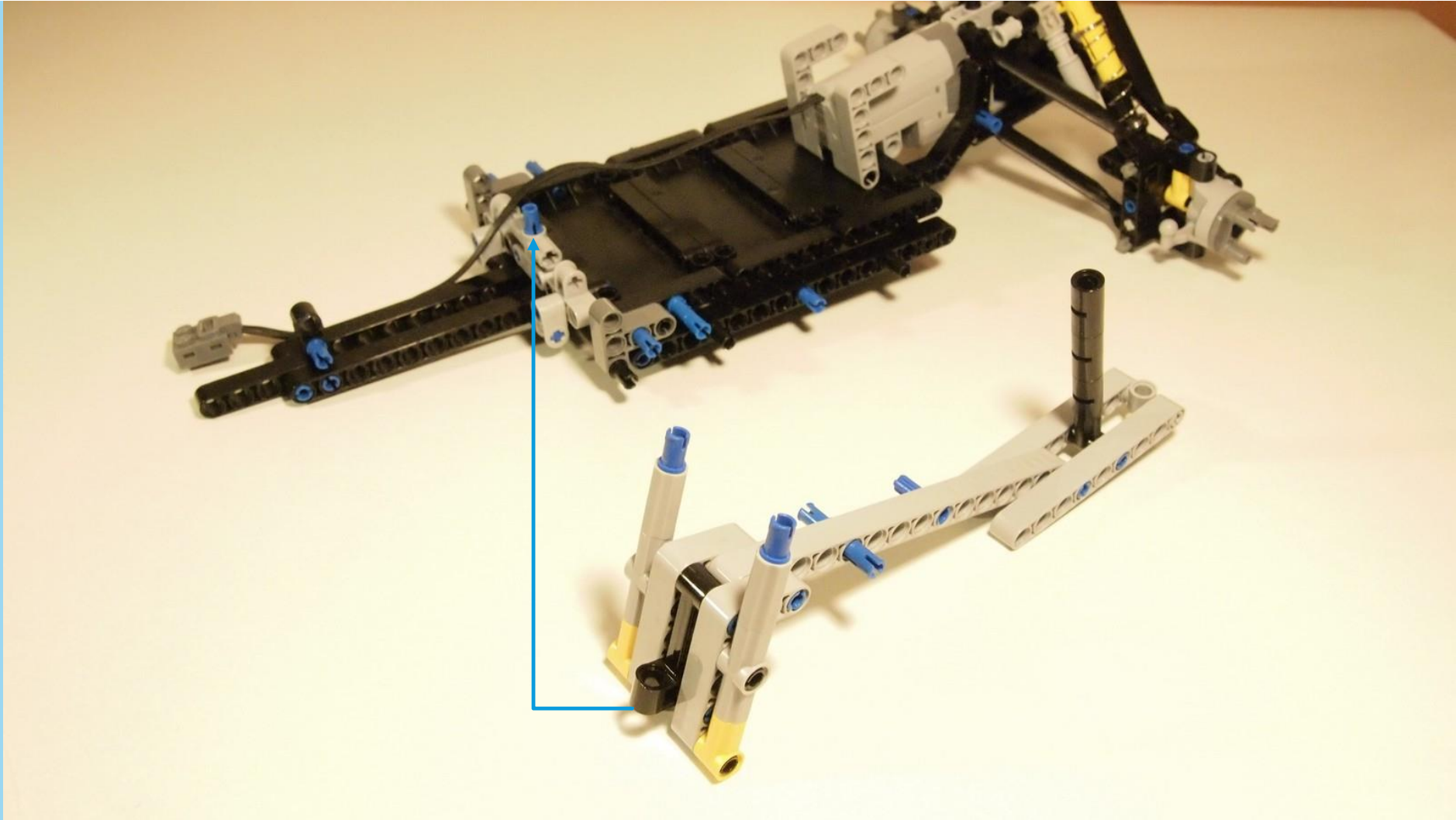

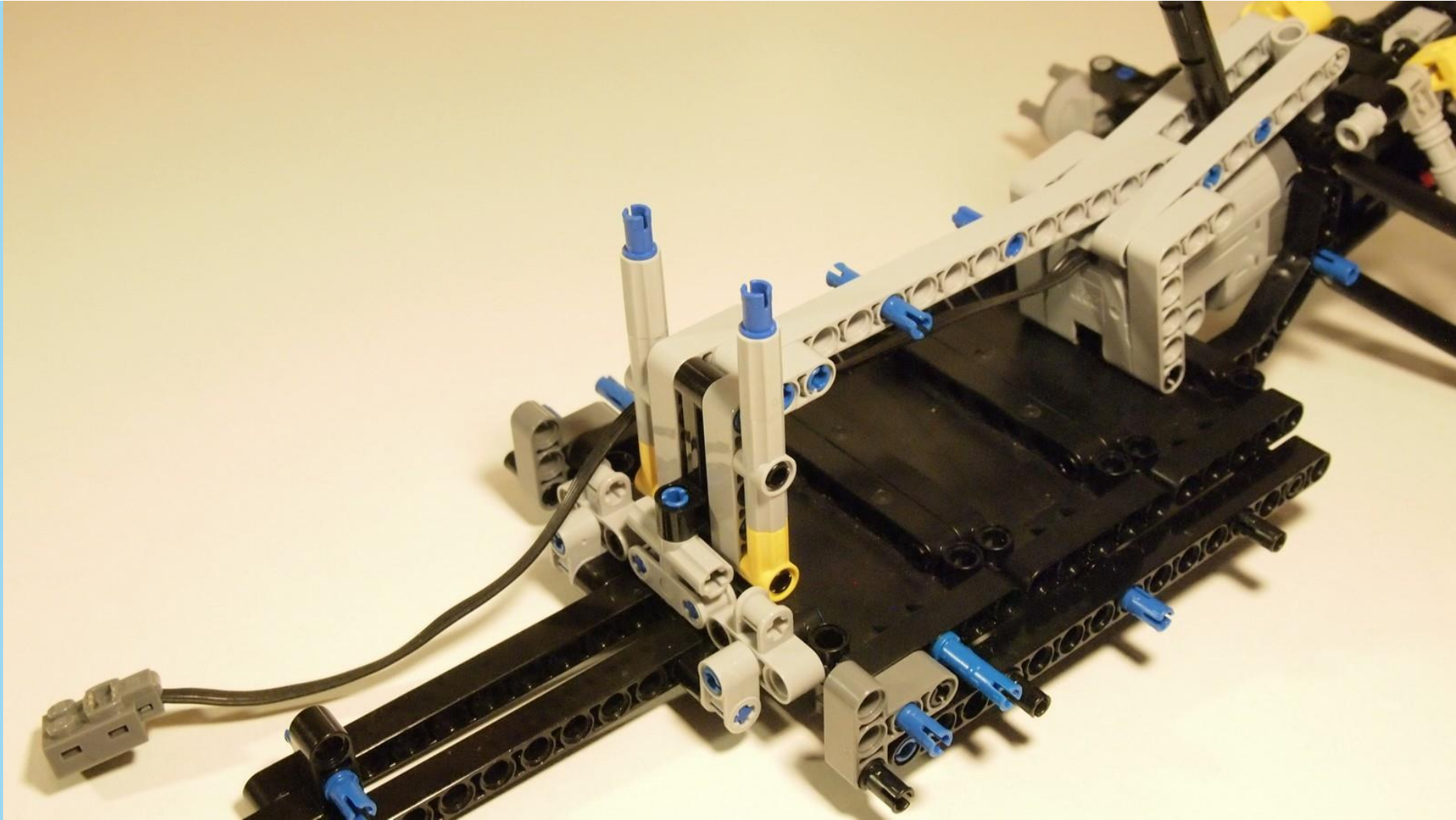

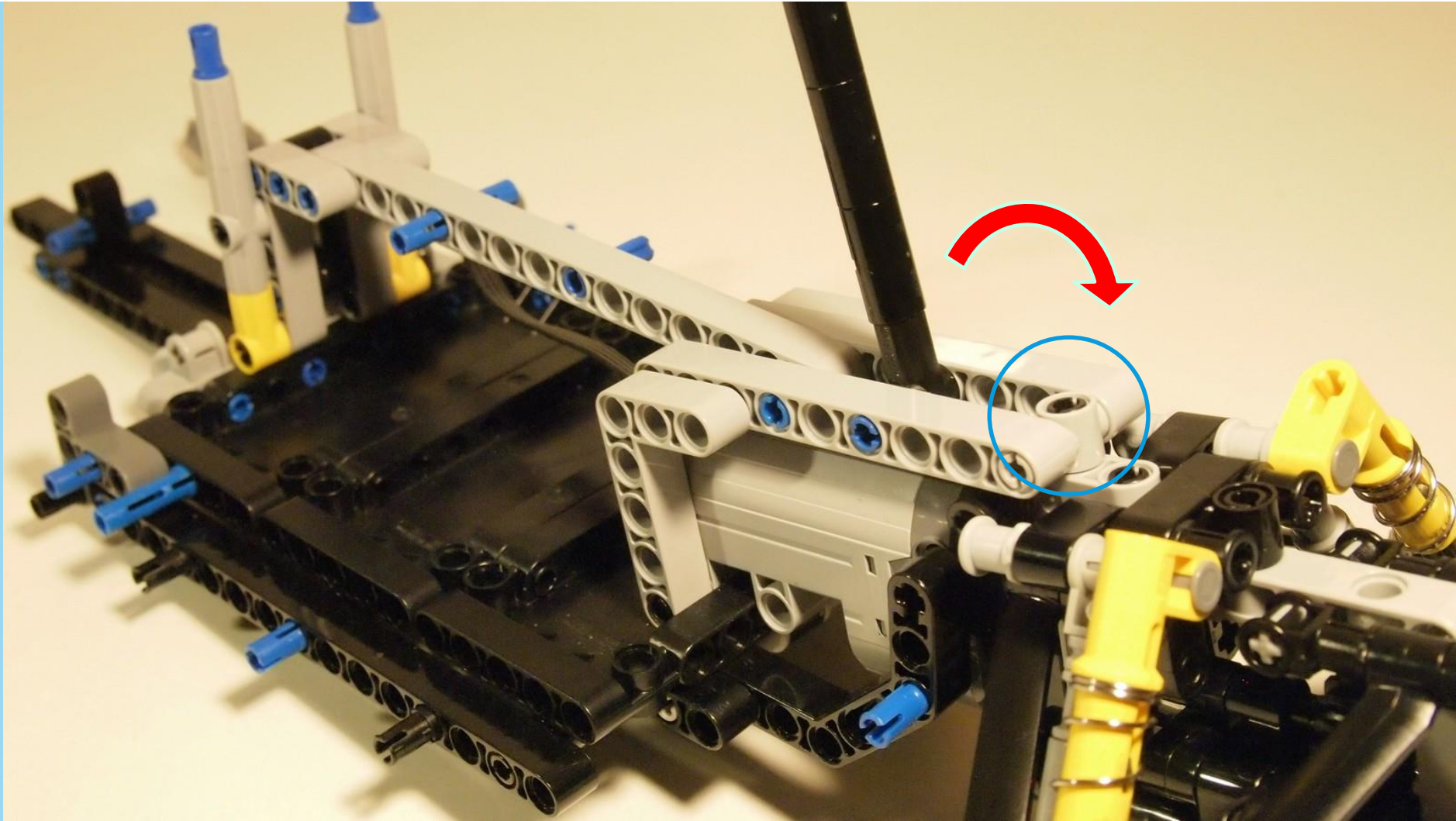



4x

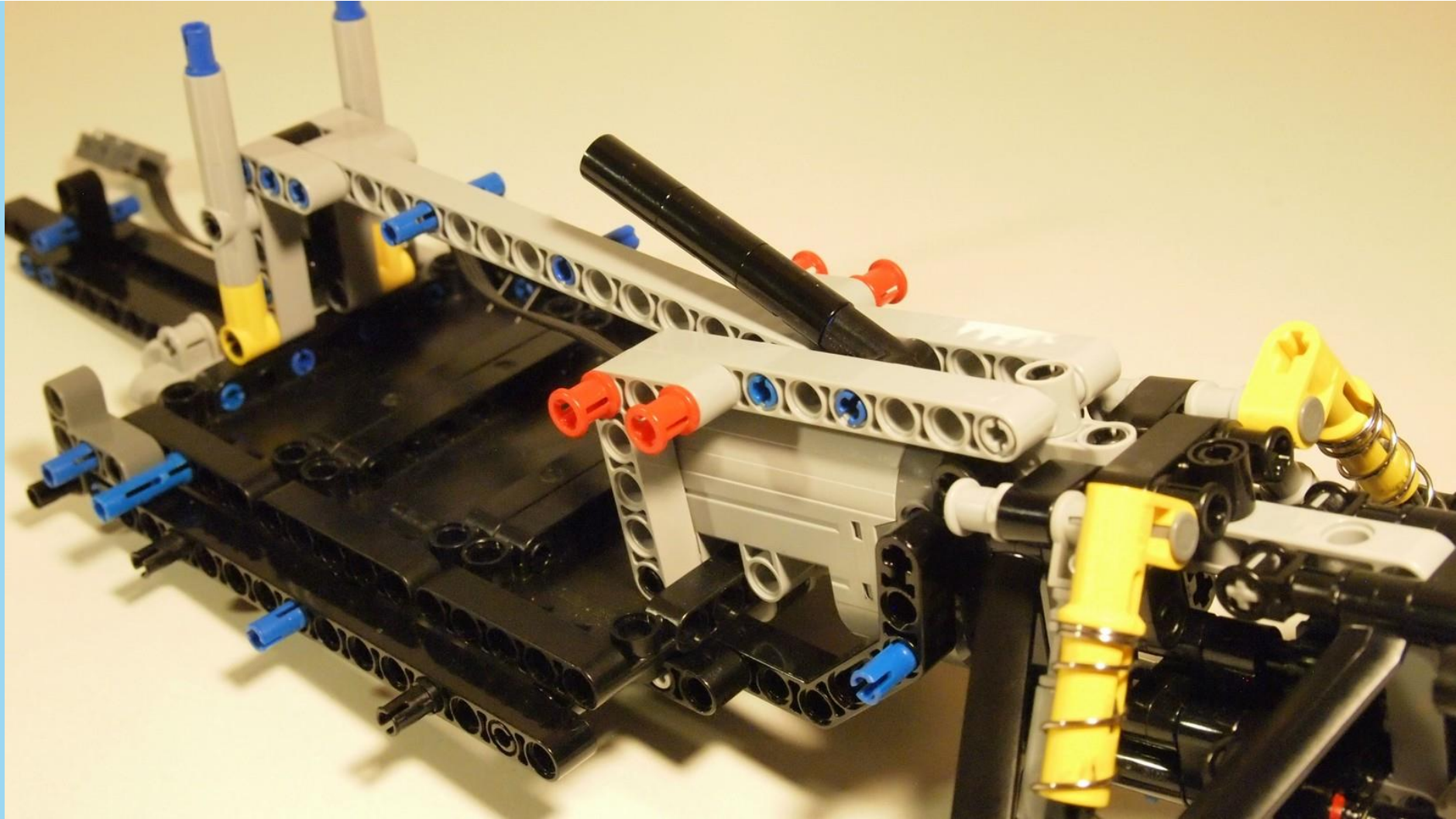



1x



1x

5



2x

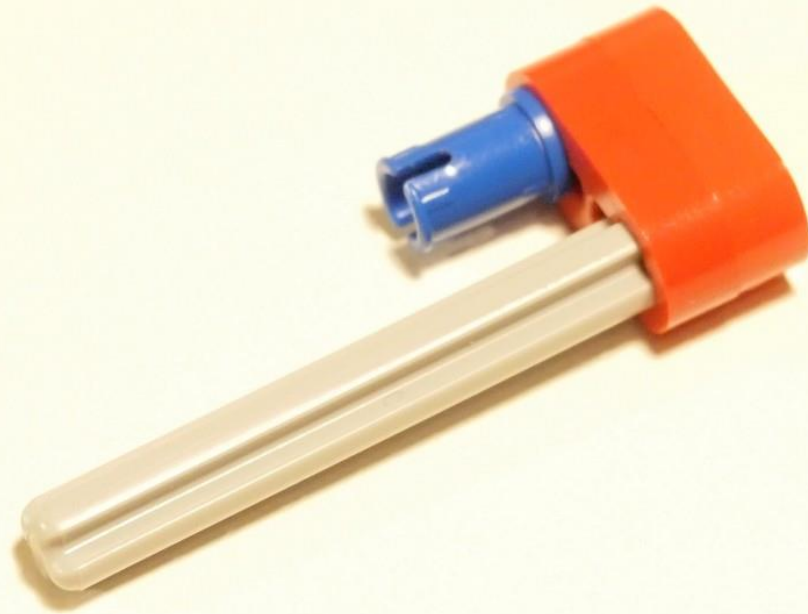

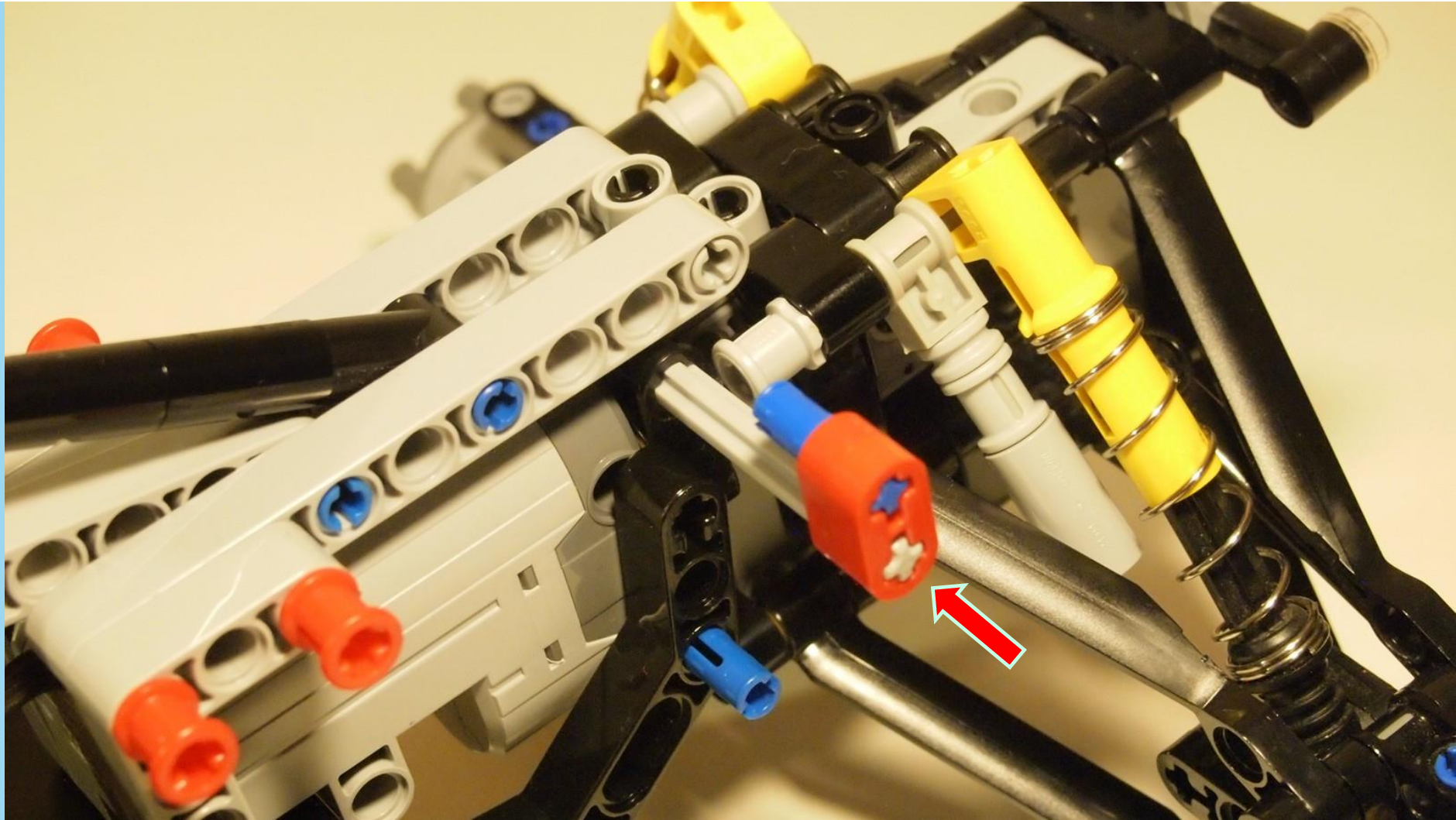

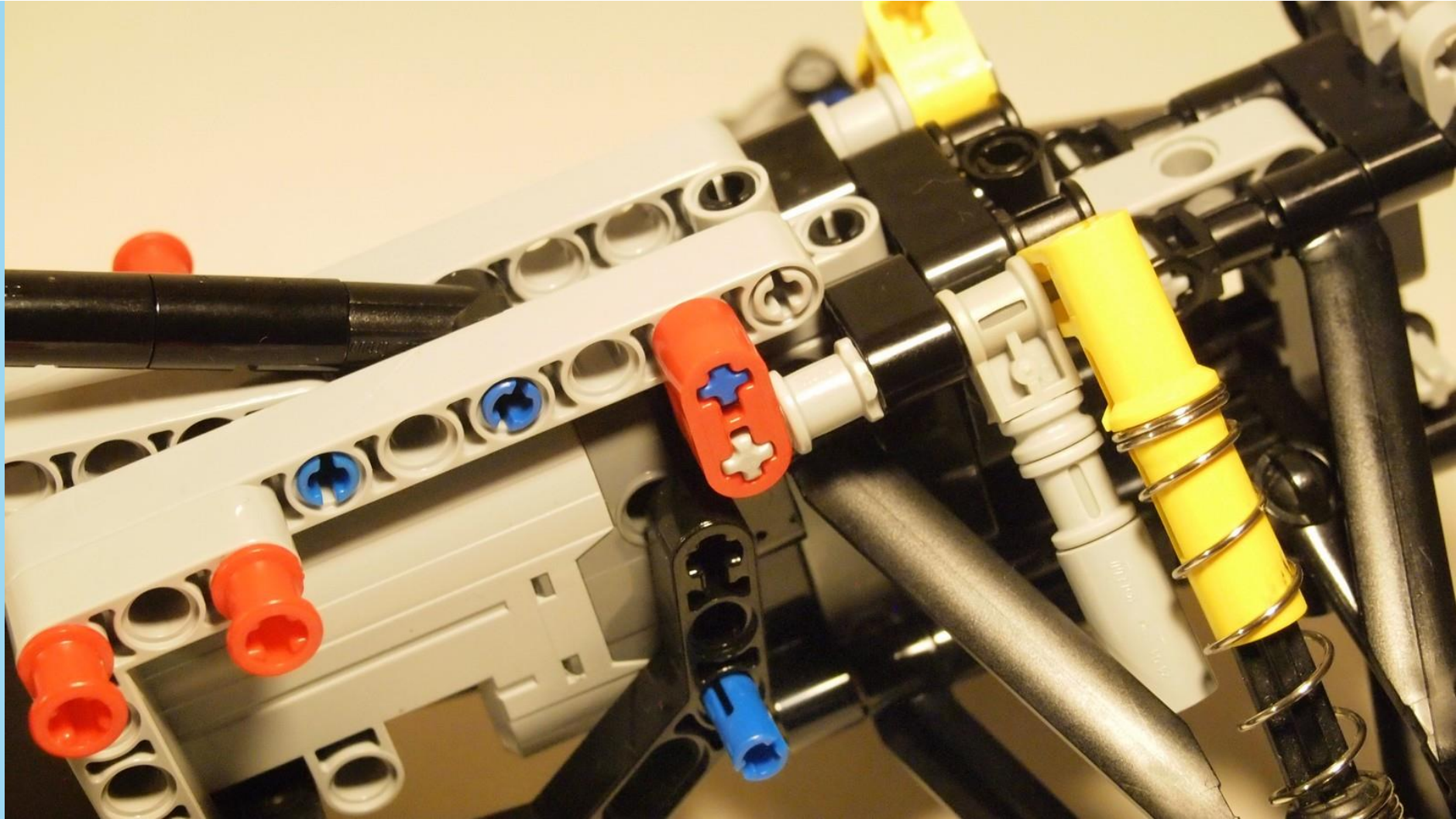



1x



2x

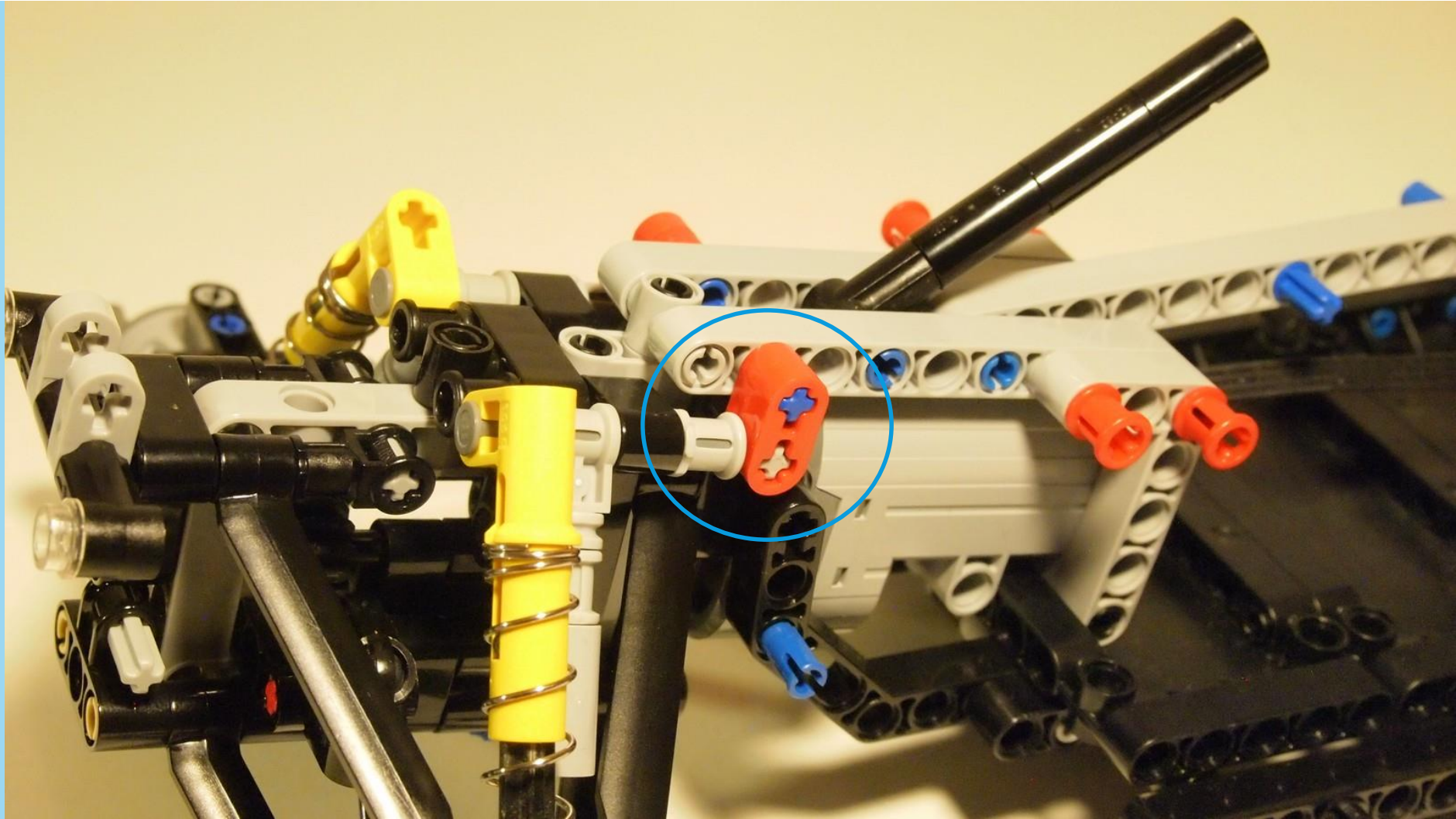



2x



2x

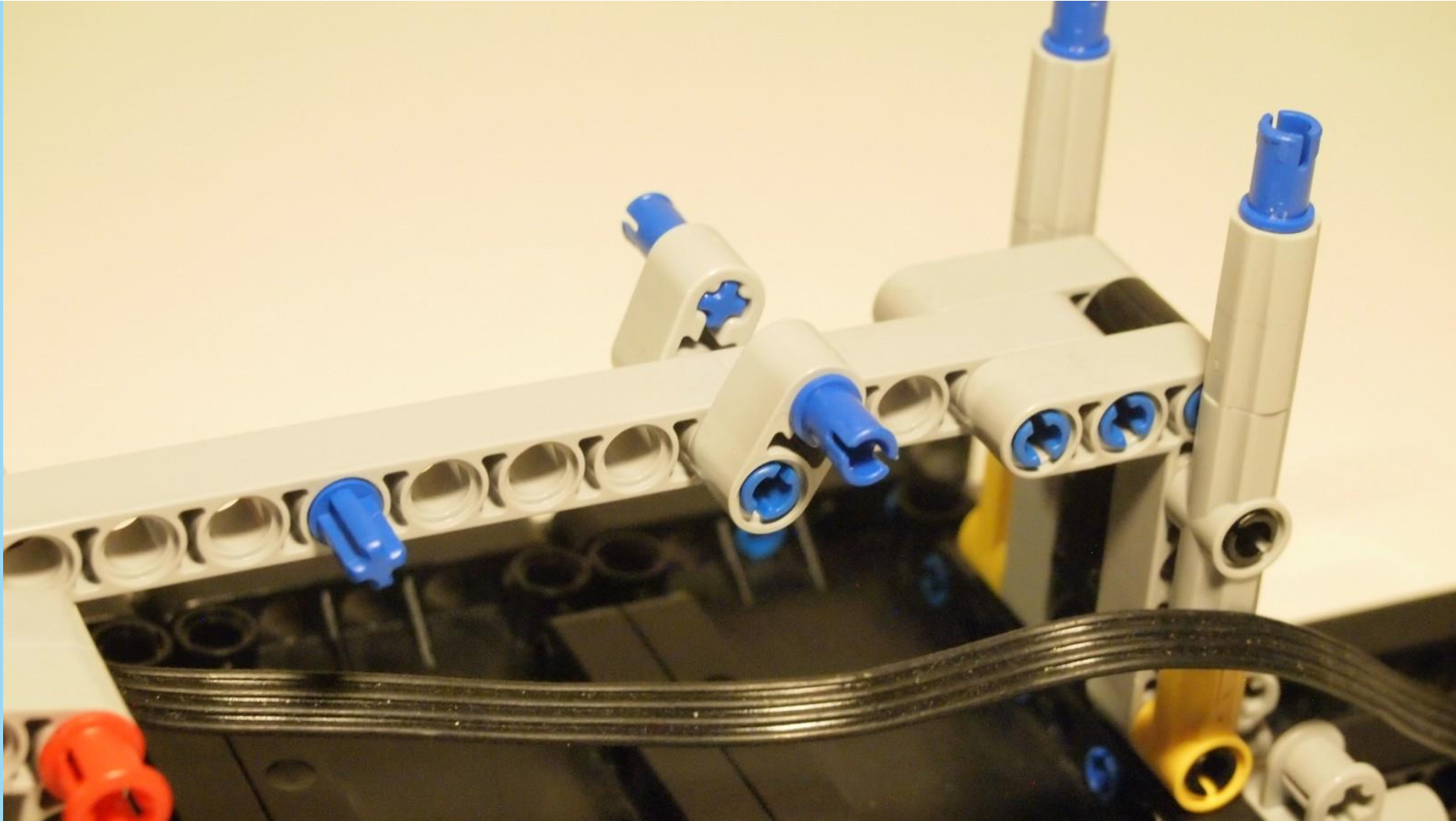



1x



1x

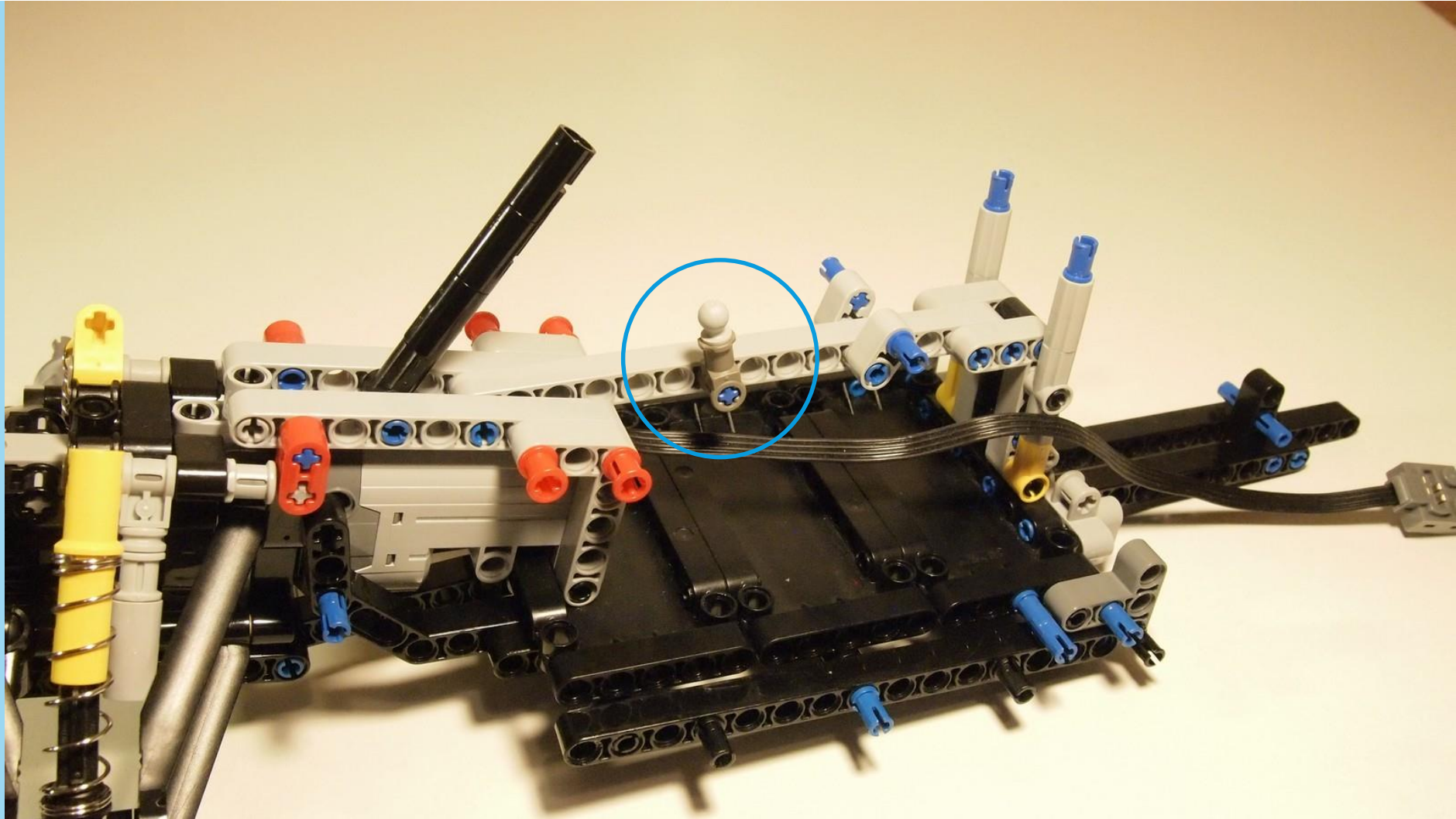

11



1x



1x

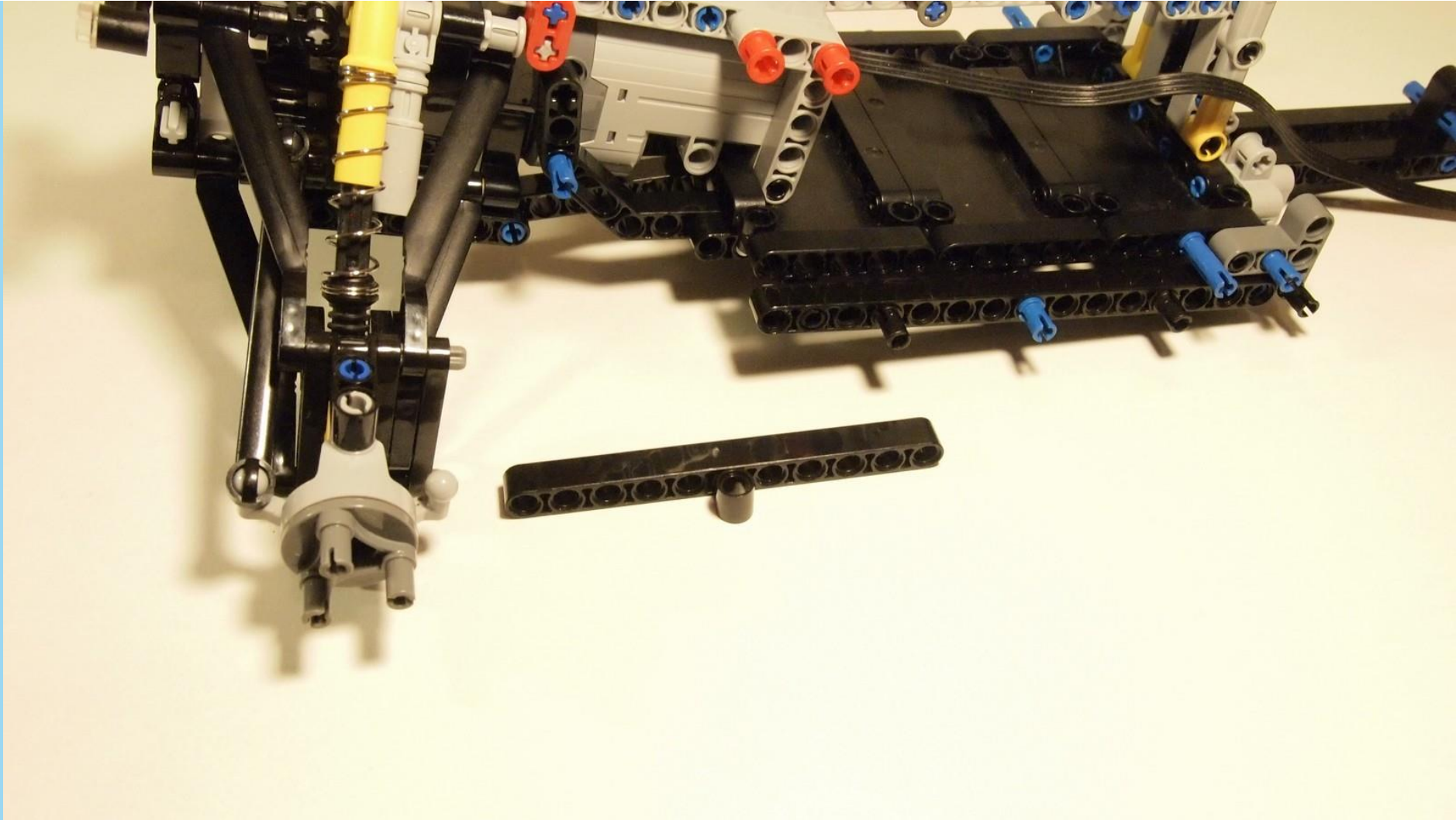

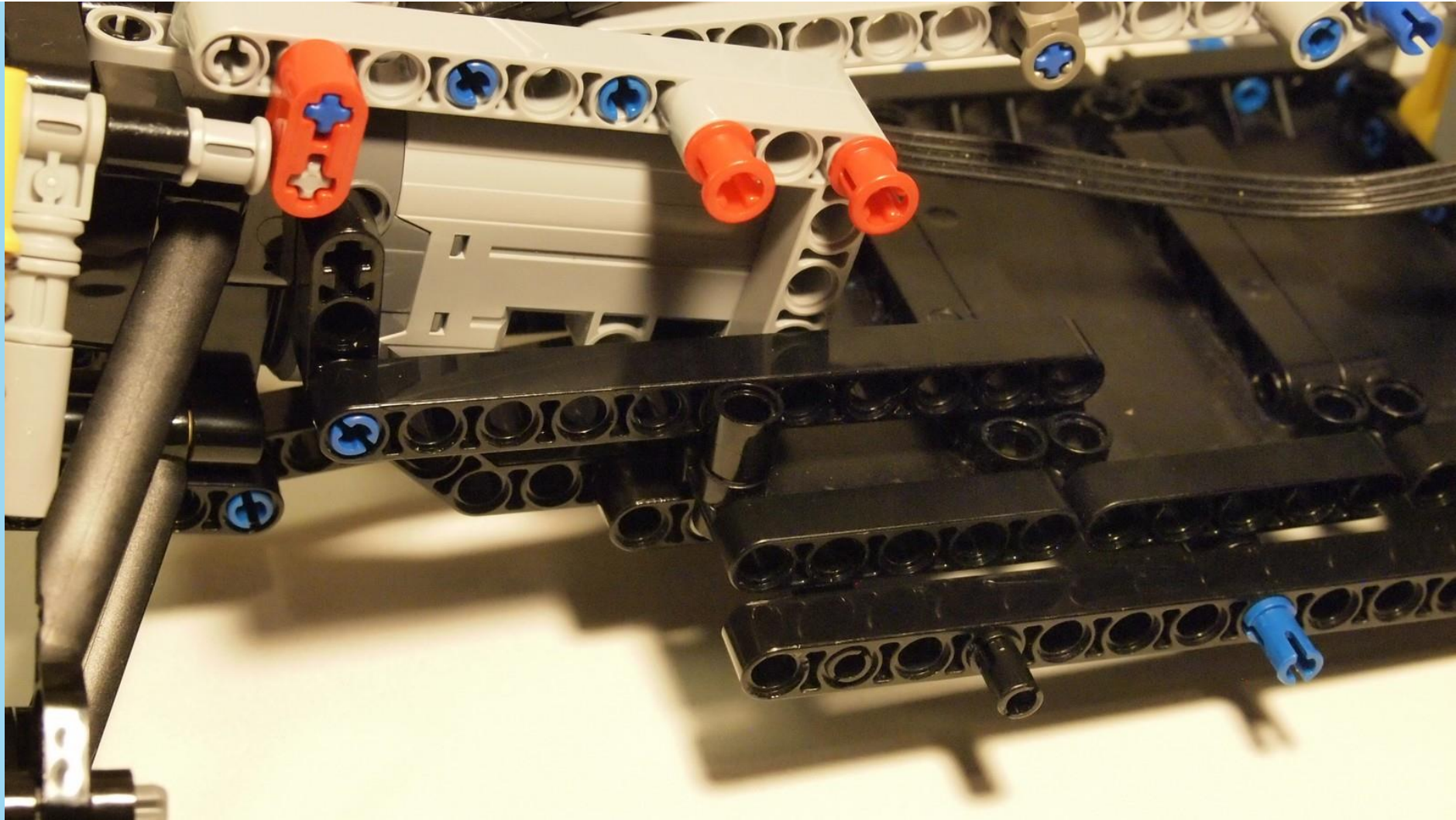

11



1x



1x

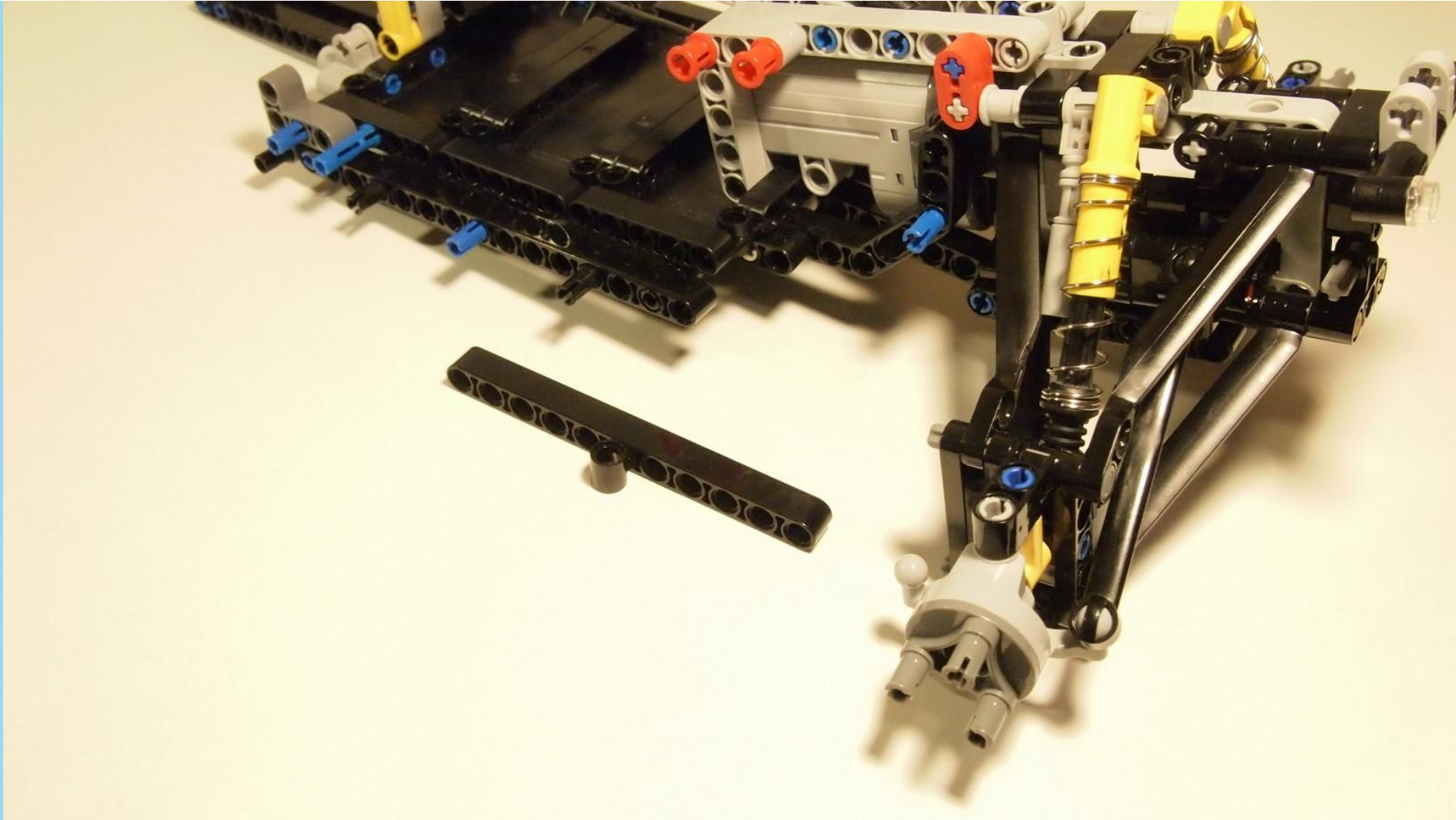

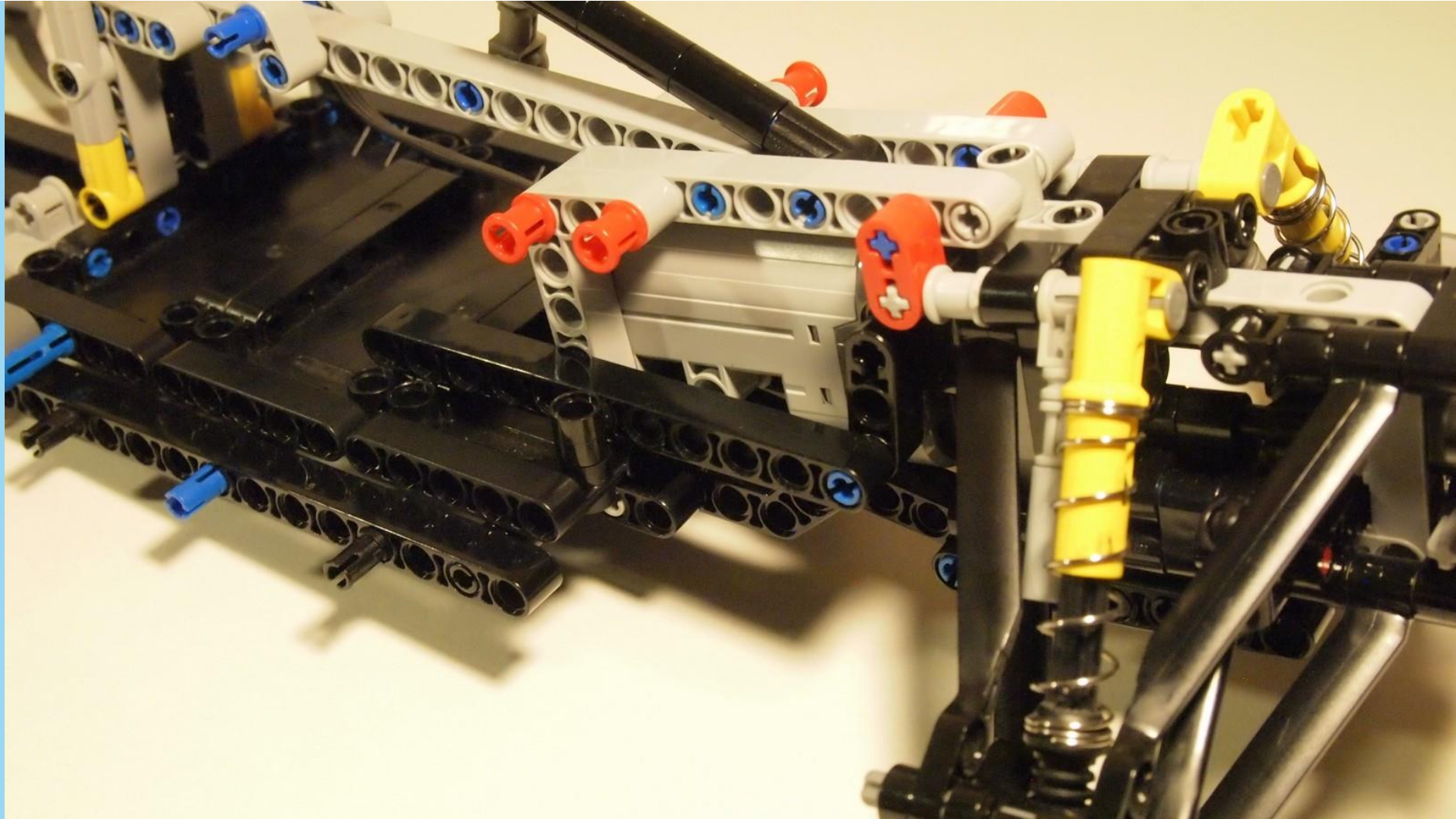



2x

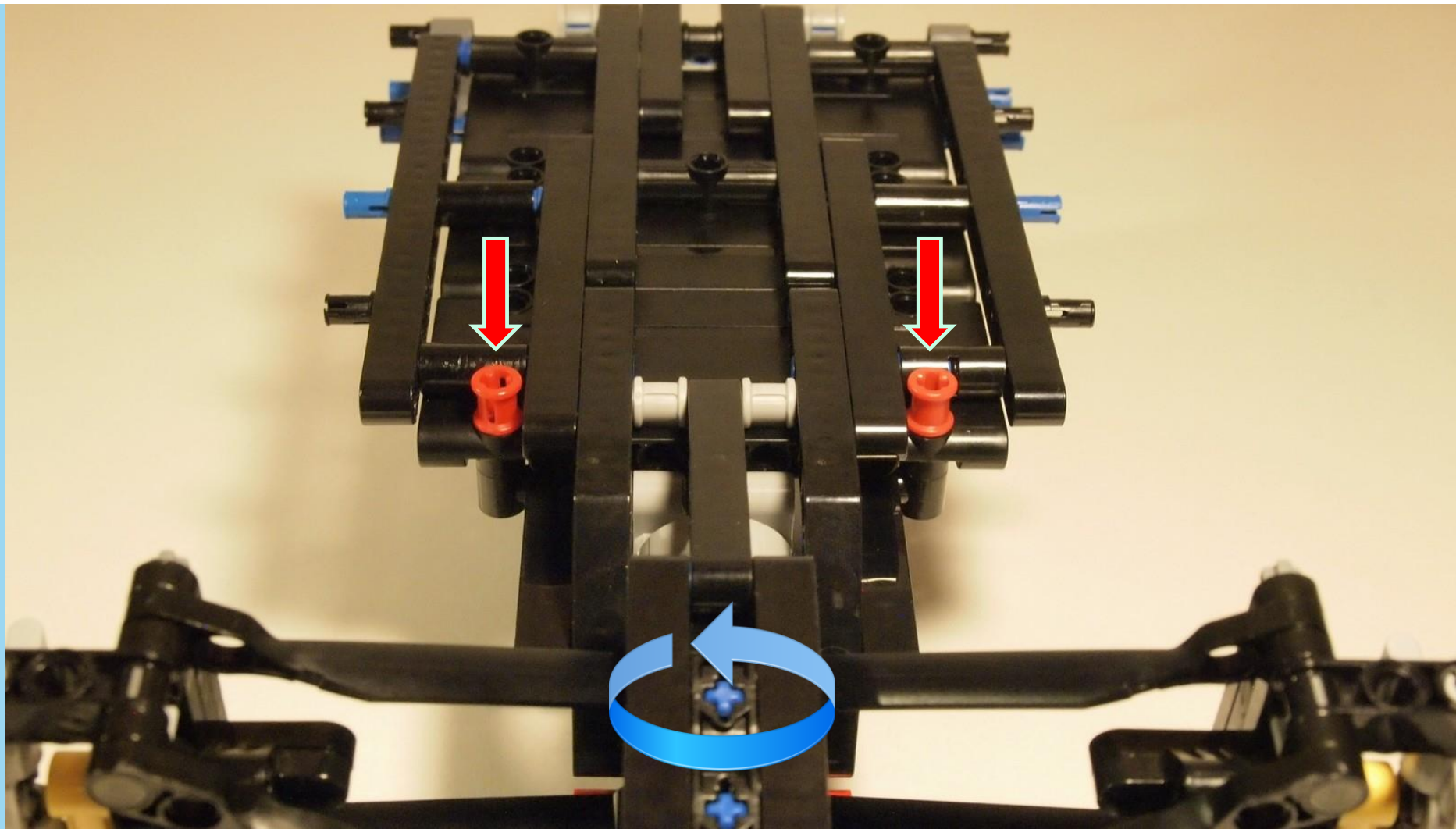



2x

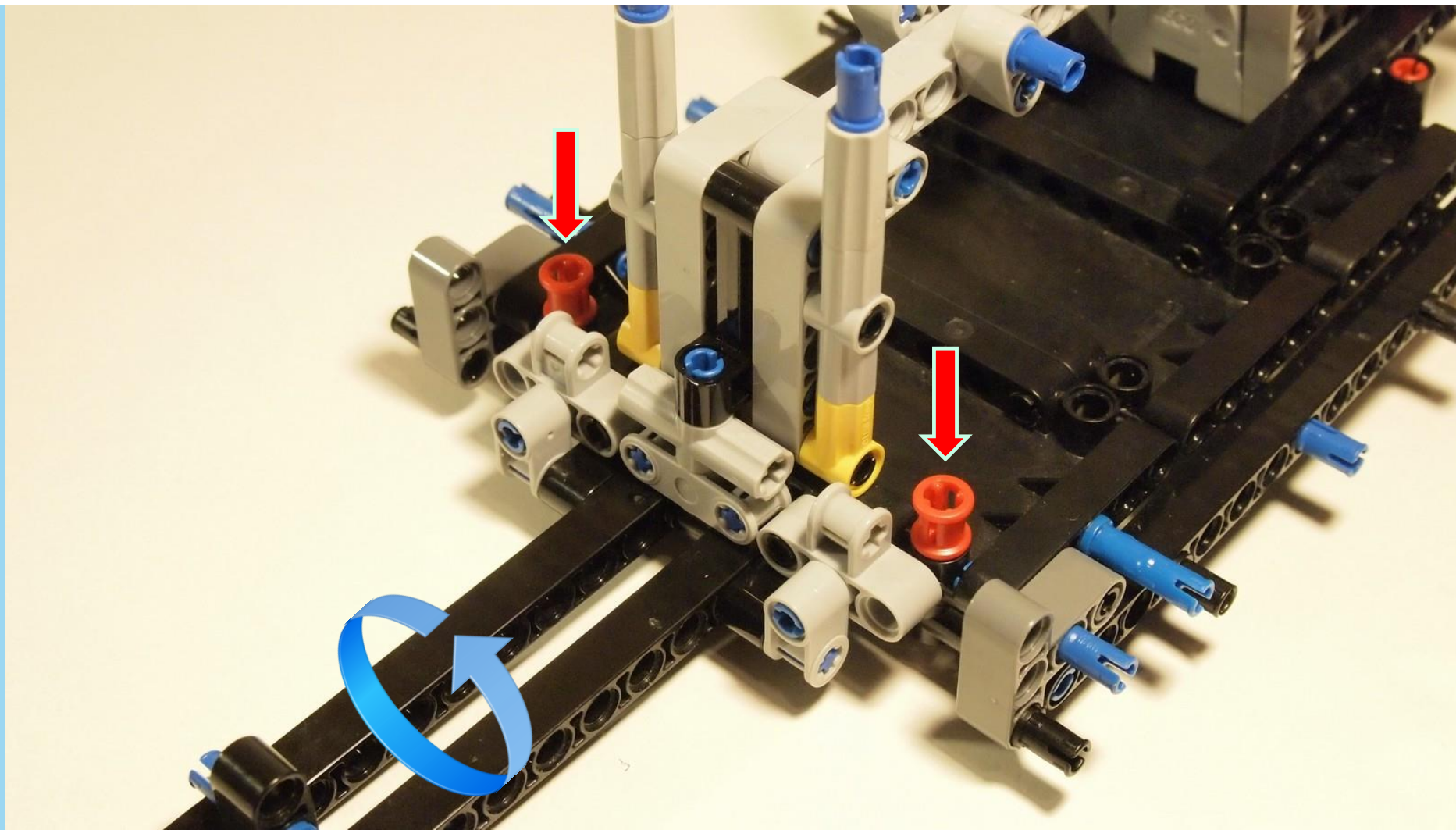

15



1x



4x



2x



2x



2x



1x

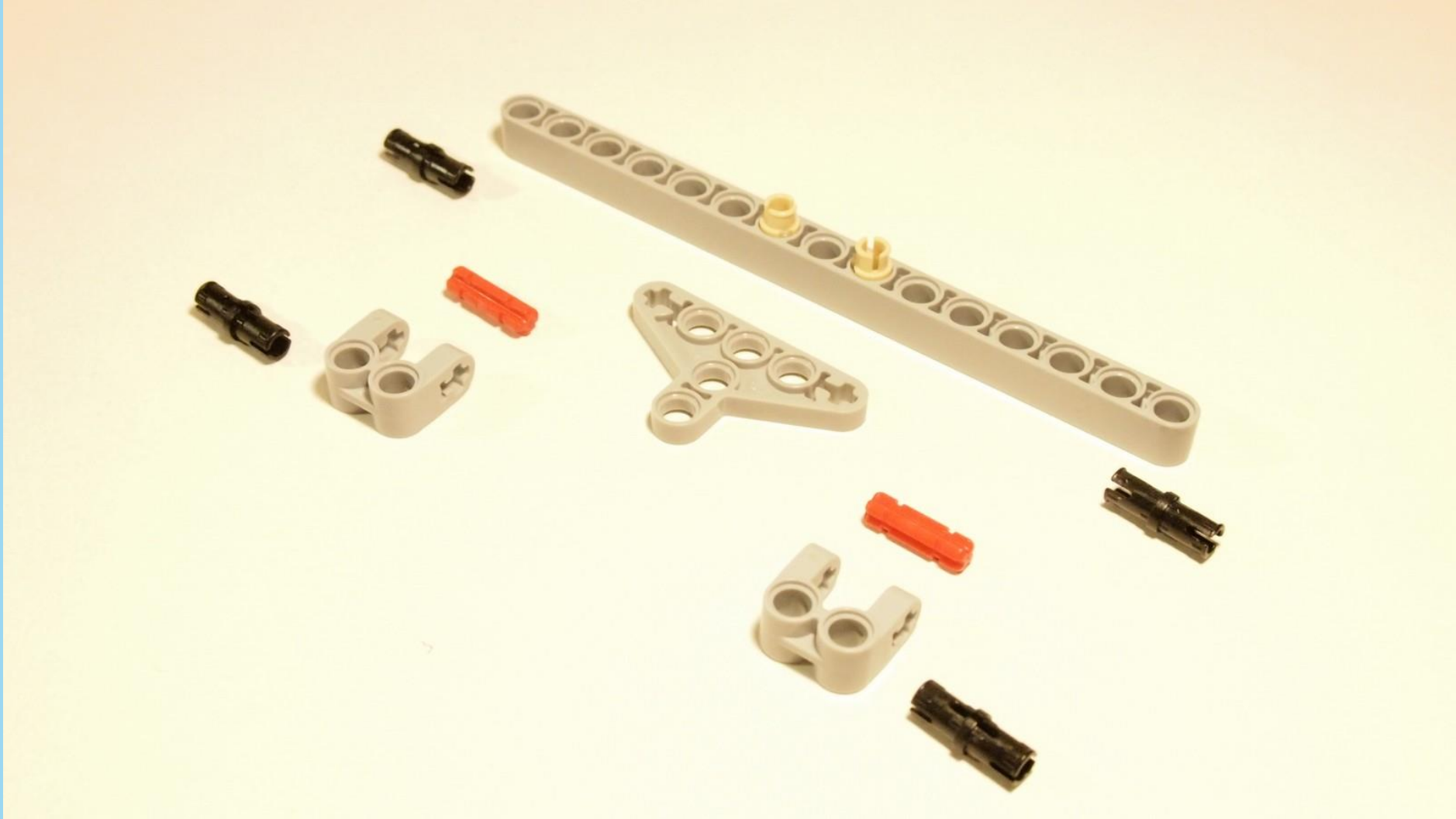



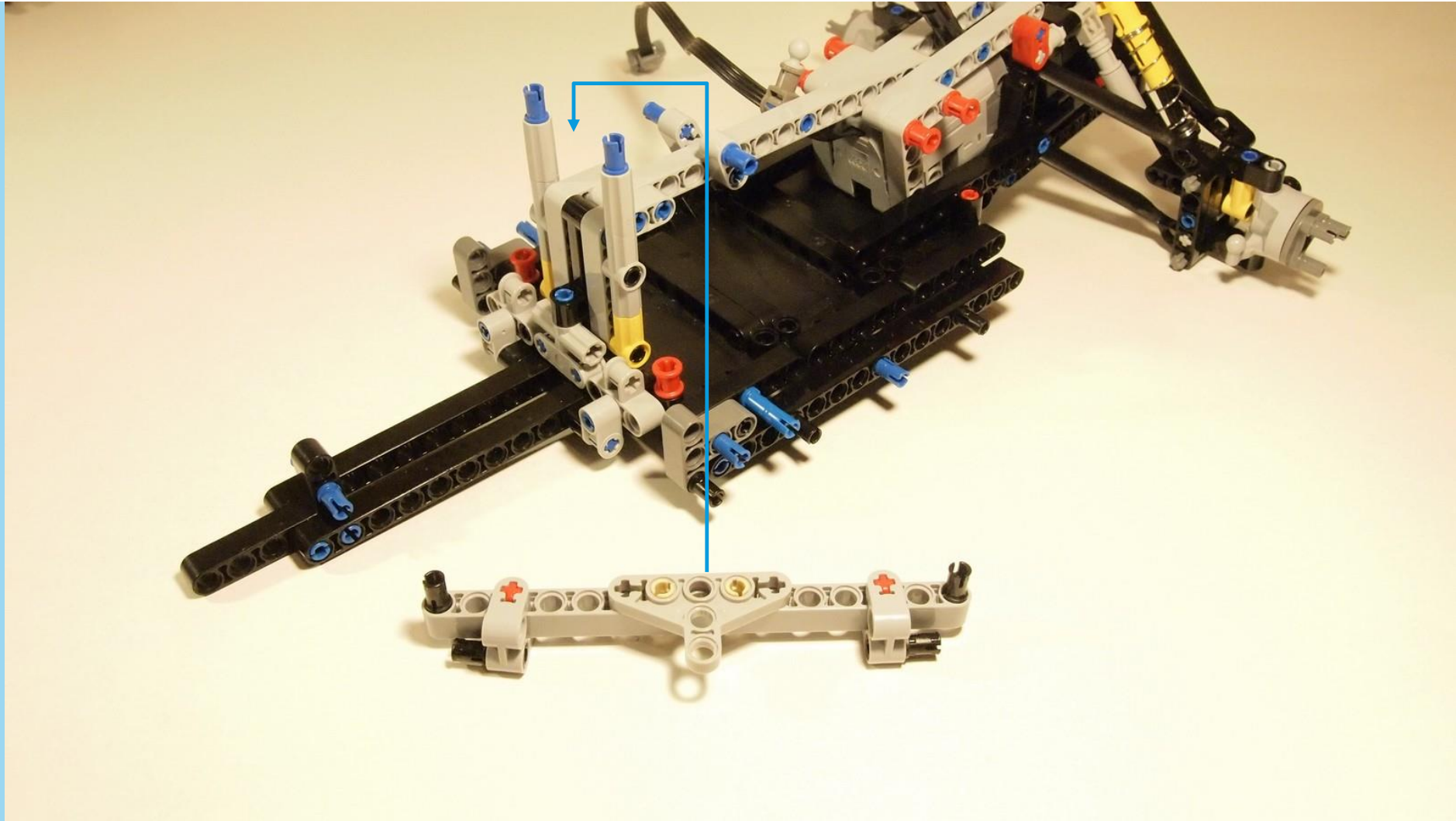

9

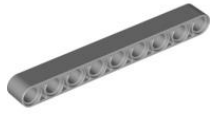

2x

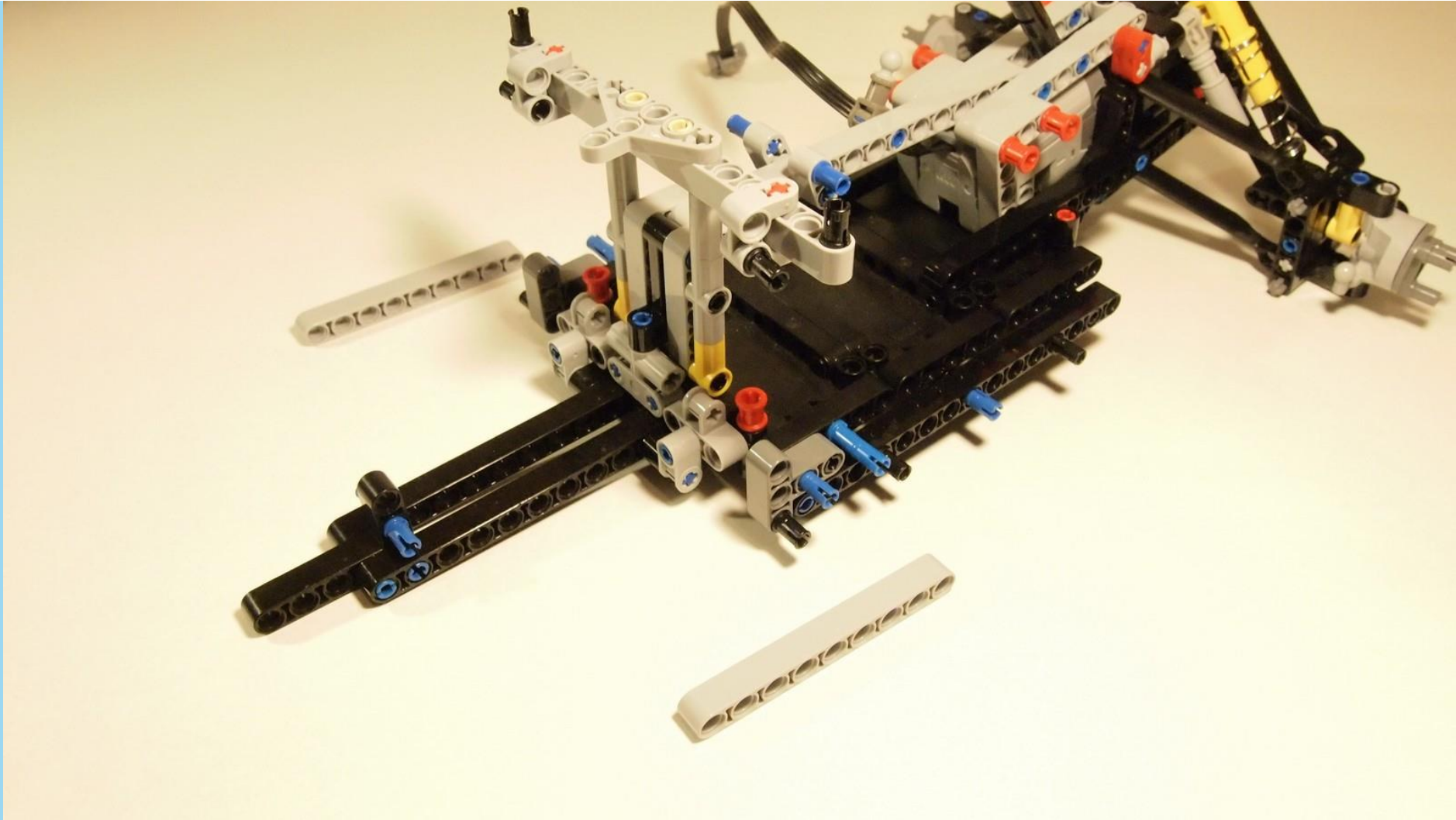

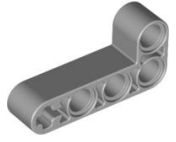

2x

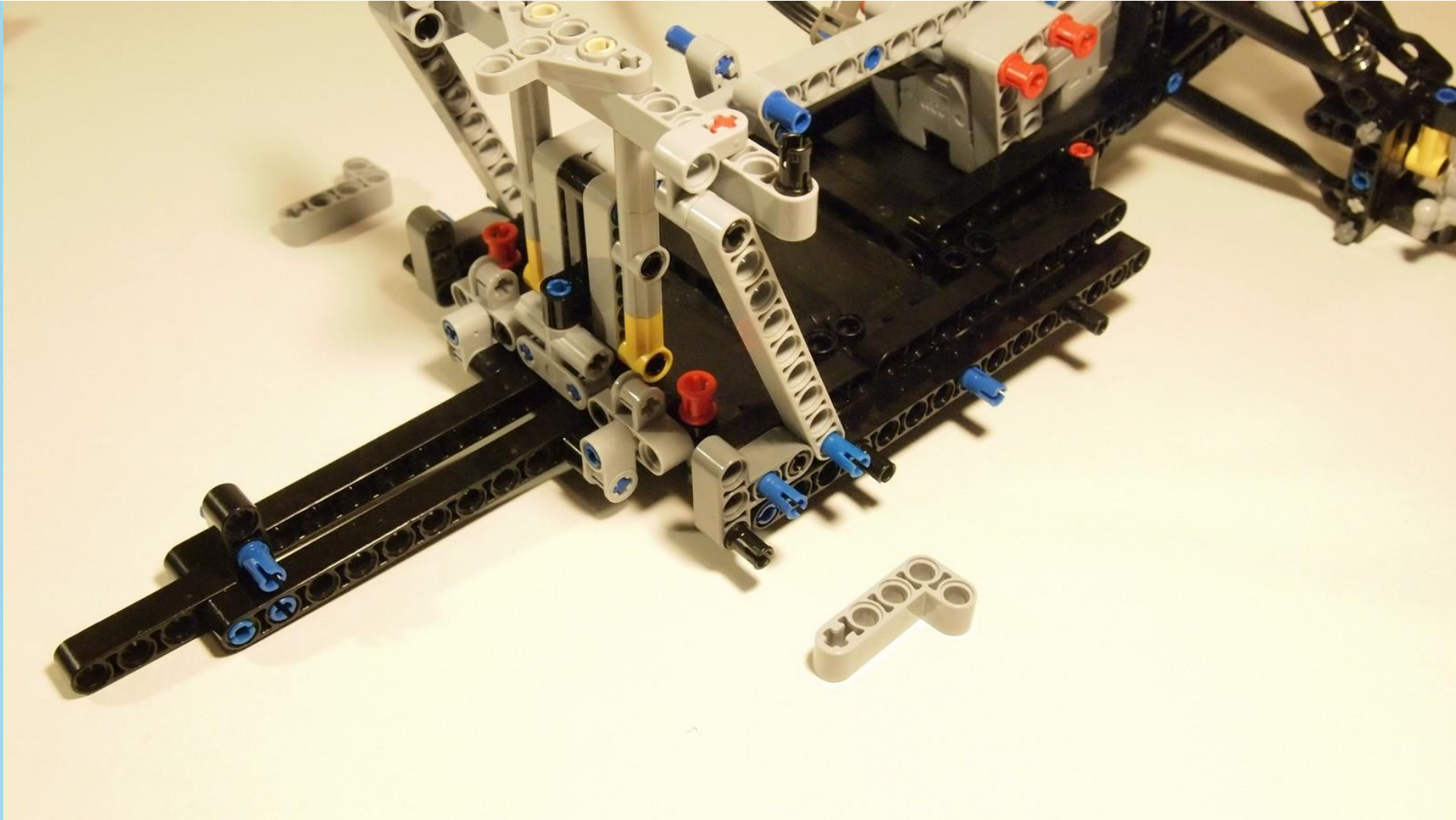

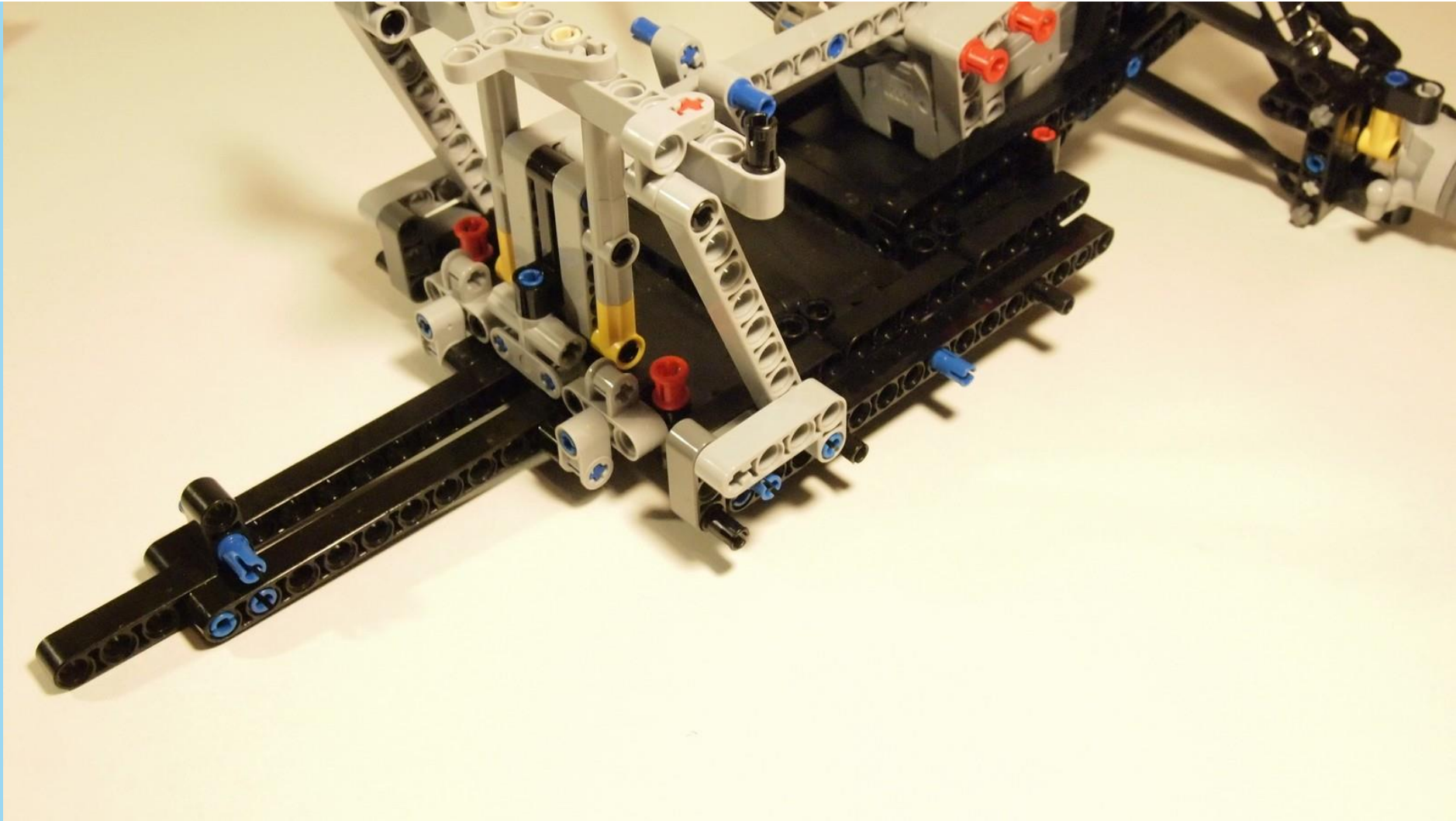



I will show you how to build the **left** side, build mirrored the **right** side!

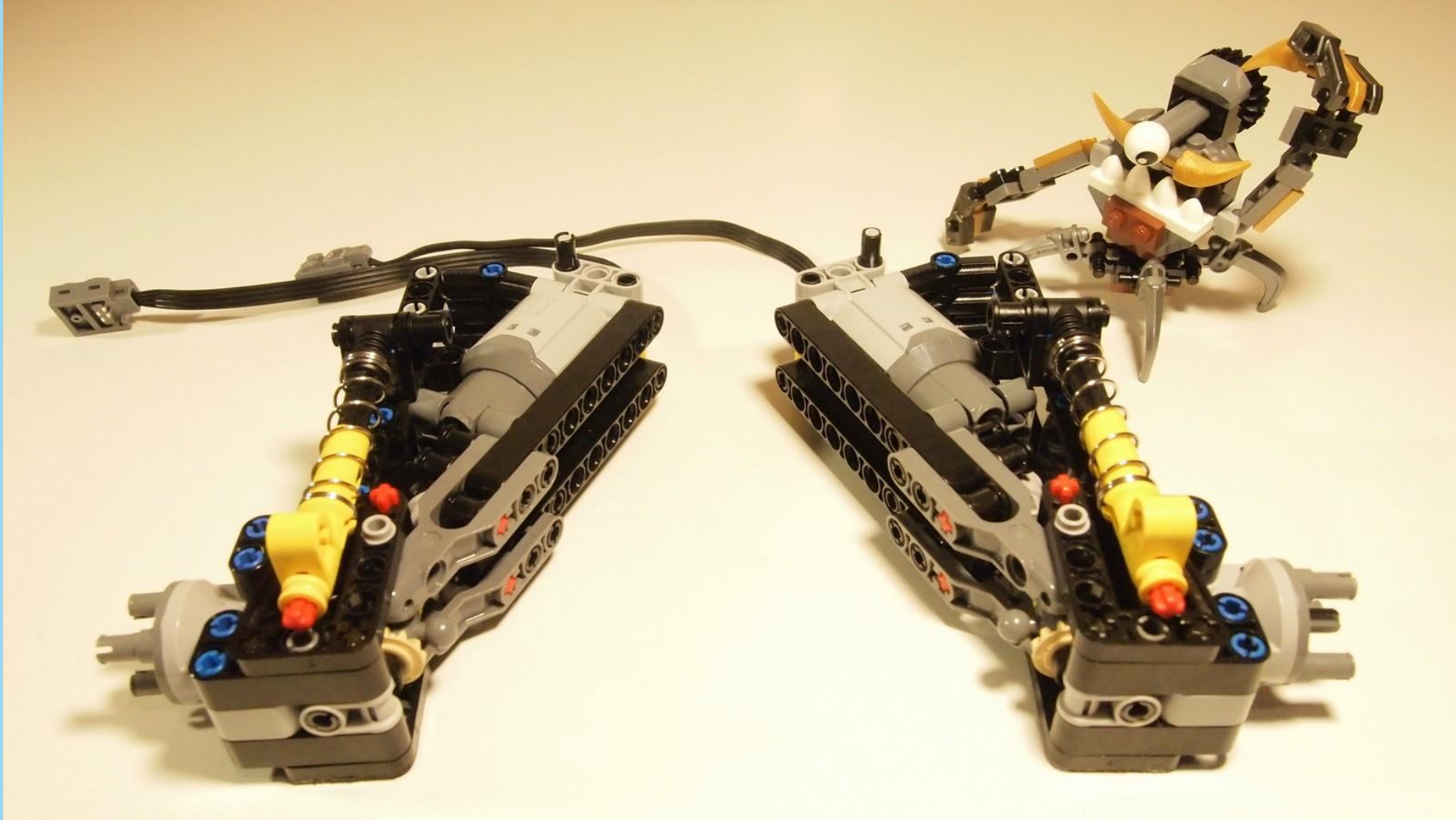



Modification by Madoca
RECOMMENDED!





Modification by Madoca
RECOMMENDED!



5.5



1x



1x



1x





5.5



1x



1x



1x

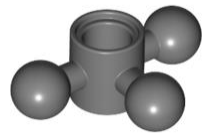

1x



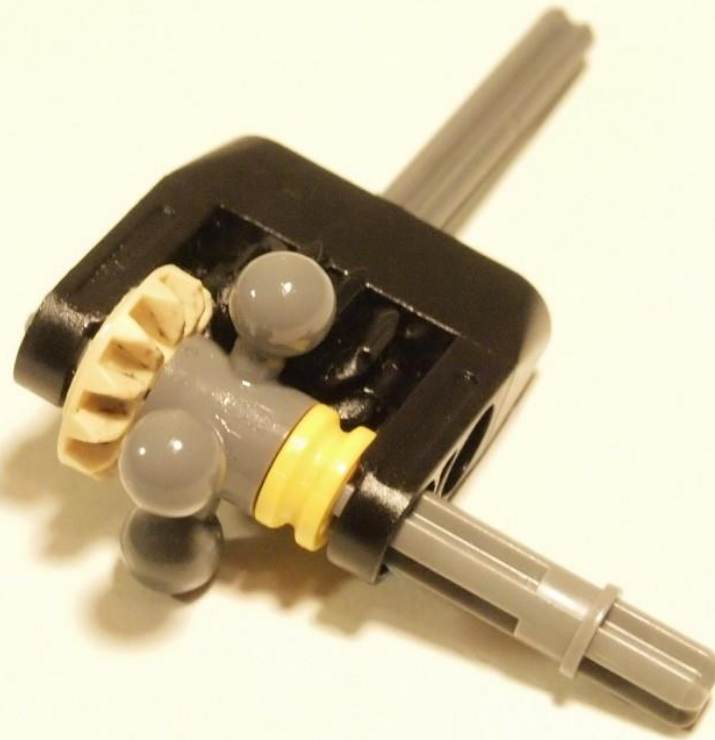



1x



1x

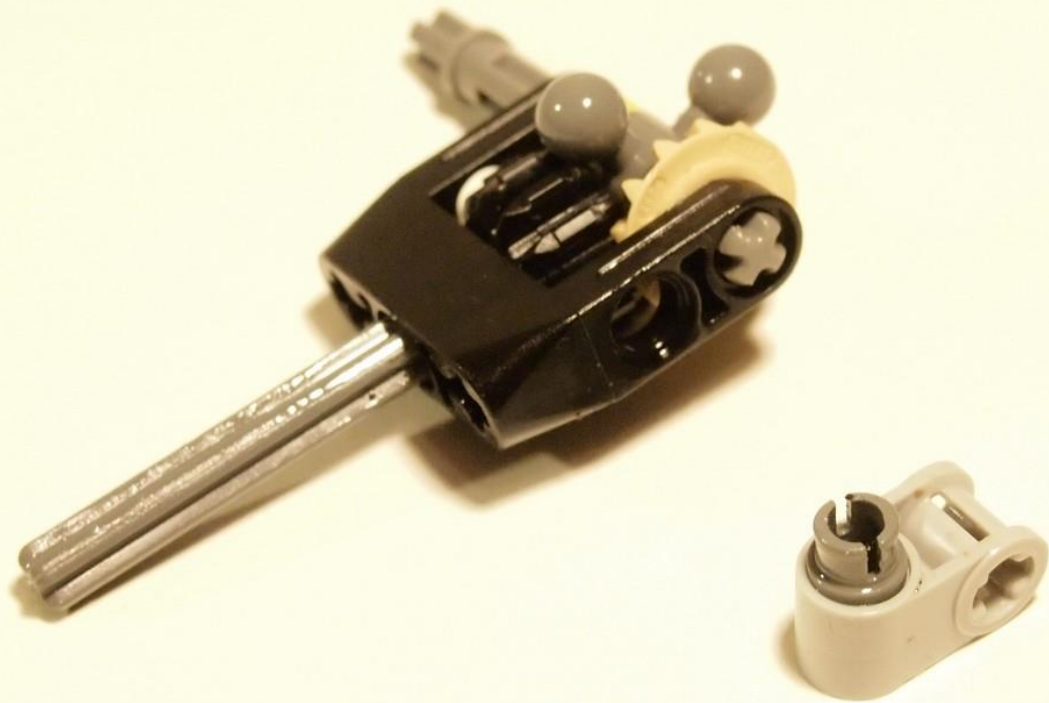



1x



1x



2x

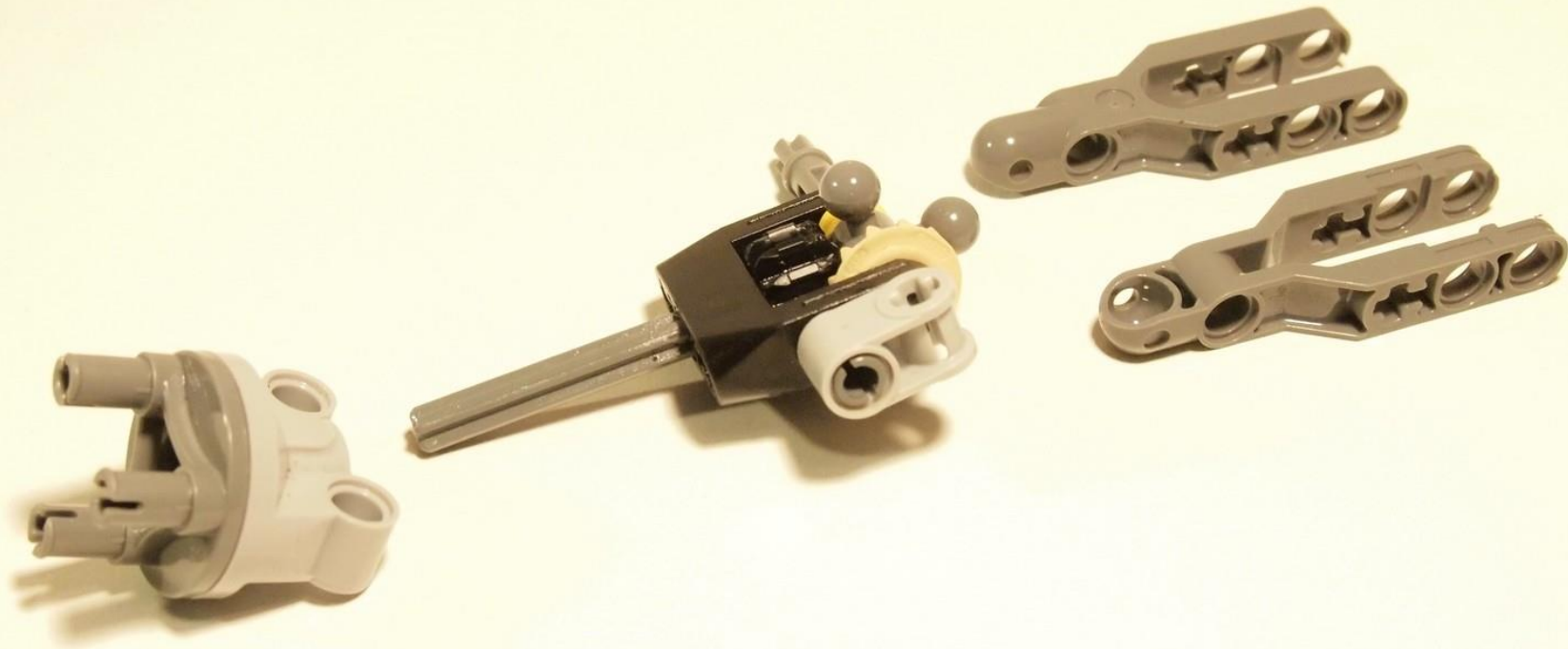





1x



1x



2x



1x



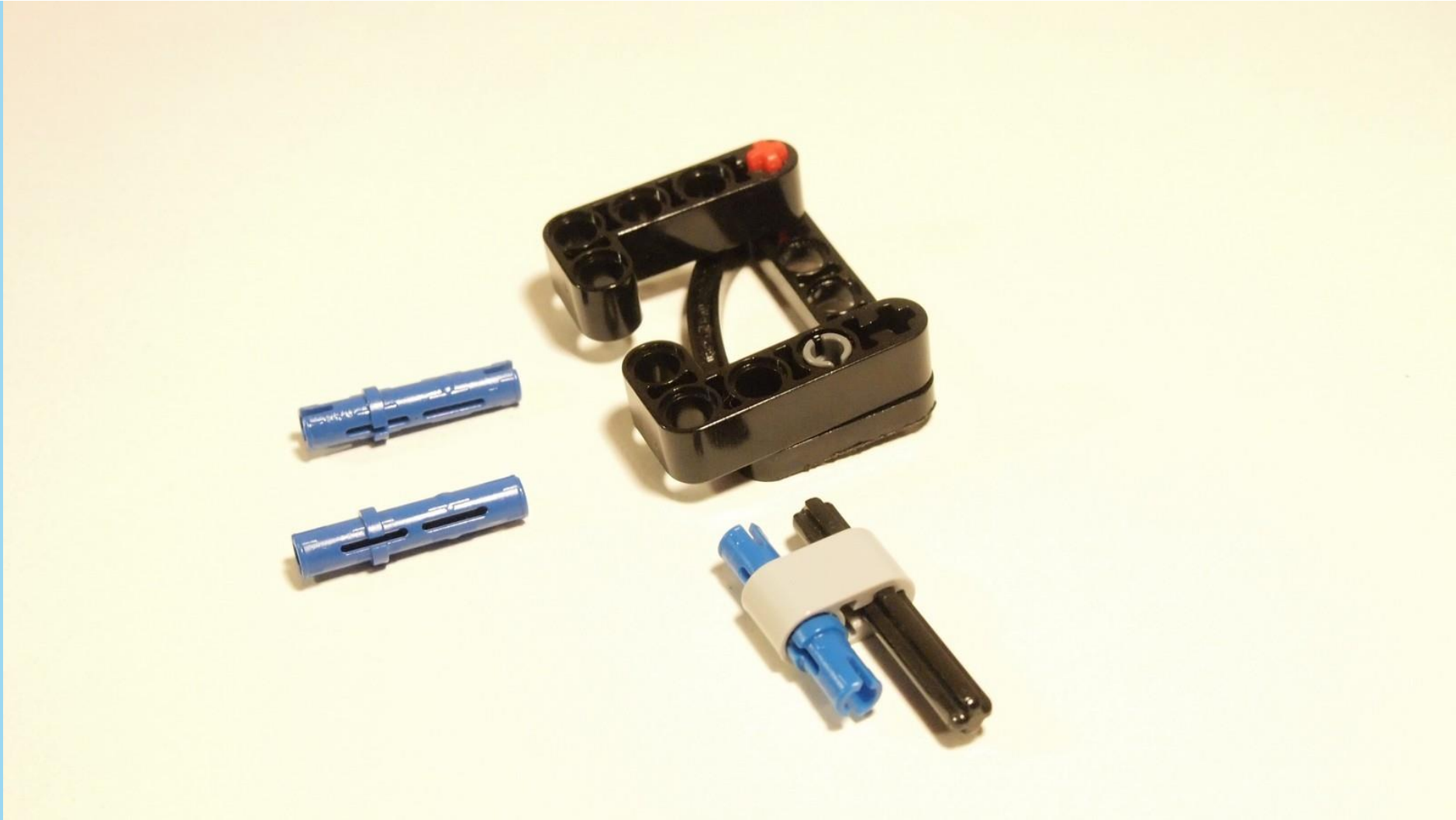
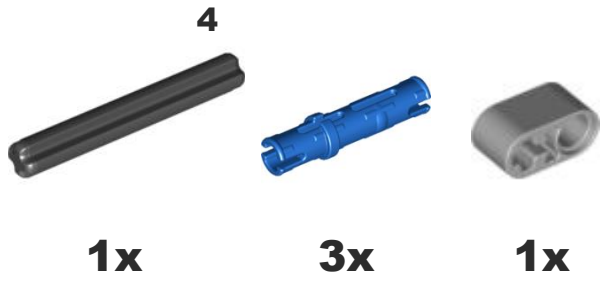



4



1x

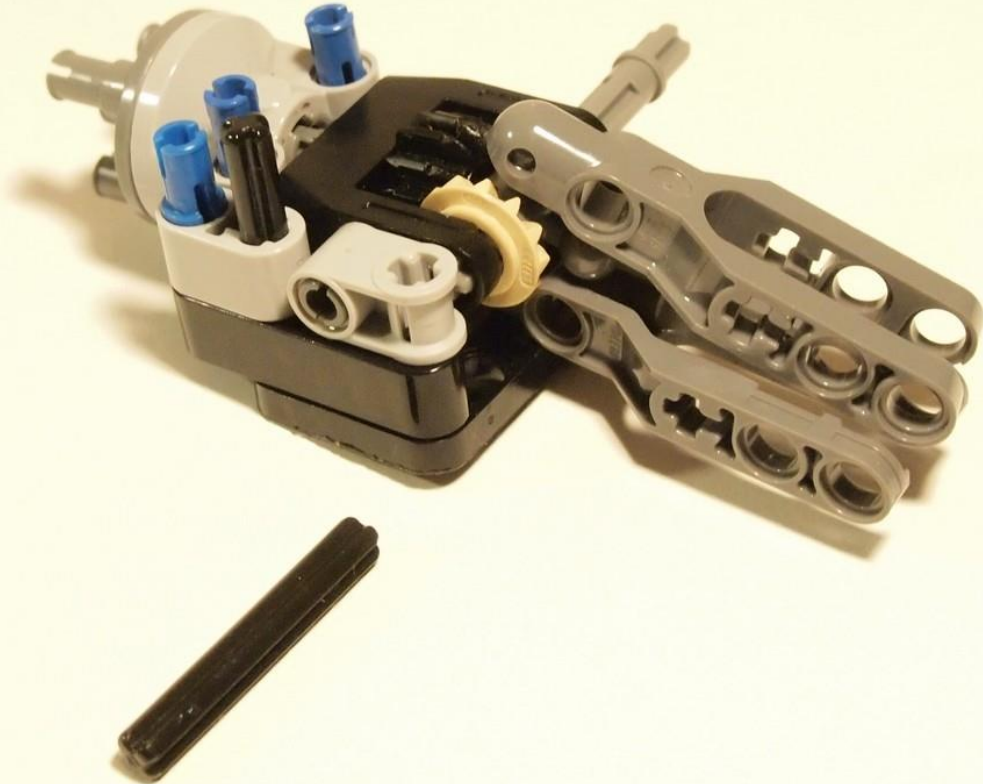

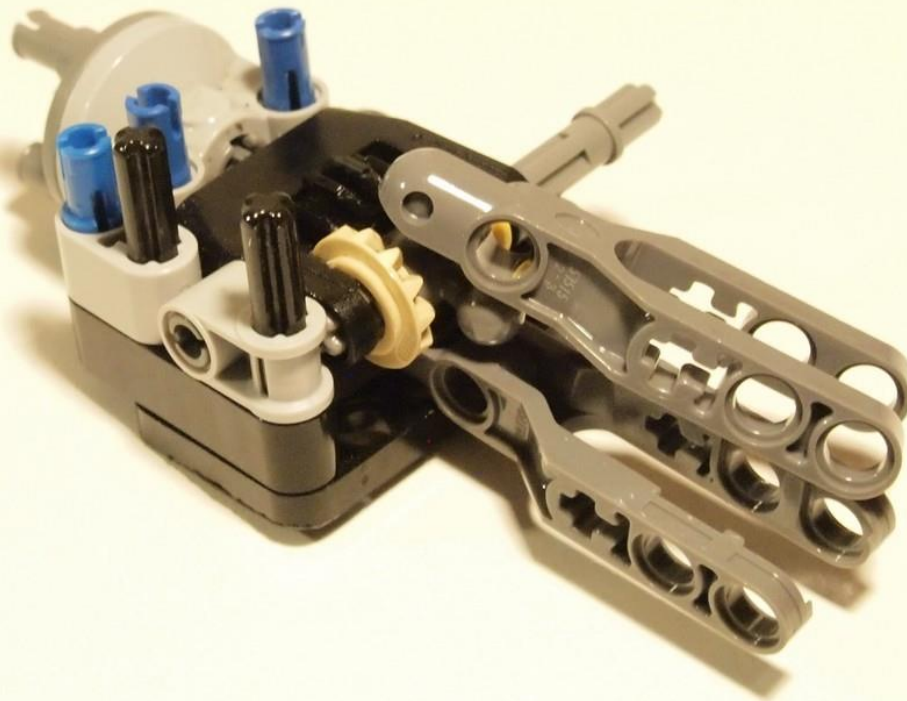



1x



3x

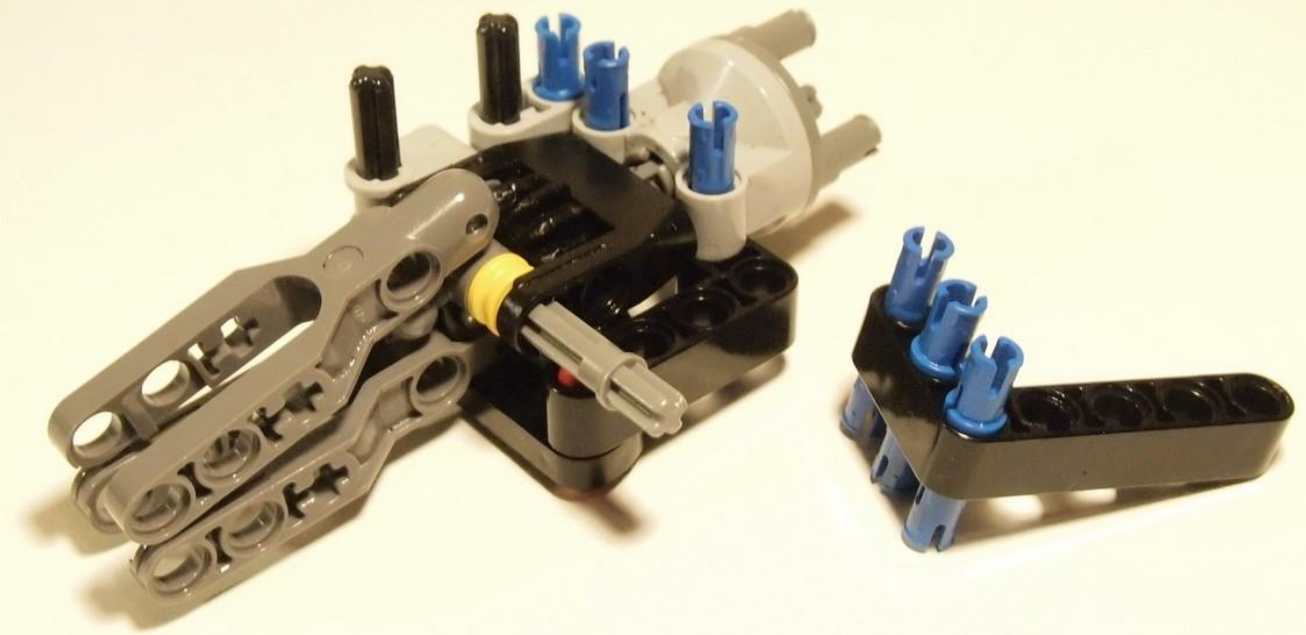



2x

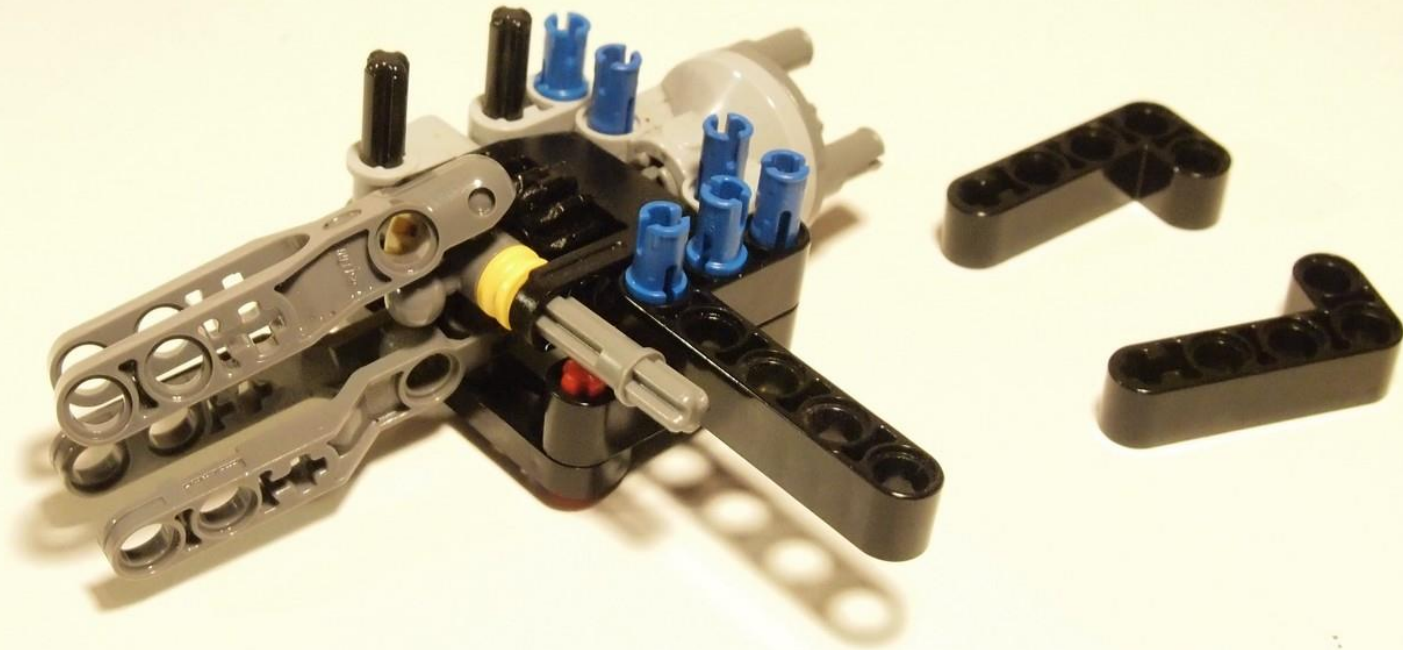

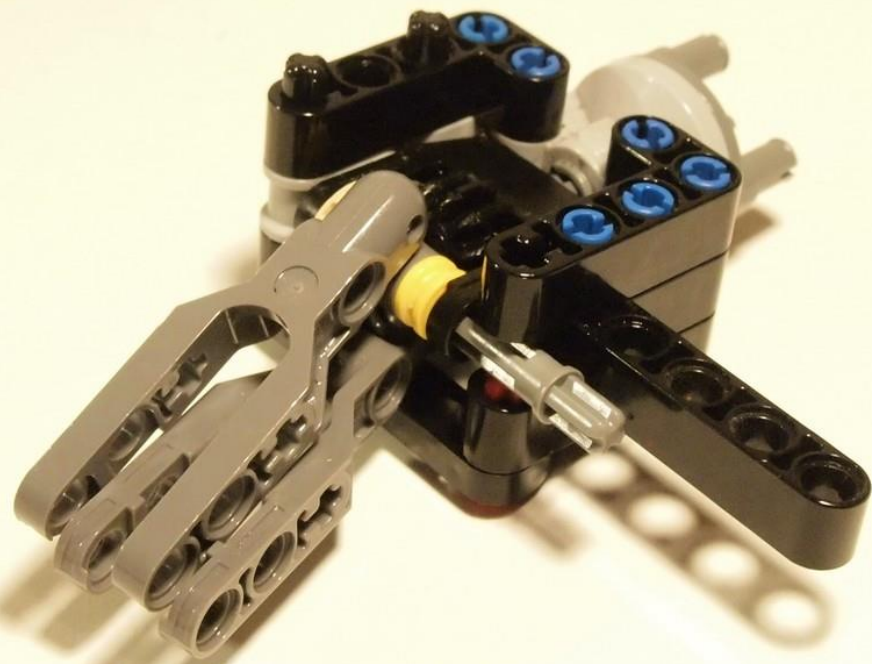



1x



1x

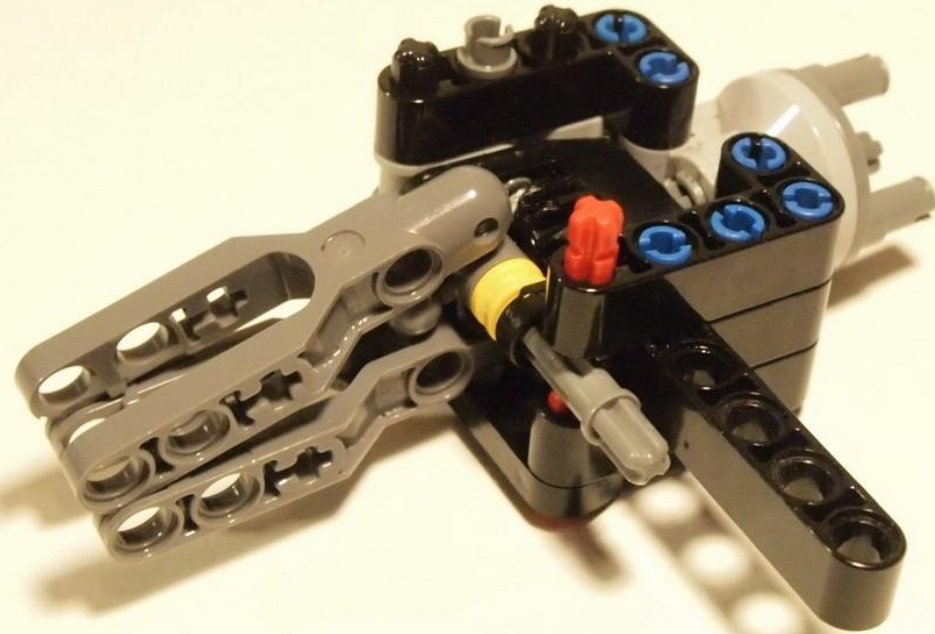



1x



1x

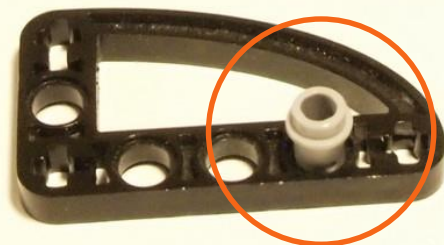
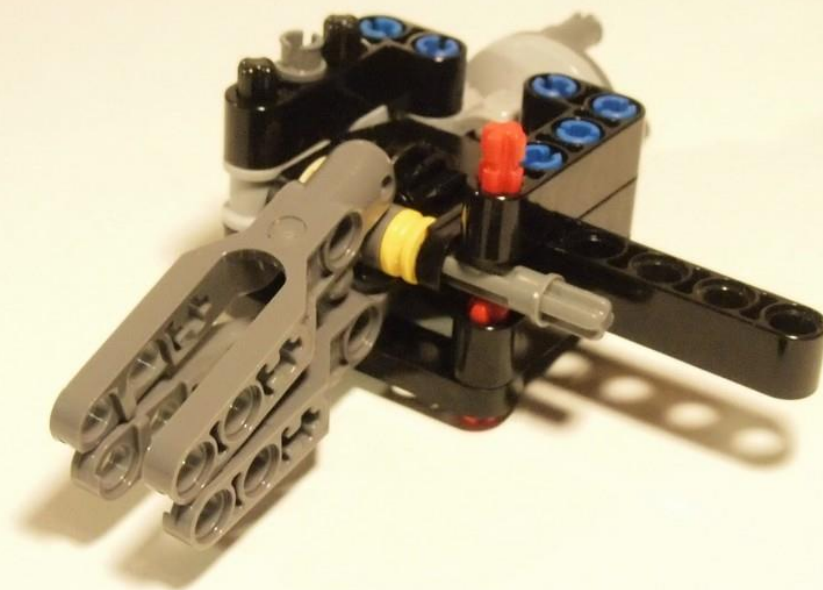

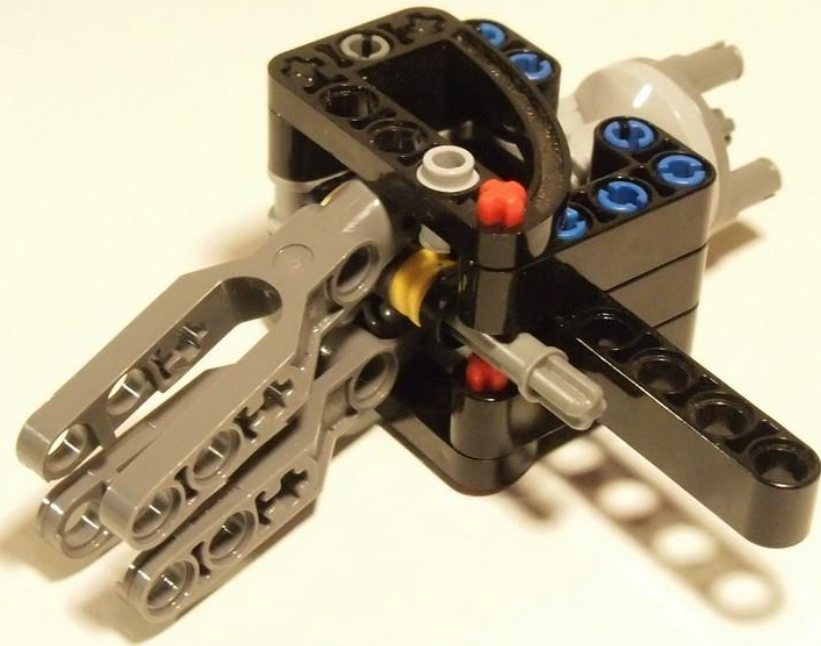



Equal spacing, smooth rotation!

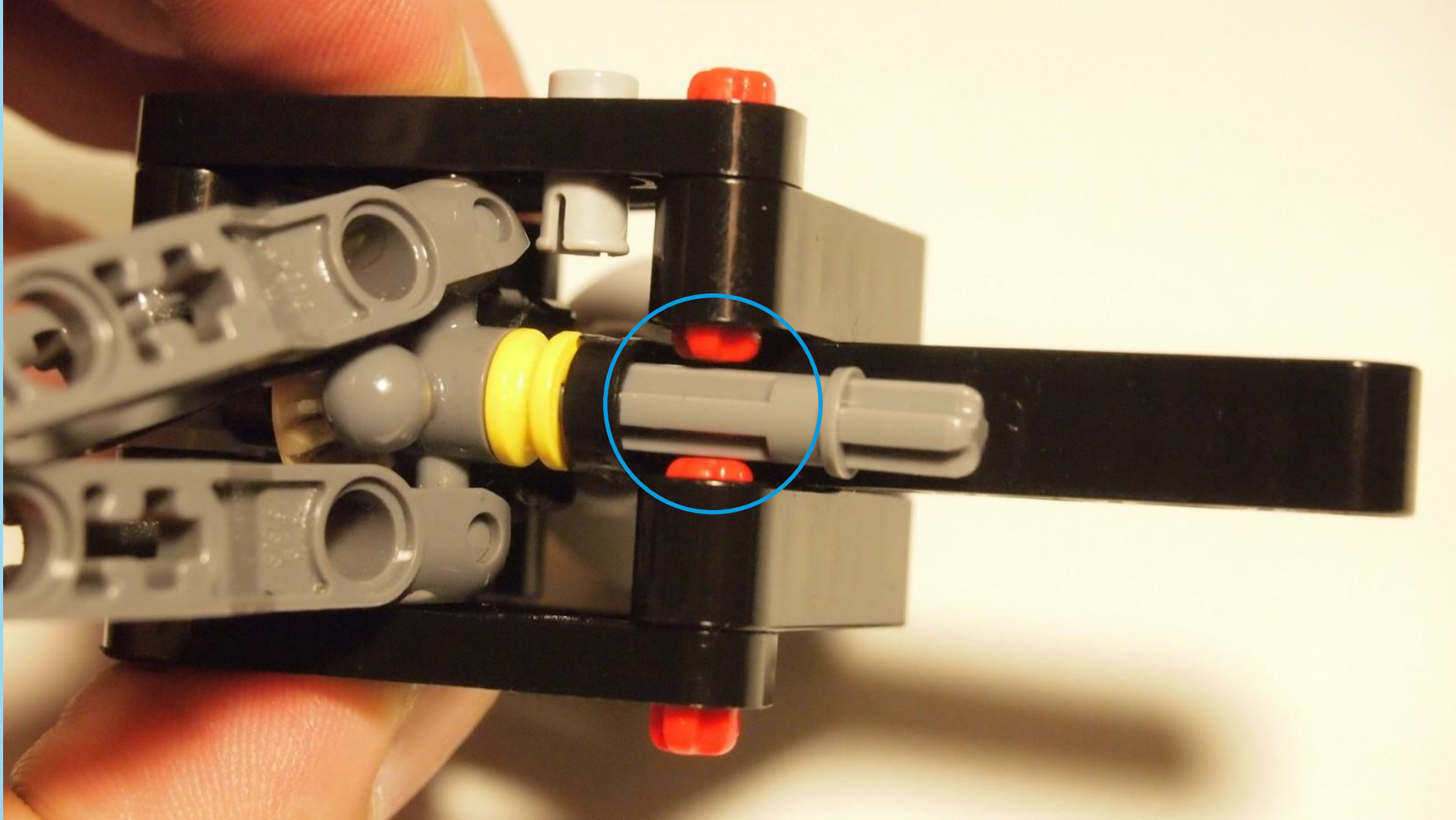

11



1x



1x



3x

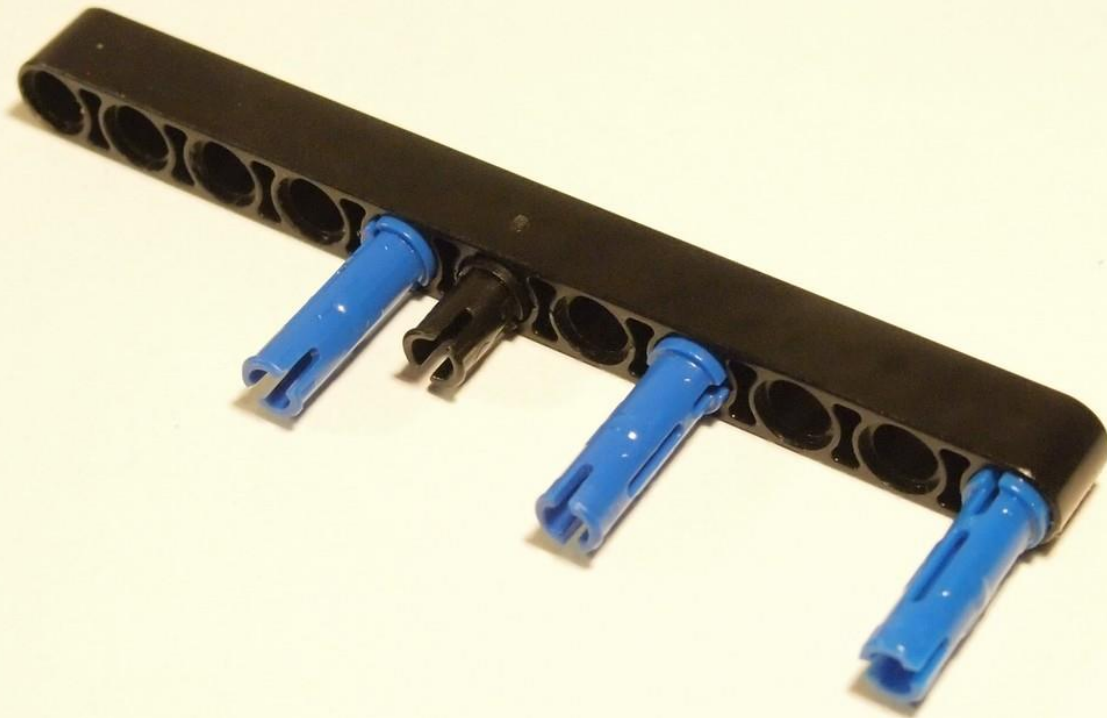



1x



1x



1x

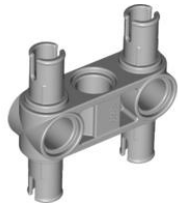

1x

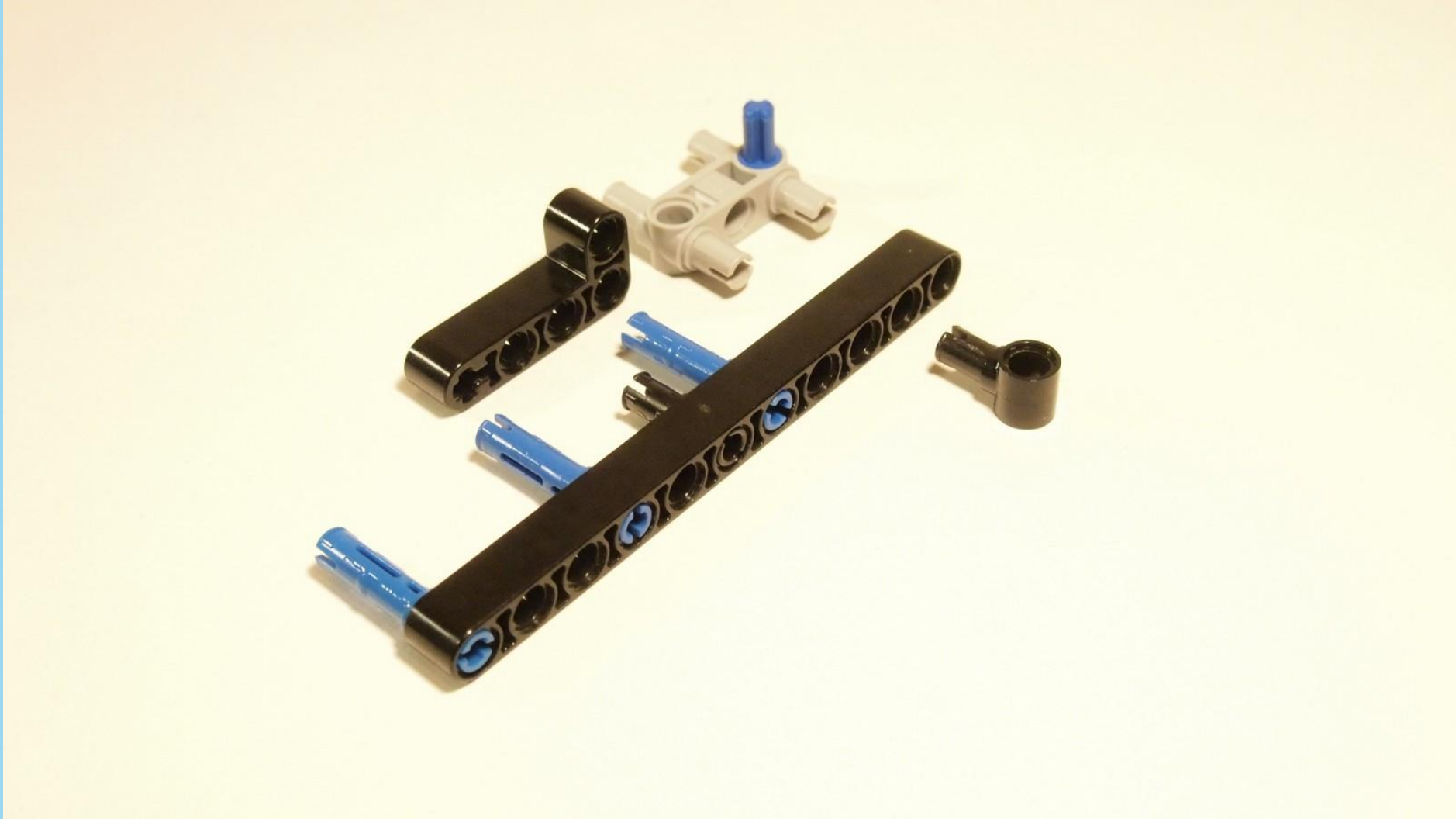

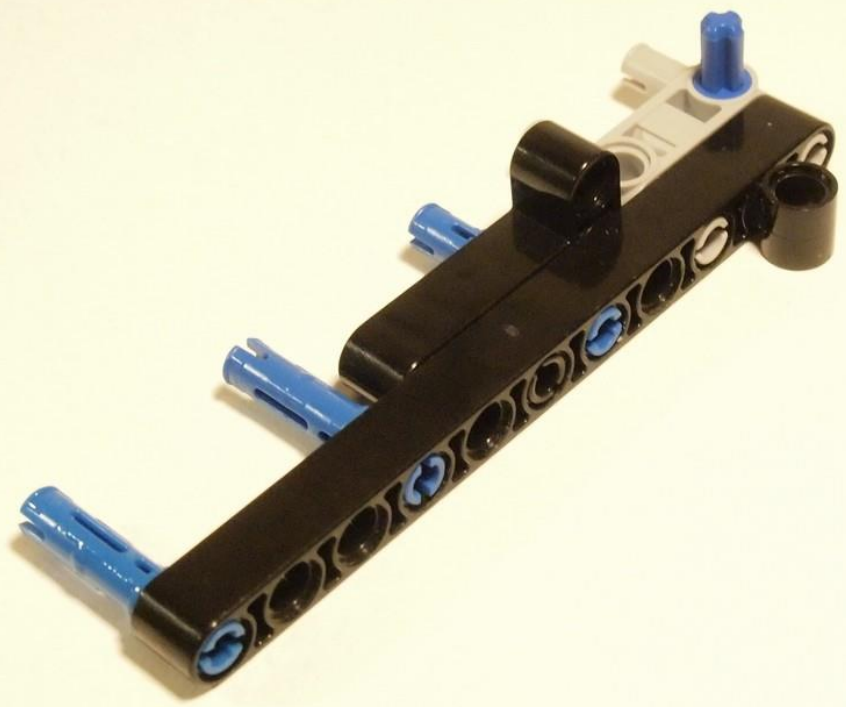

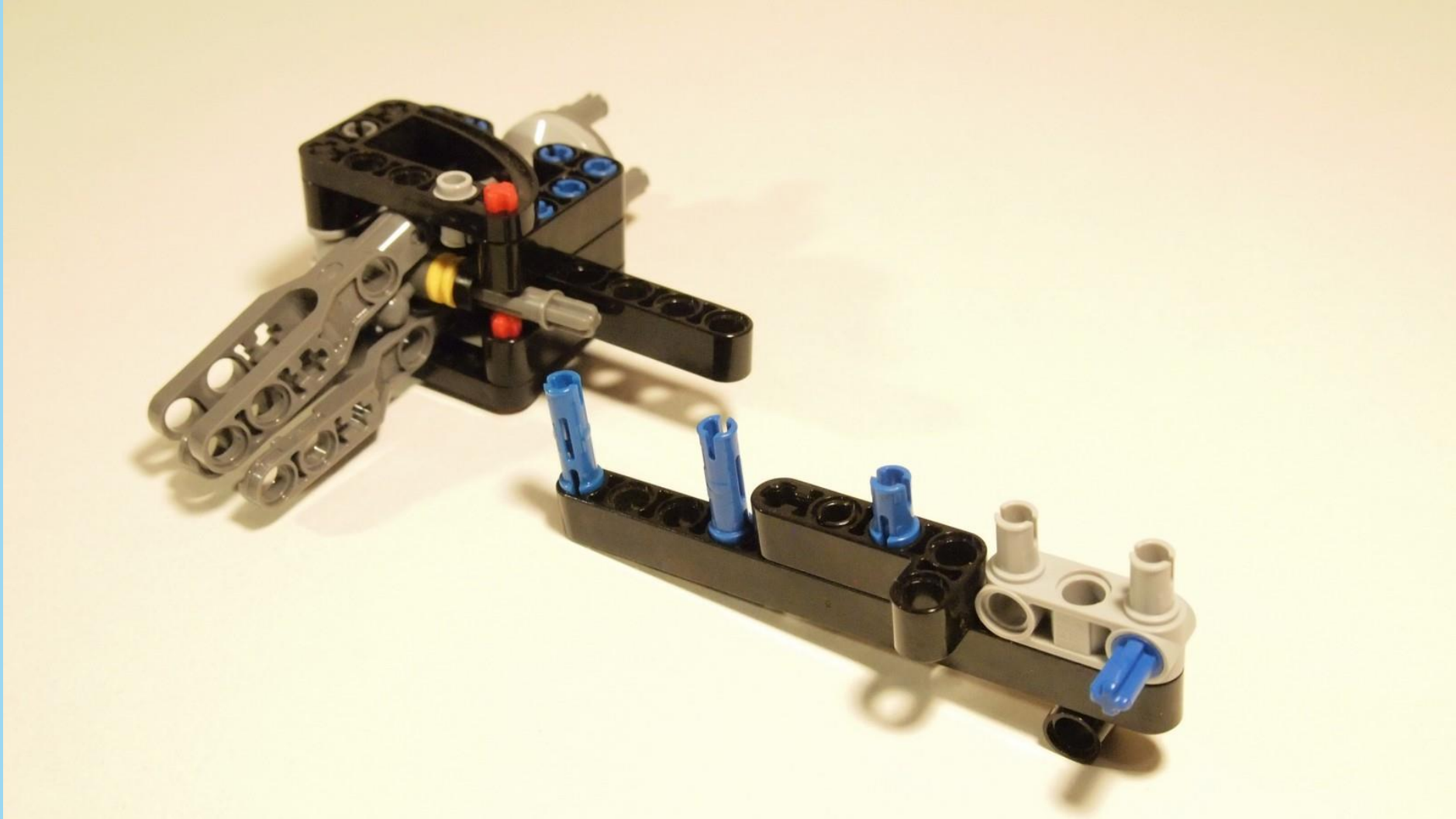

11



1x

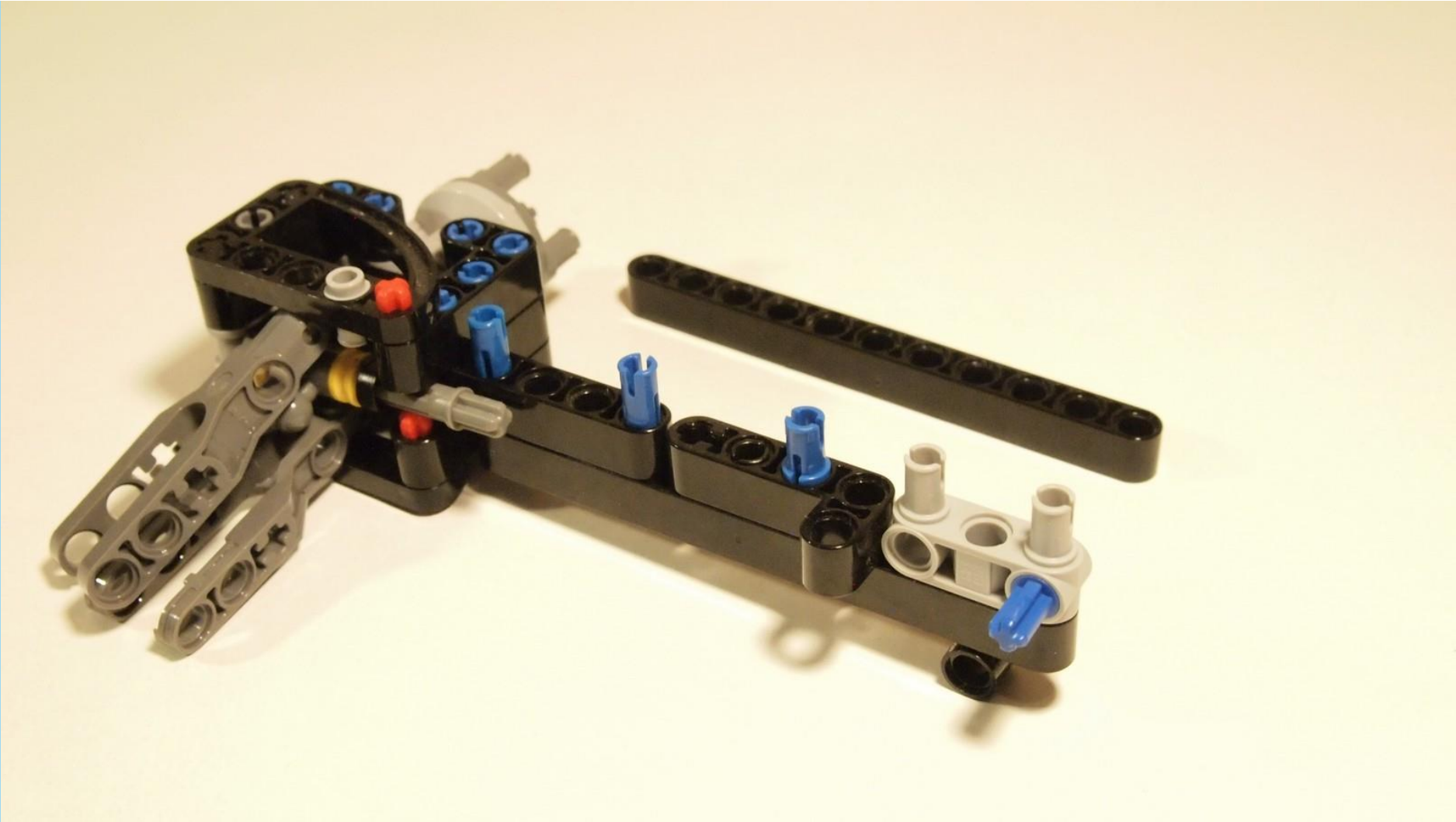



2x



1x

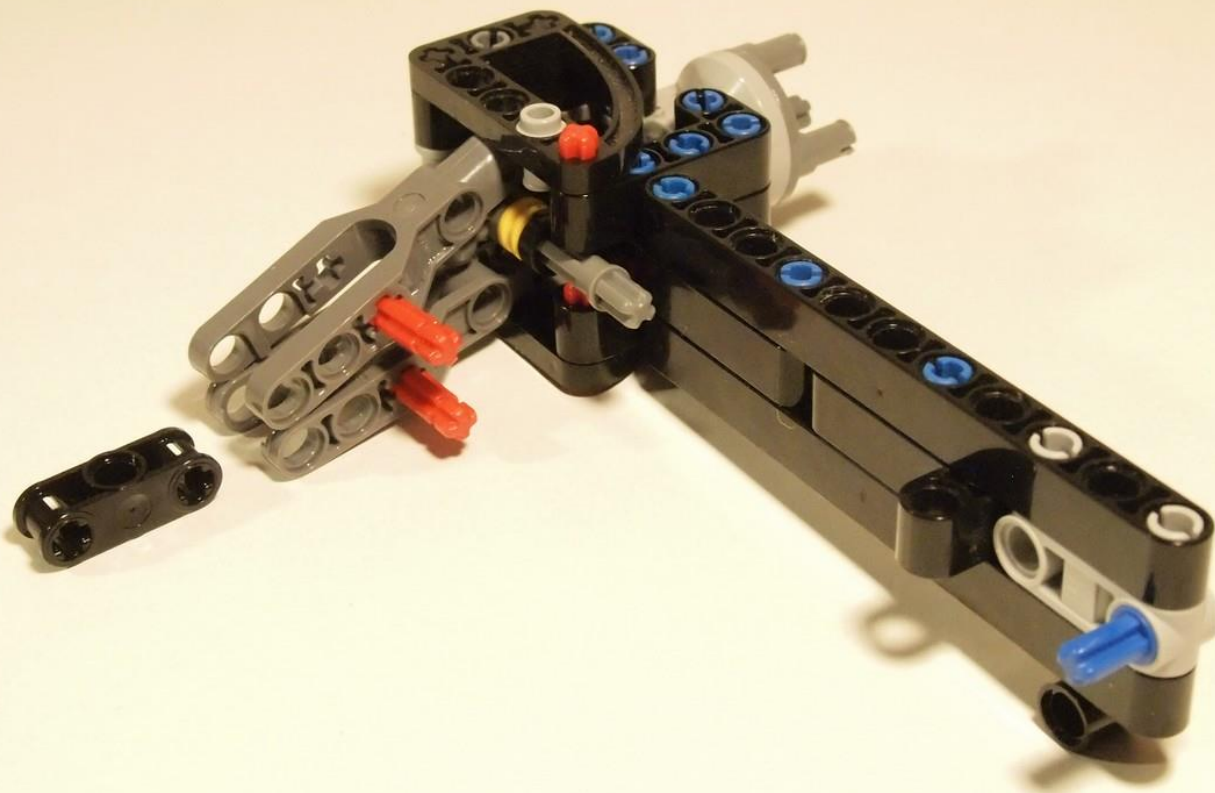

9



2x



4x

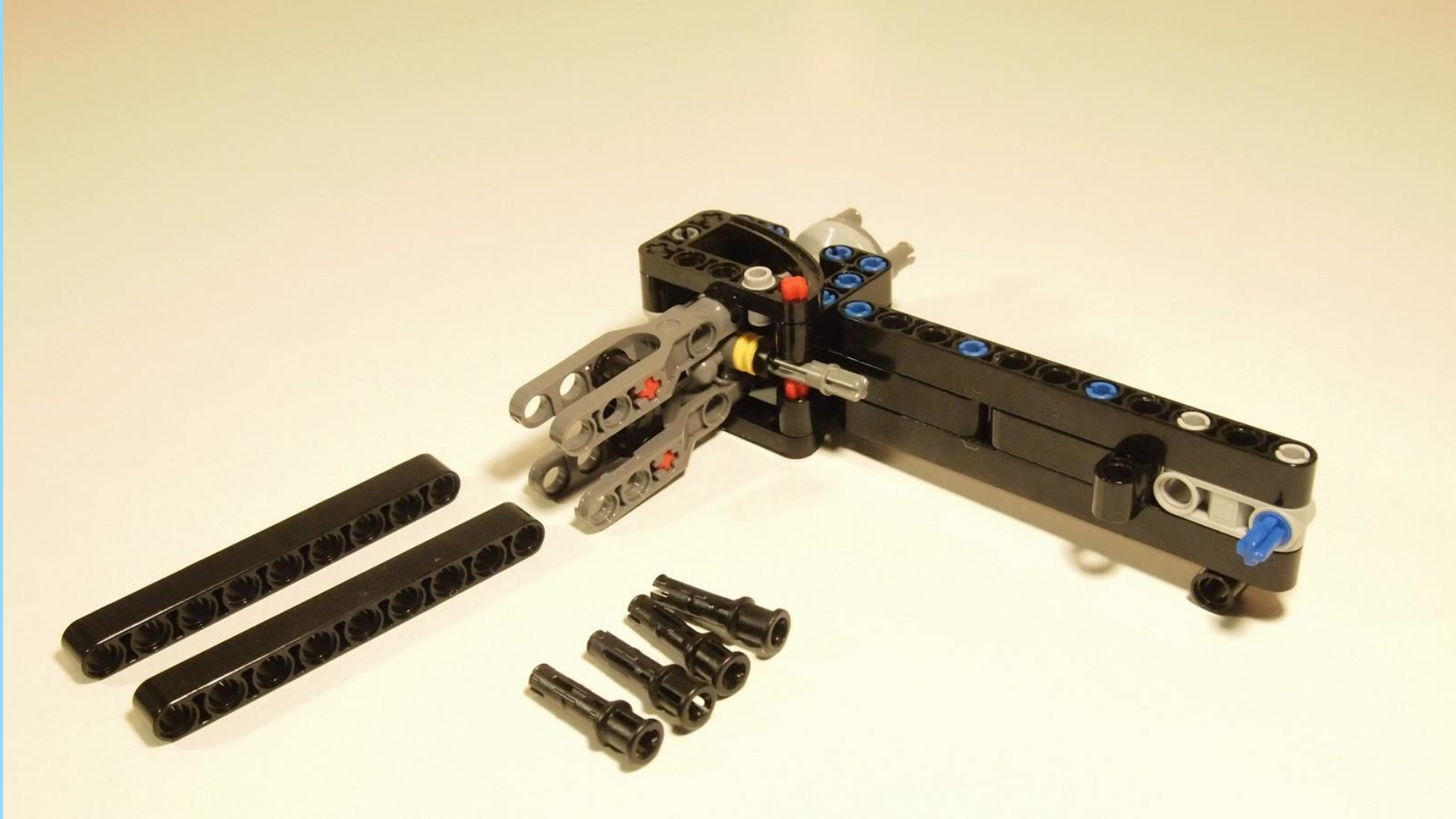

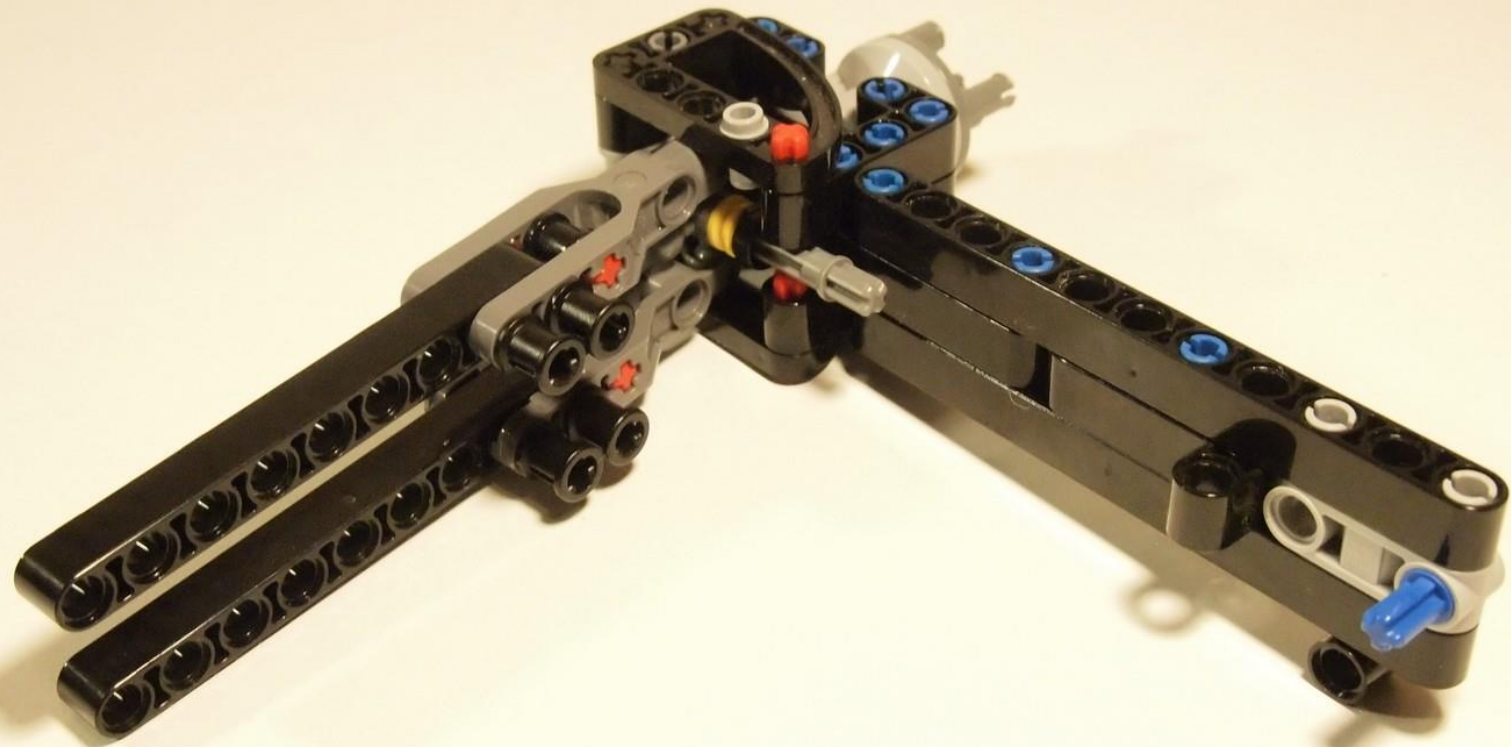



1x



2x

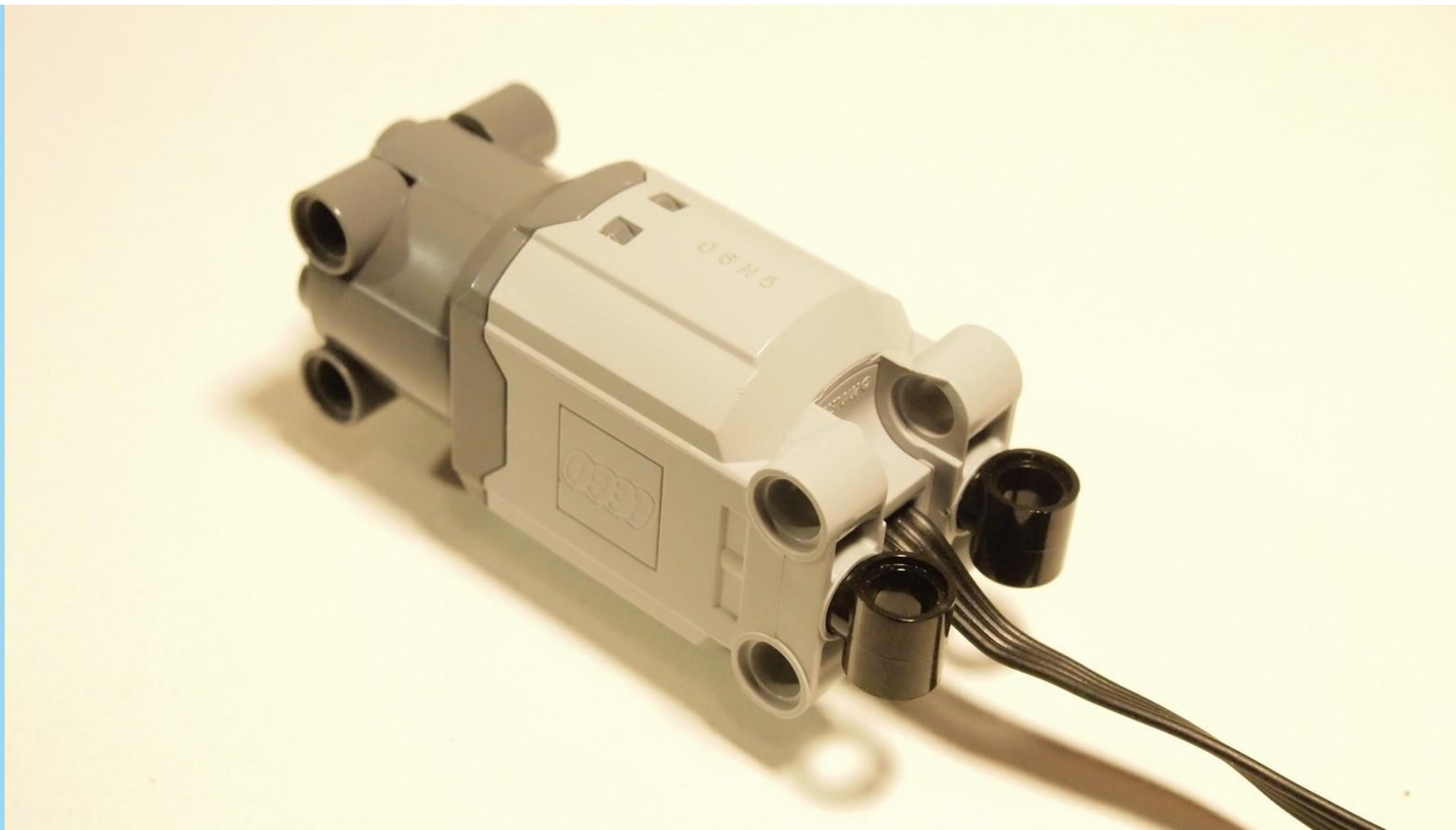



1x



1x



1x

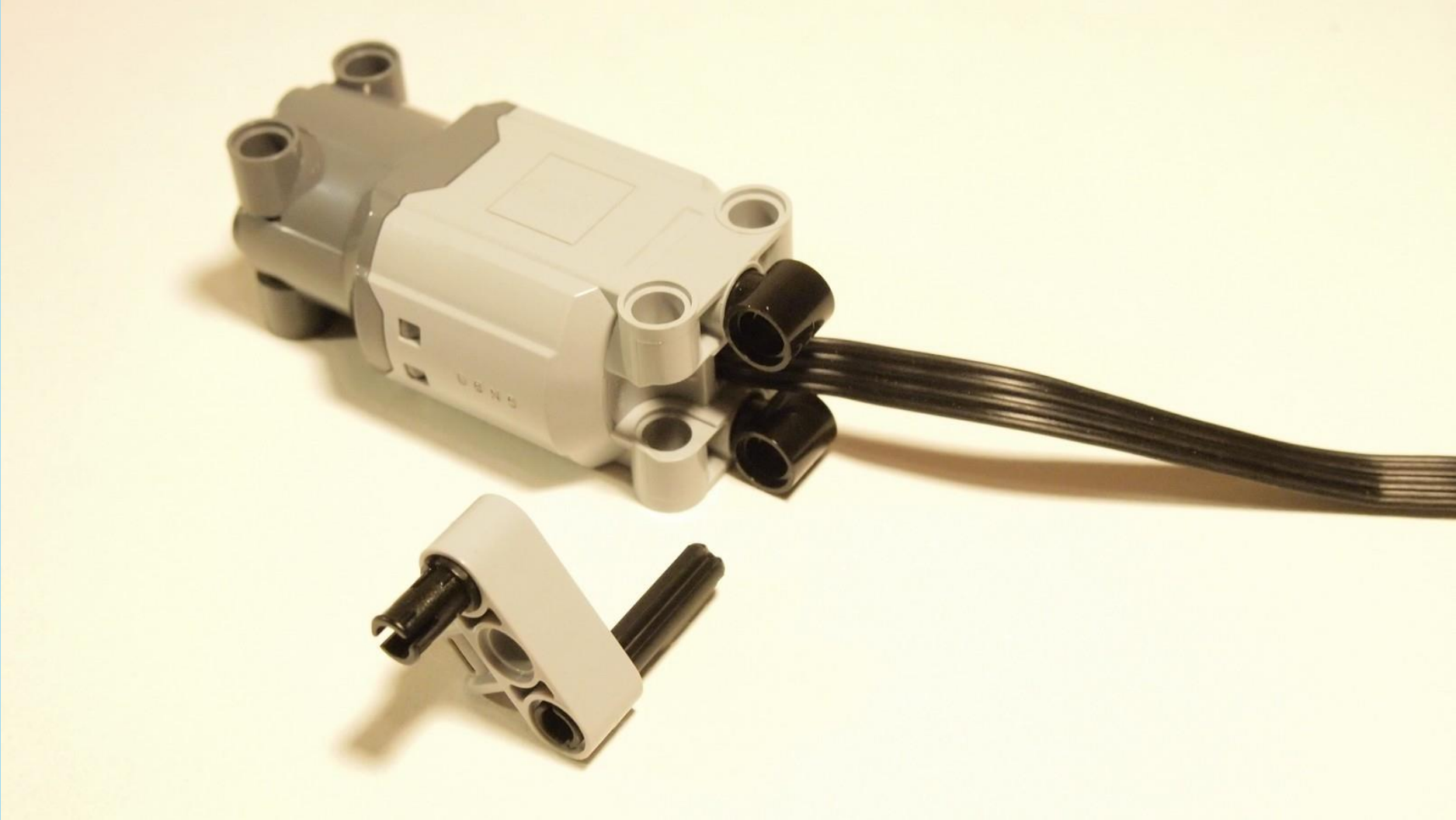



1x

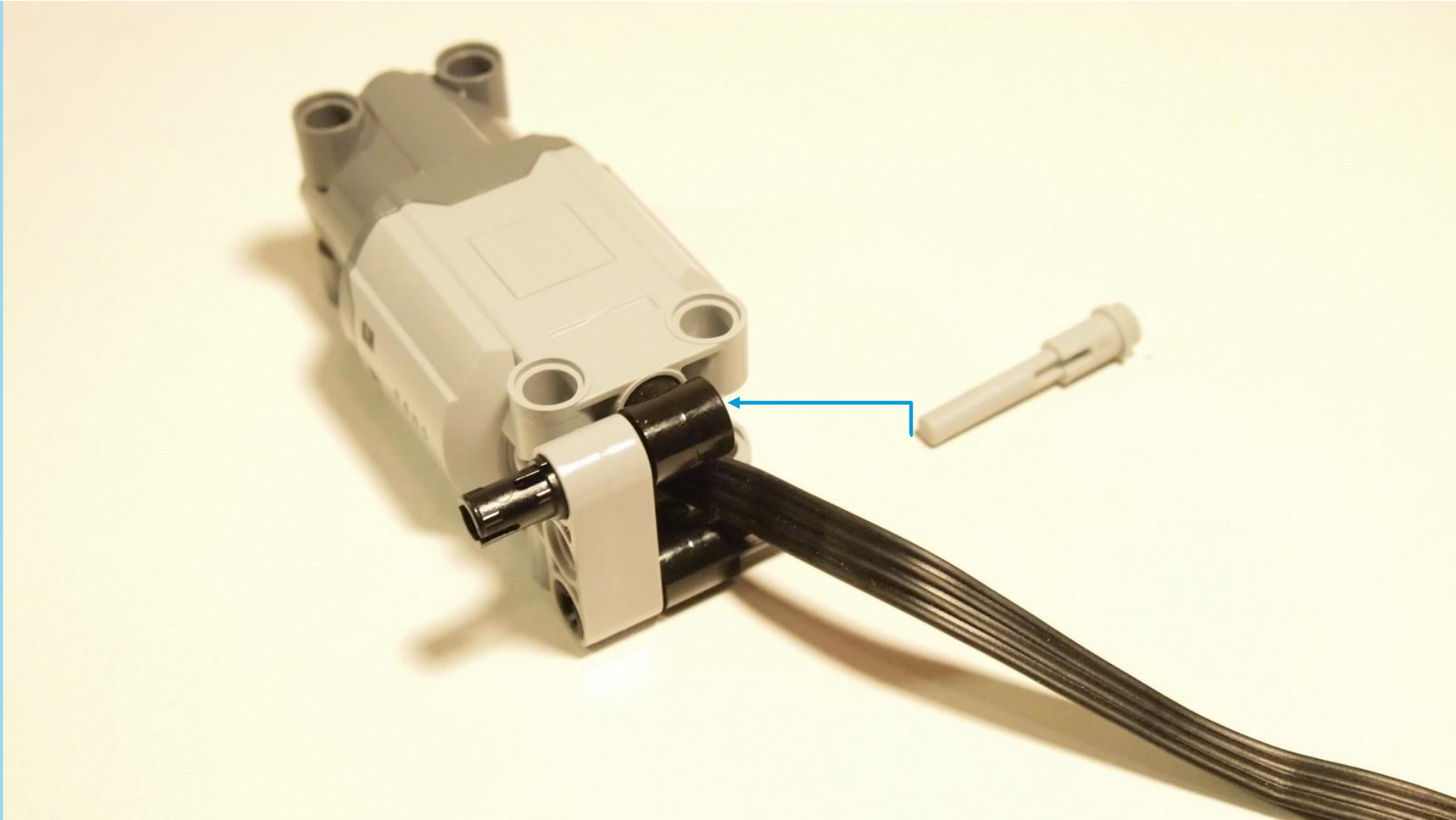



1x



1x

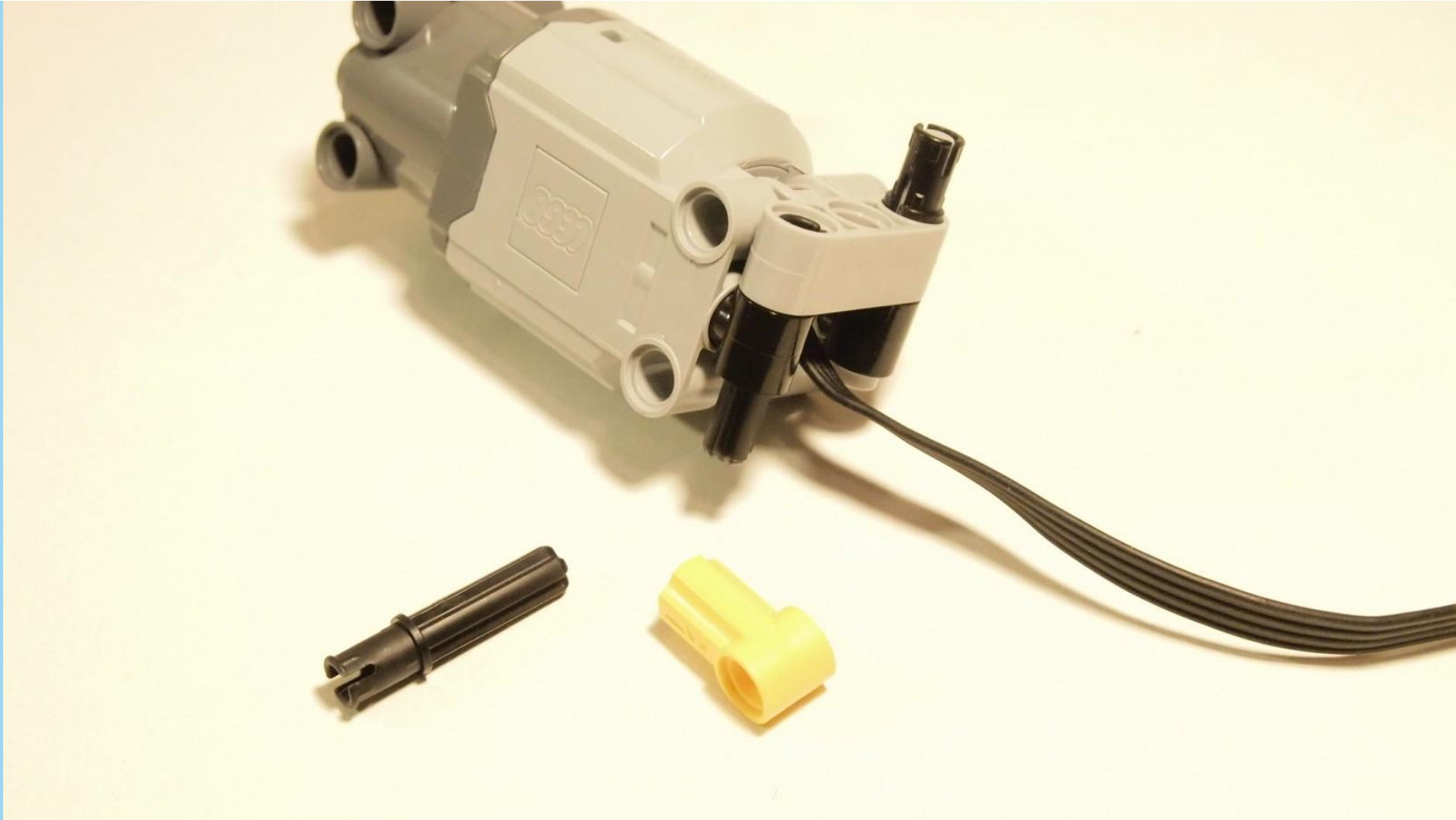

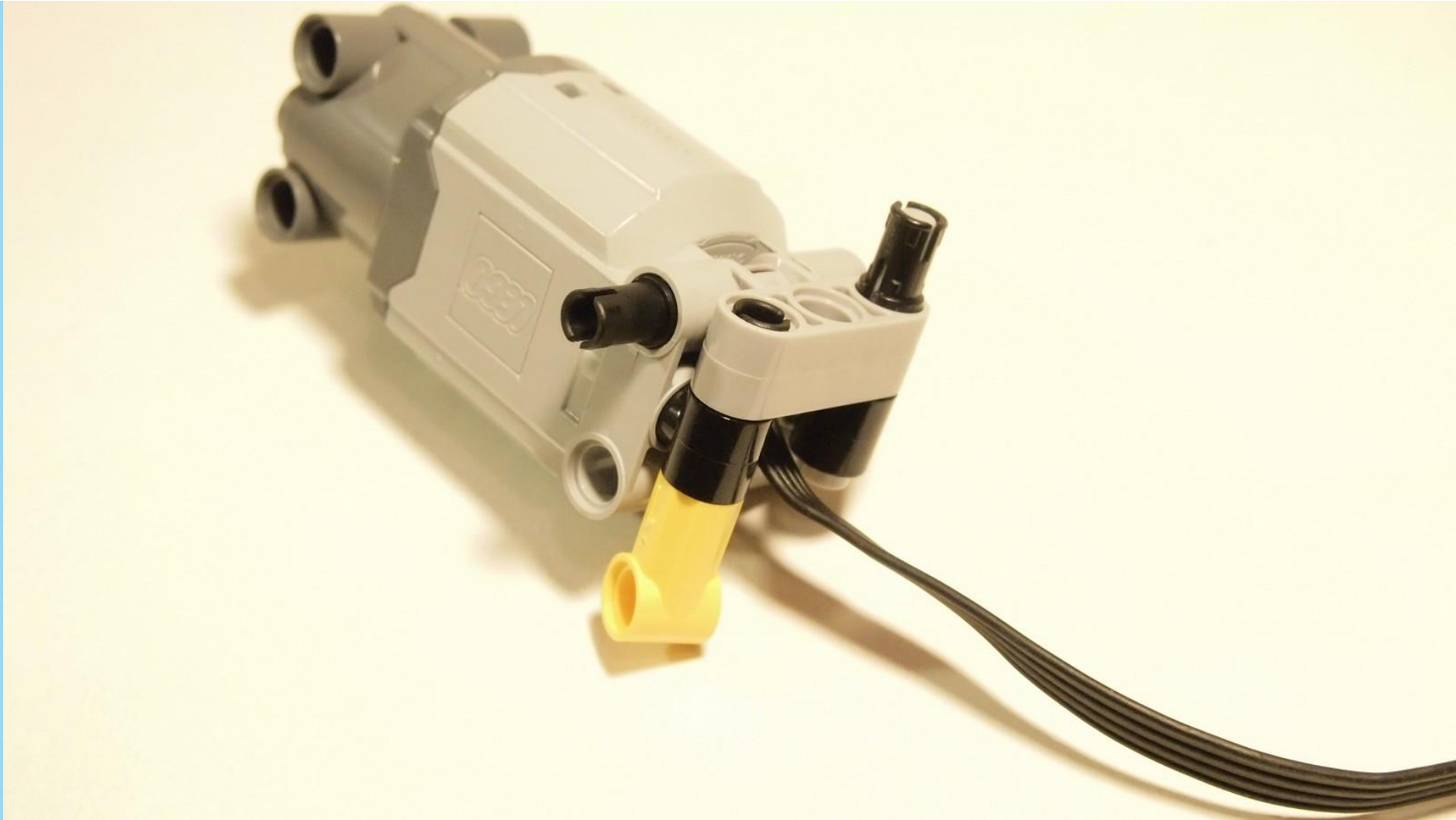



1x

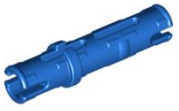

1x



3x

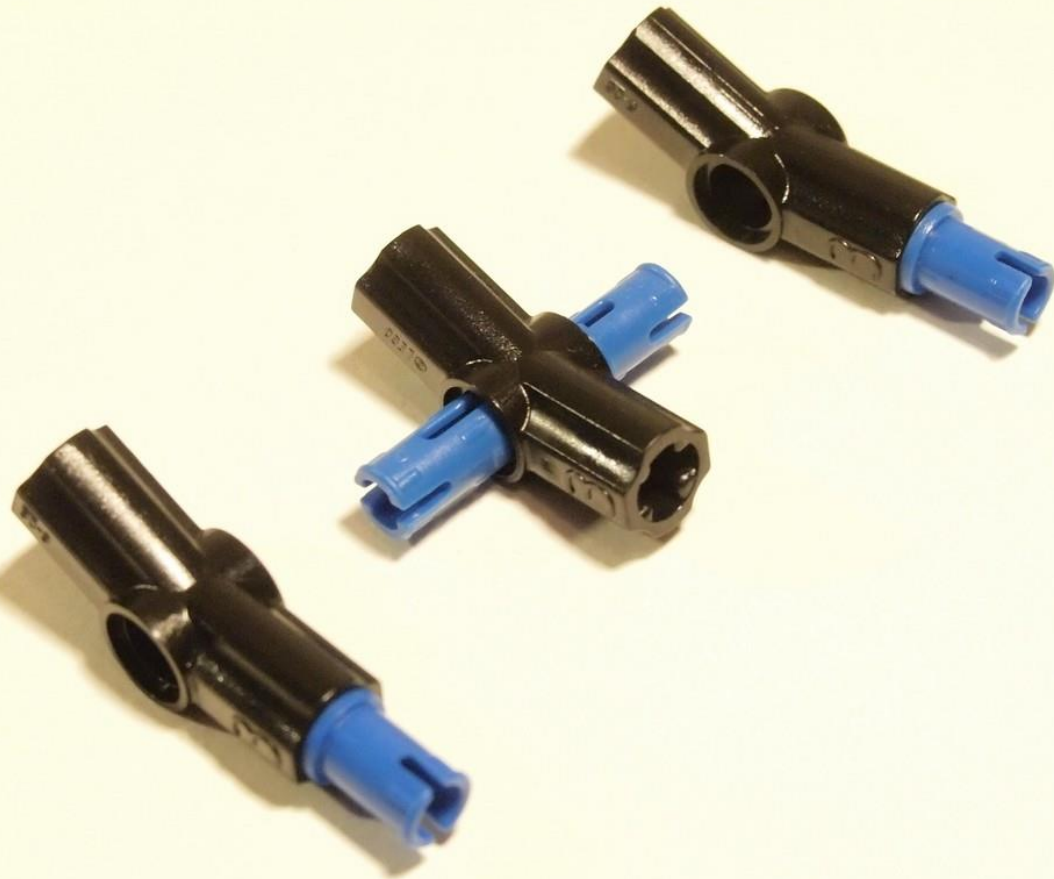

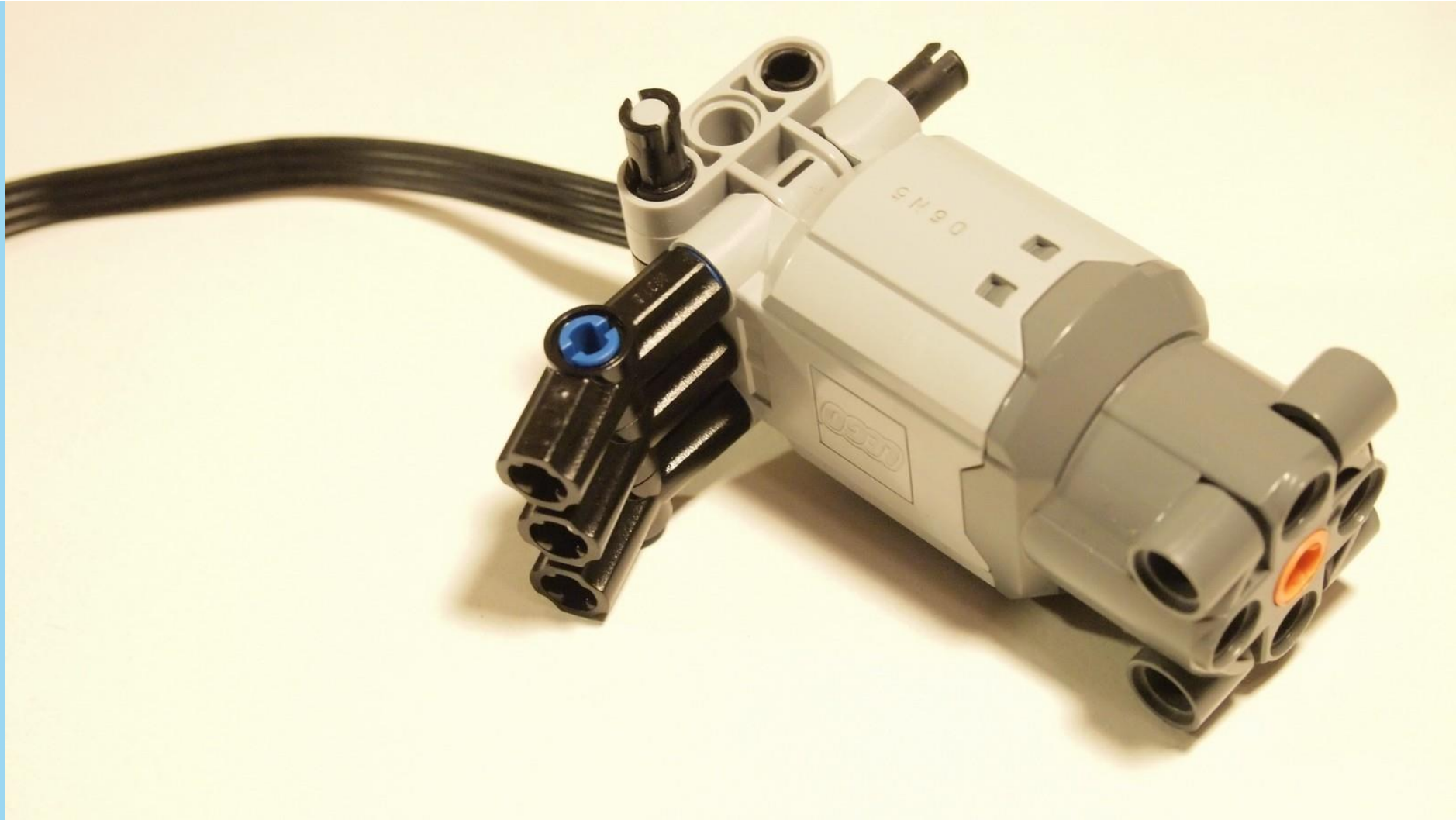



3x



1x



1x

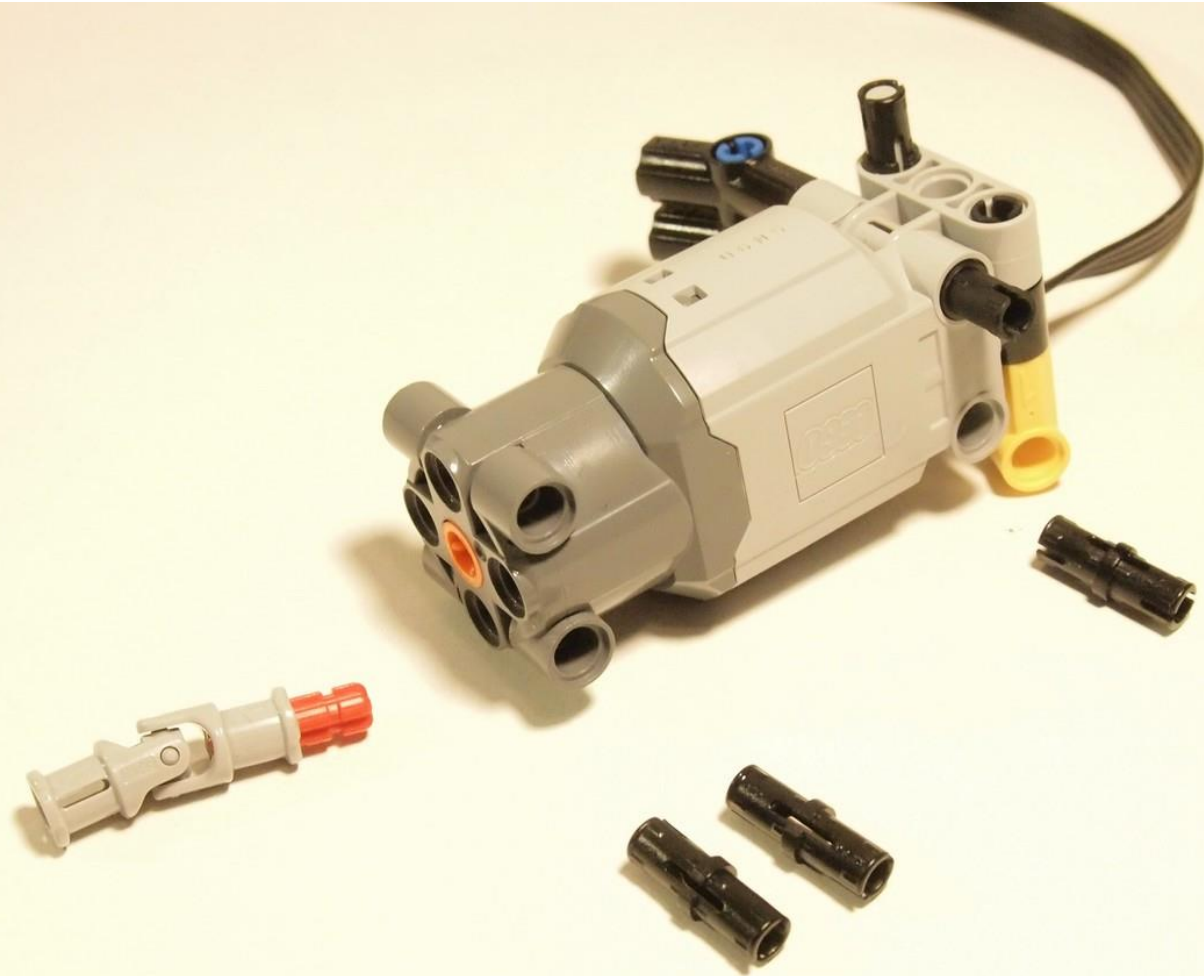



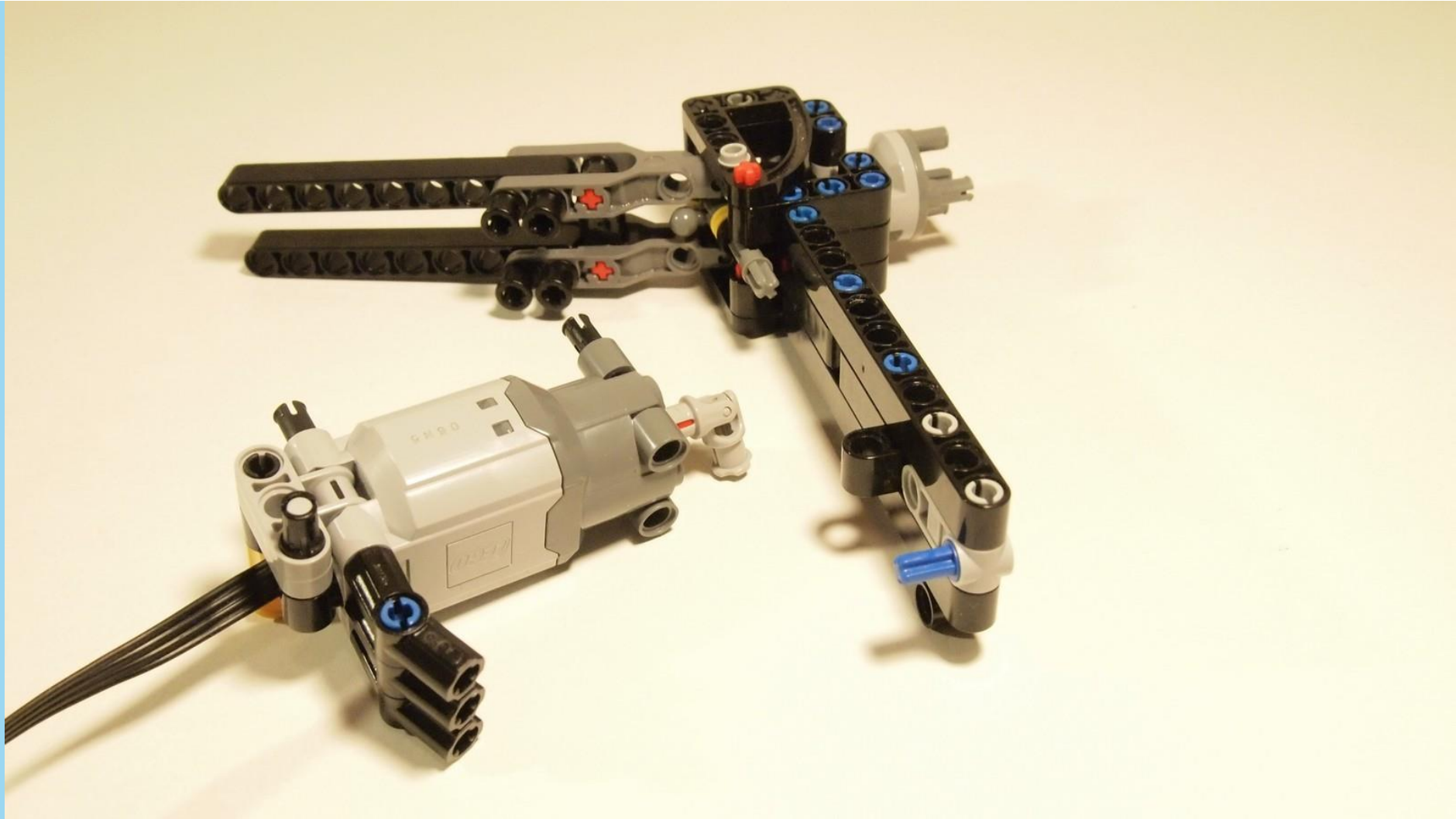

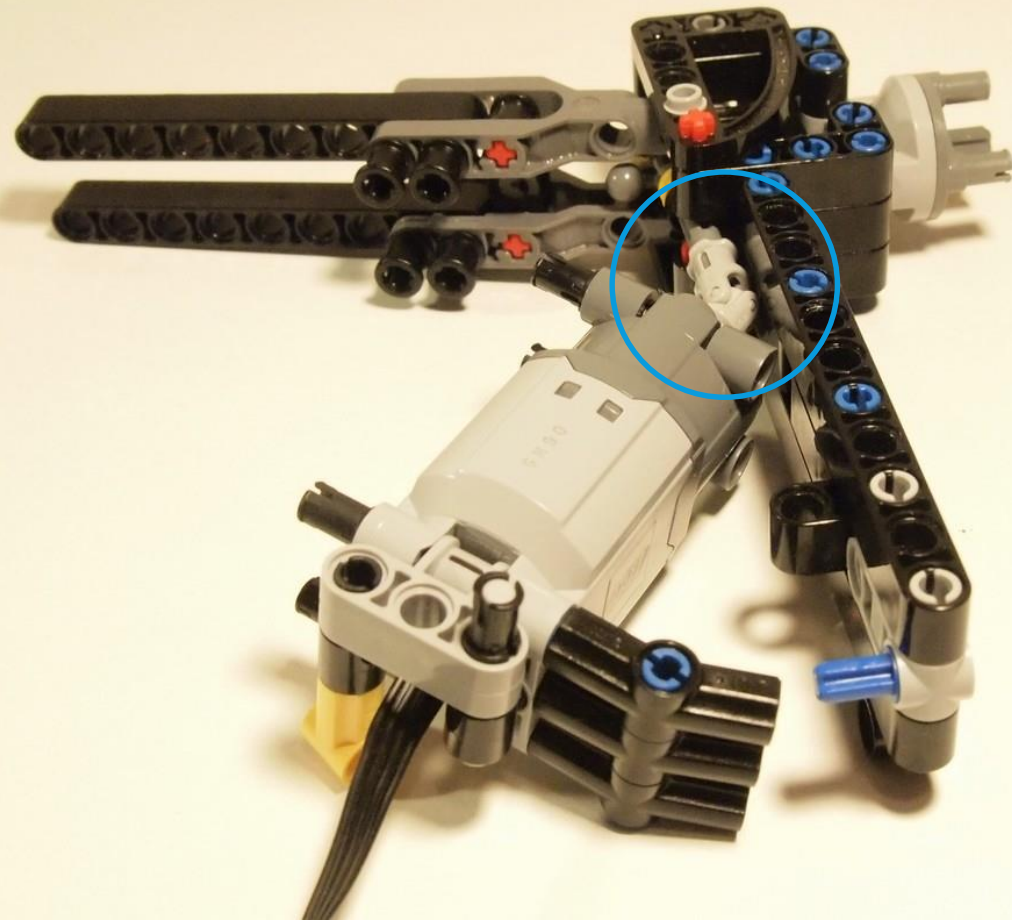

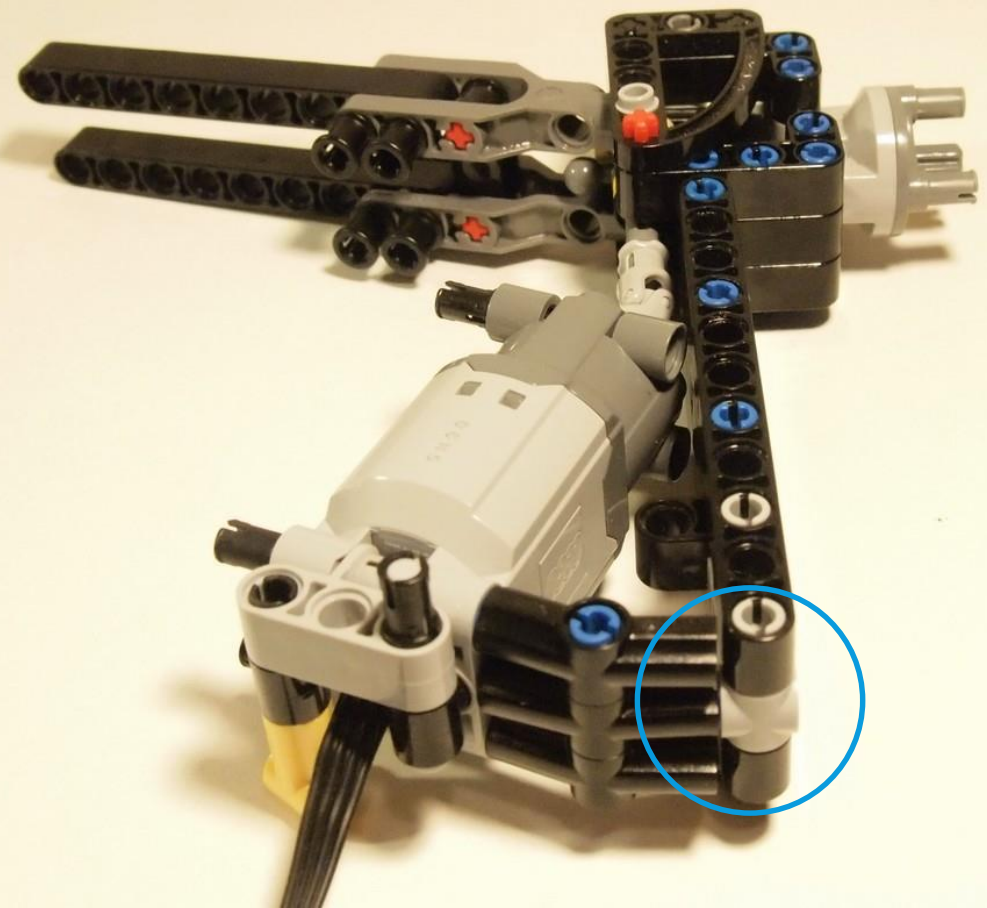



1x

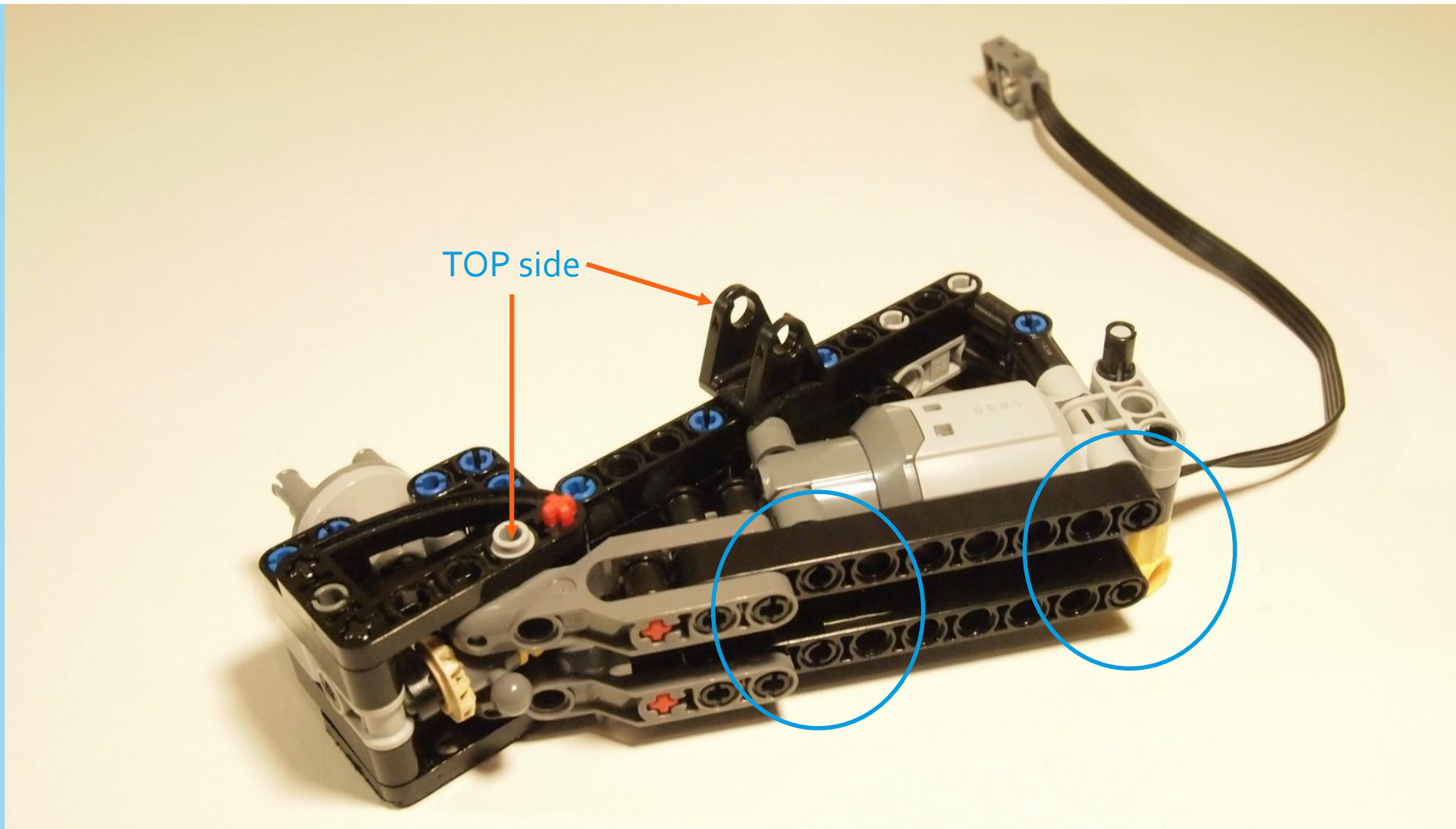



1x



1x



1x



1x

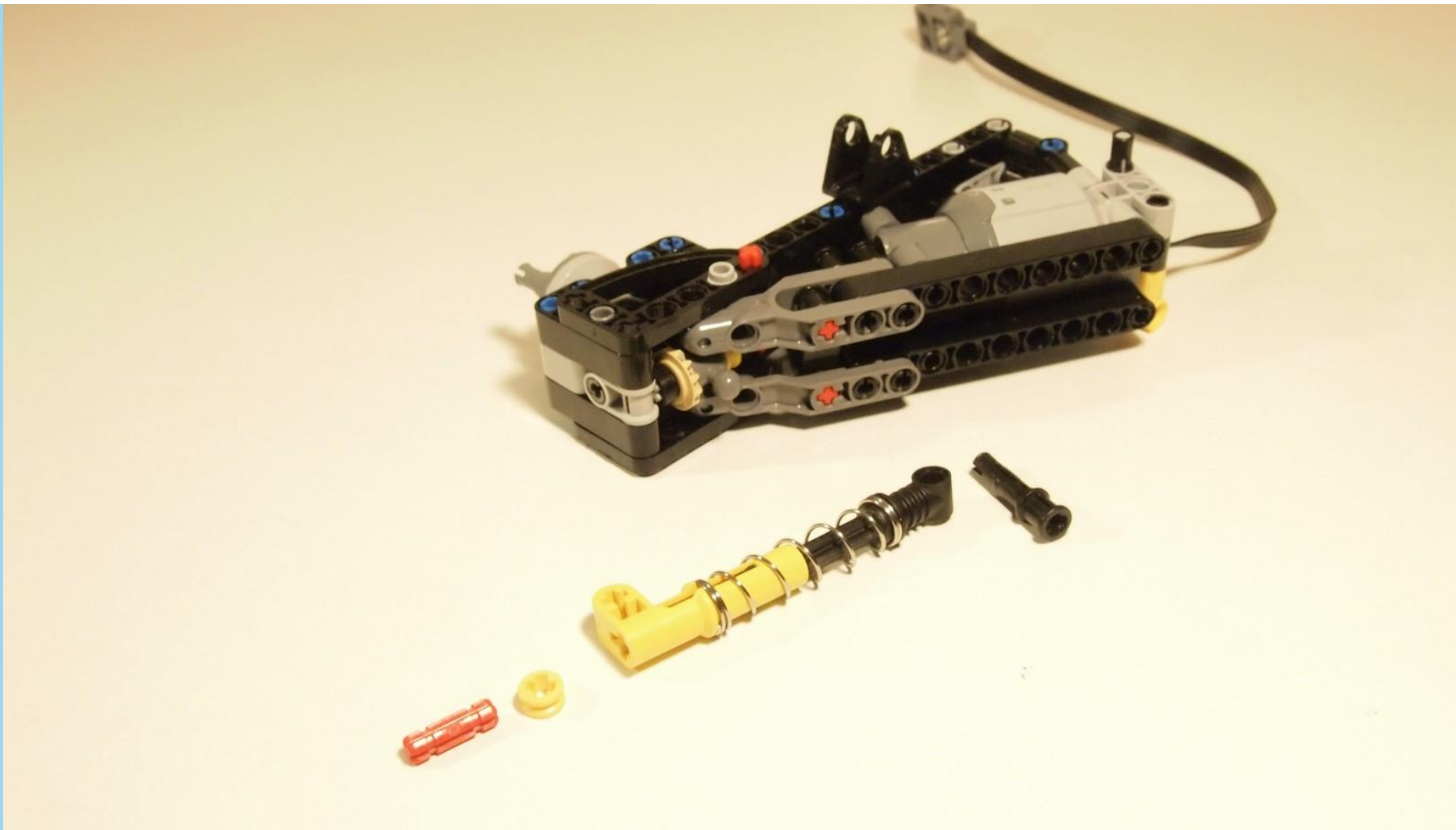

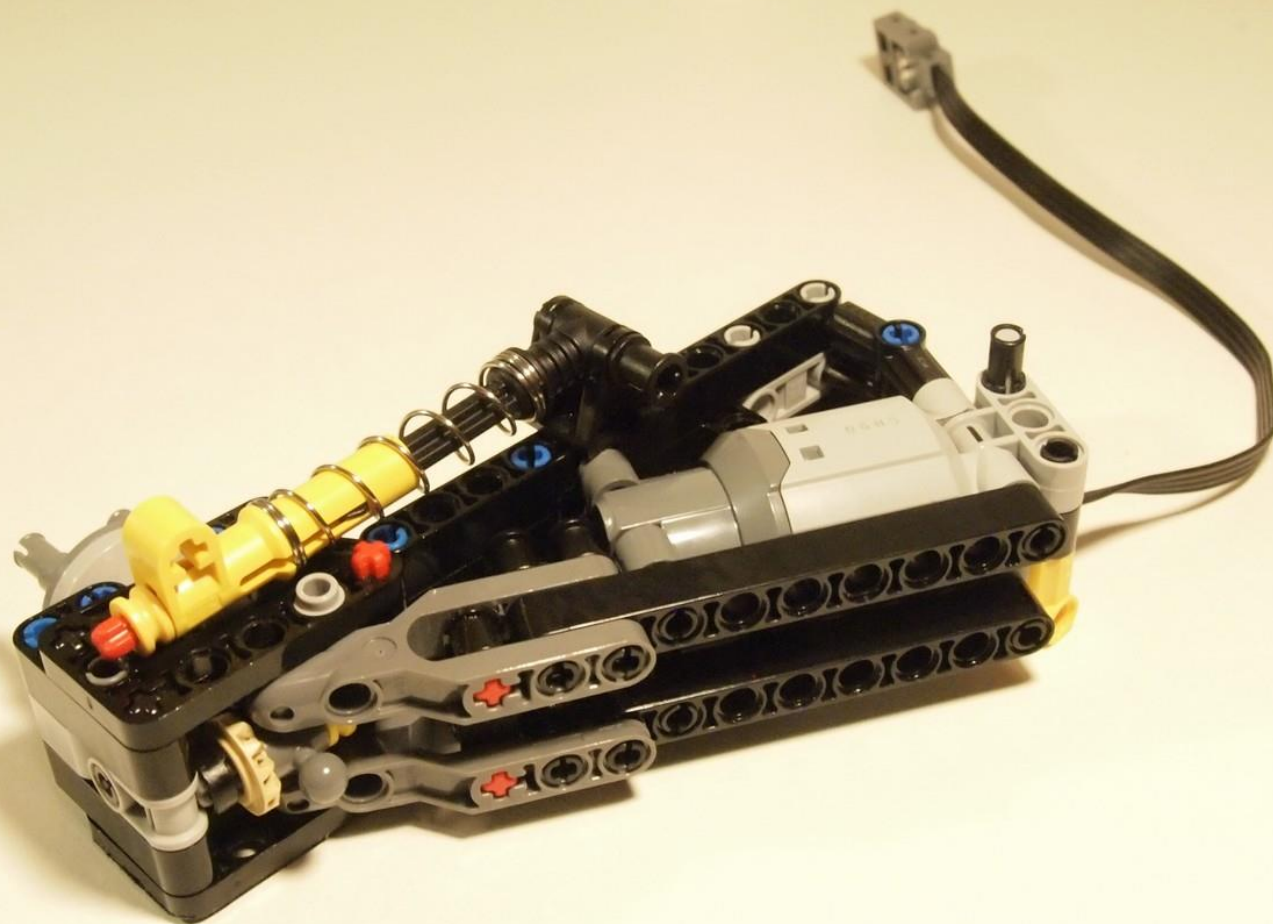



Repeat!

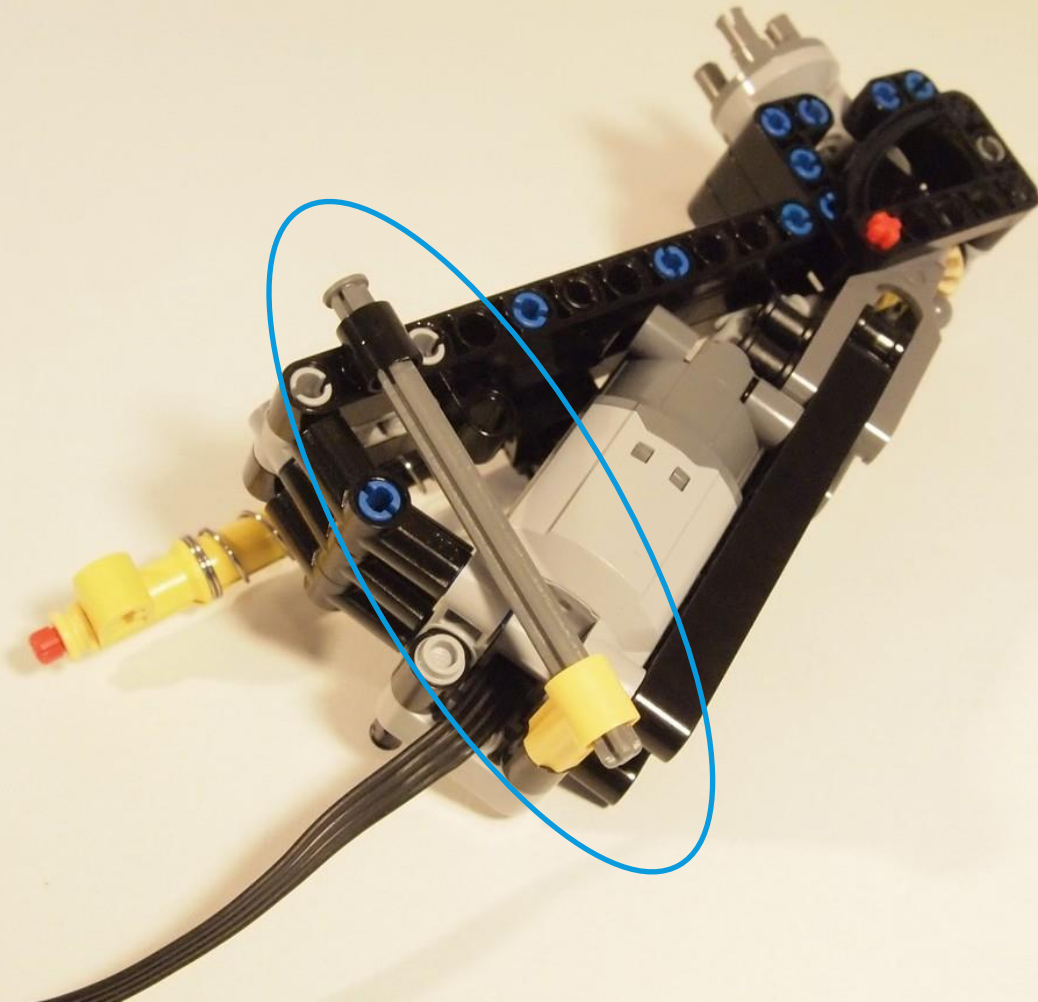

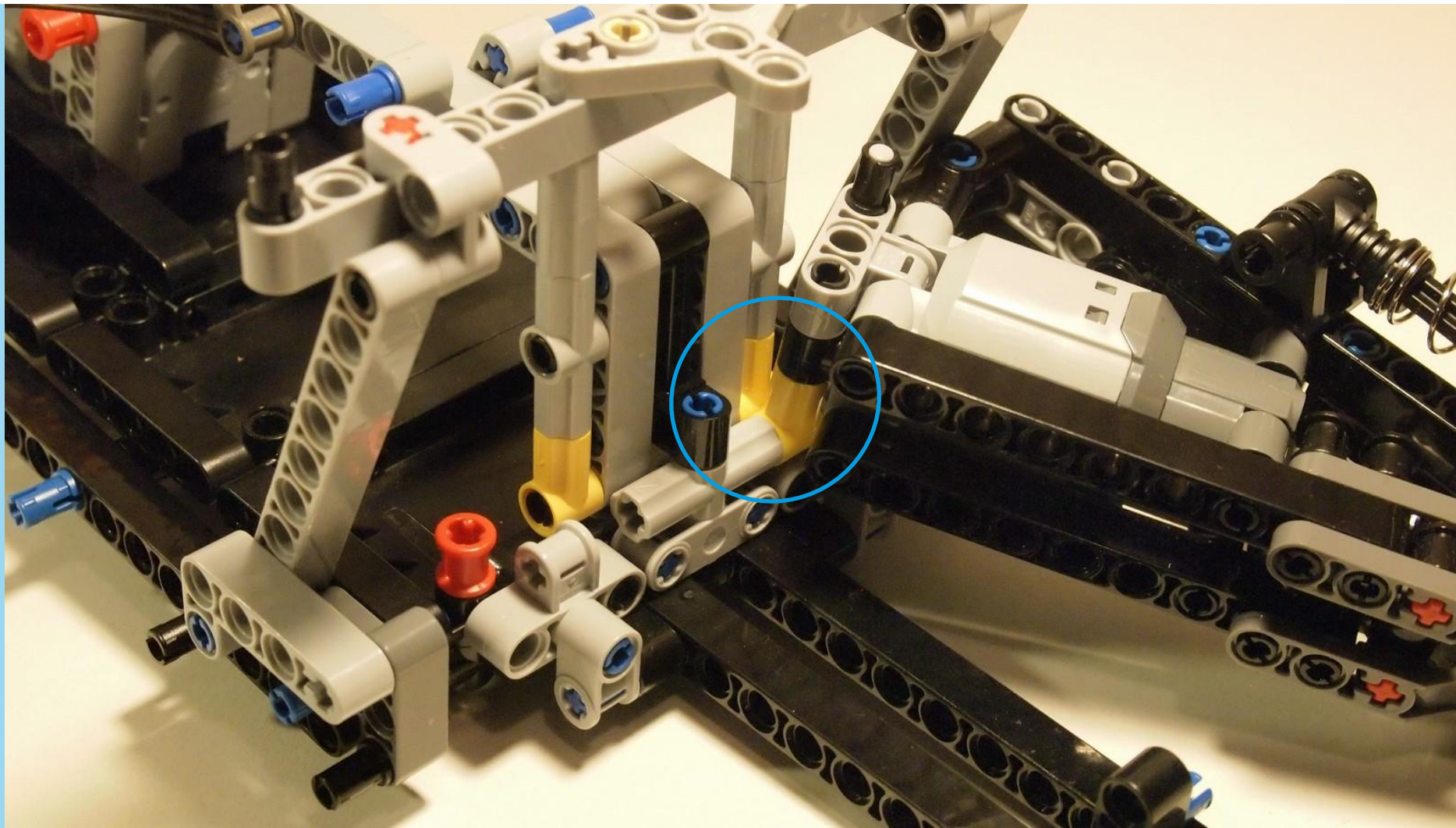

8



1x

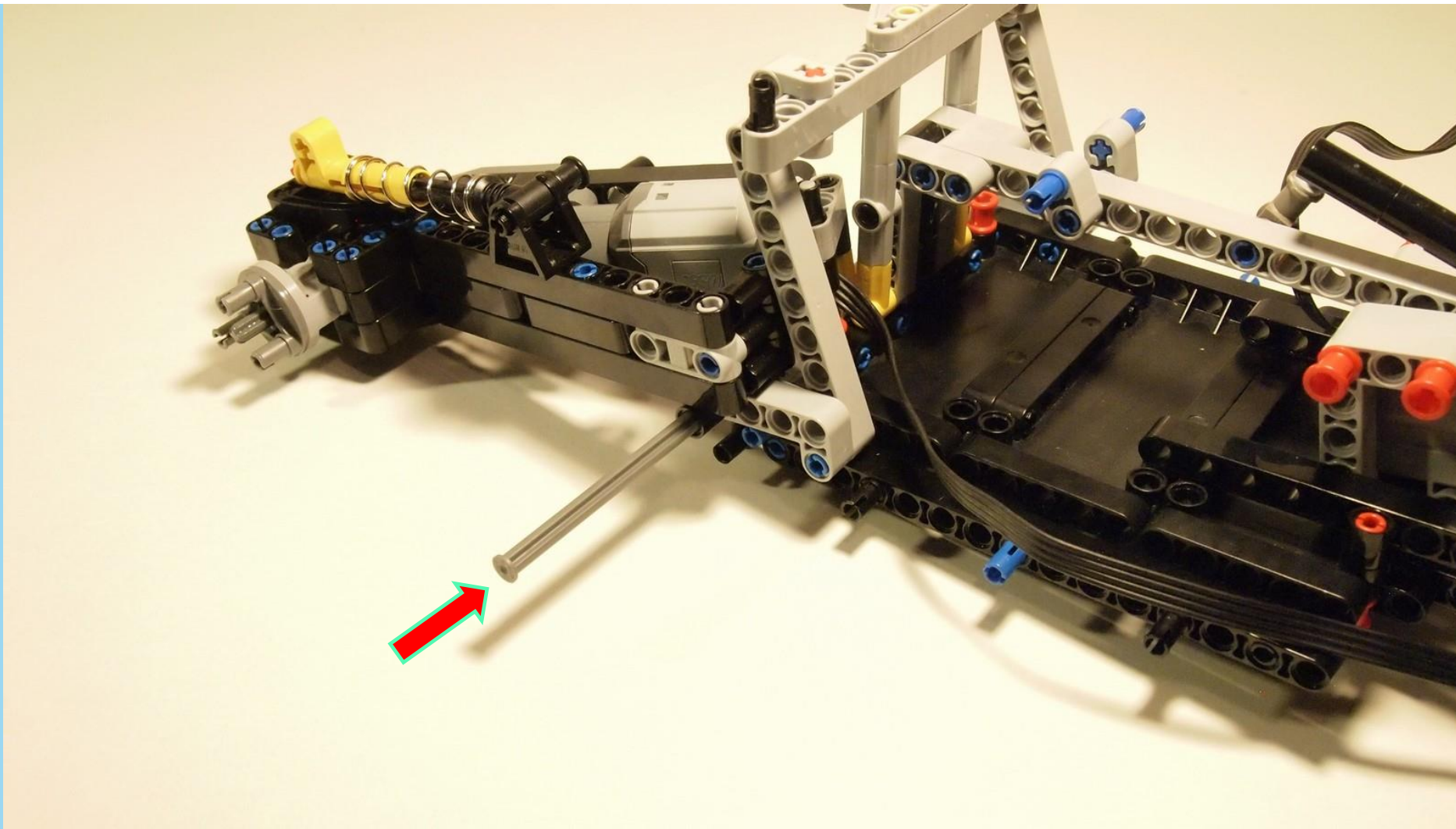

8



1x

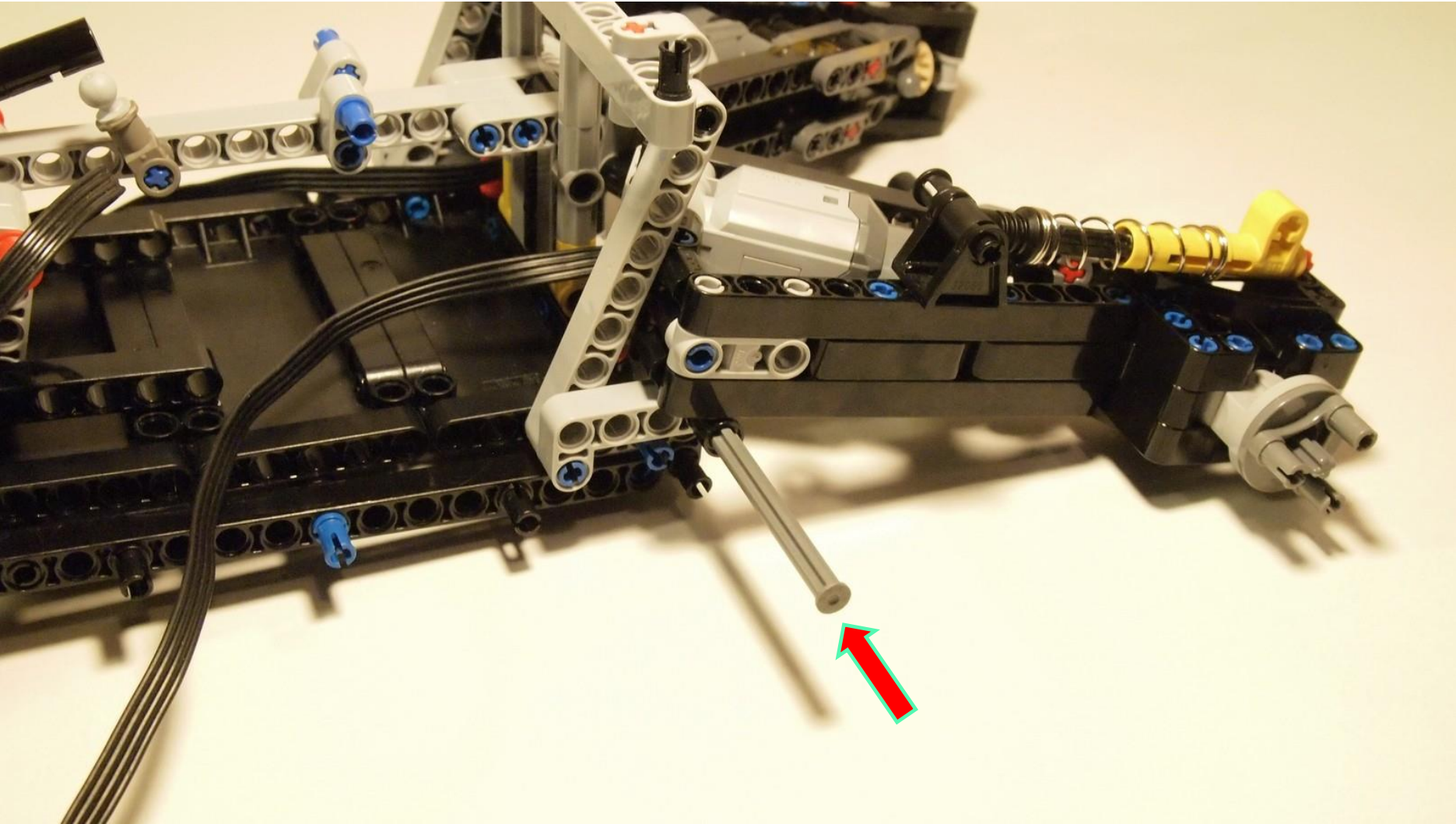

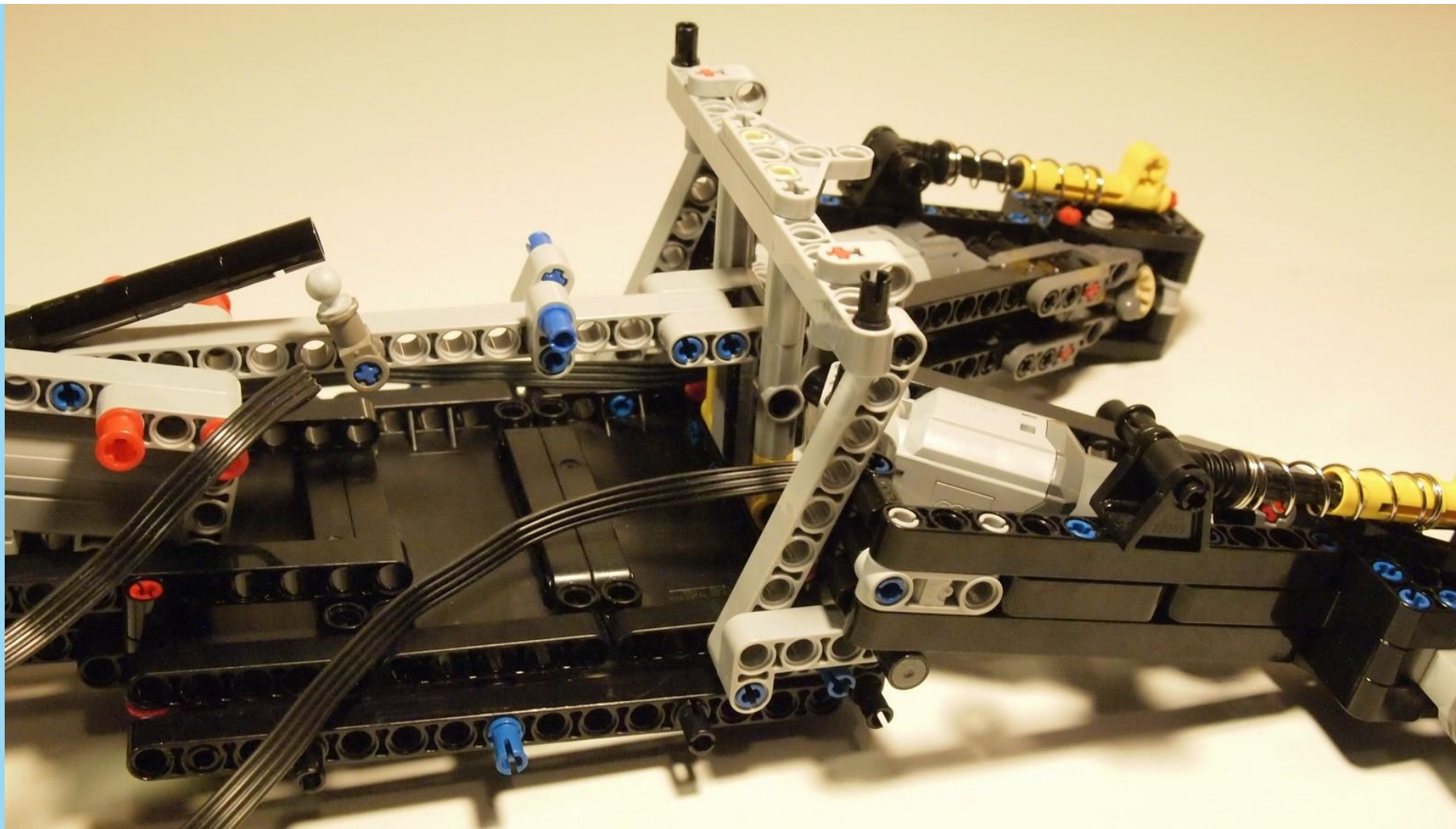



Servo wire

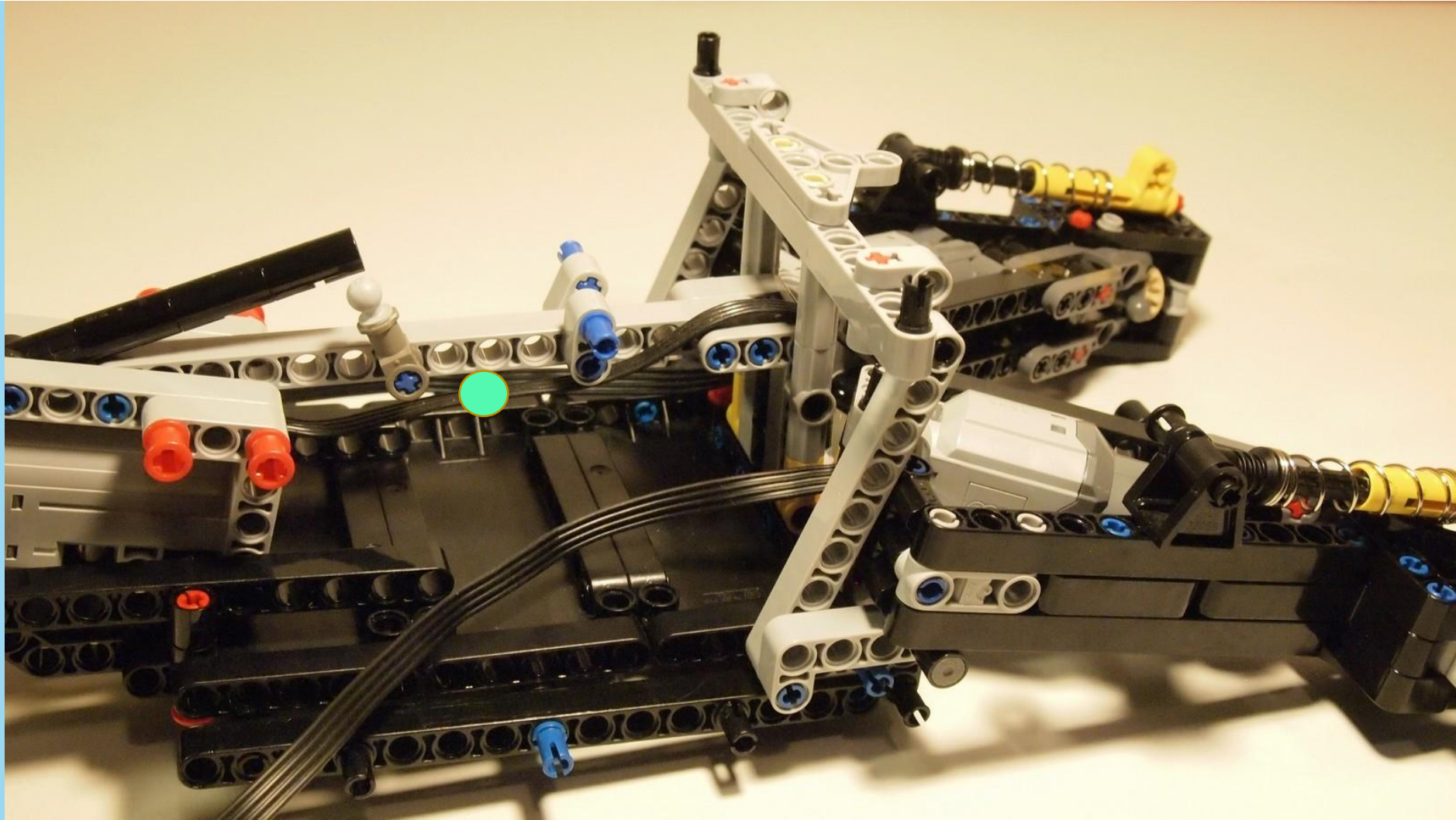

servo



Motor wires

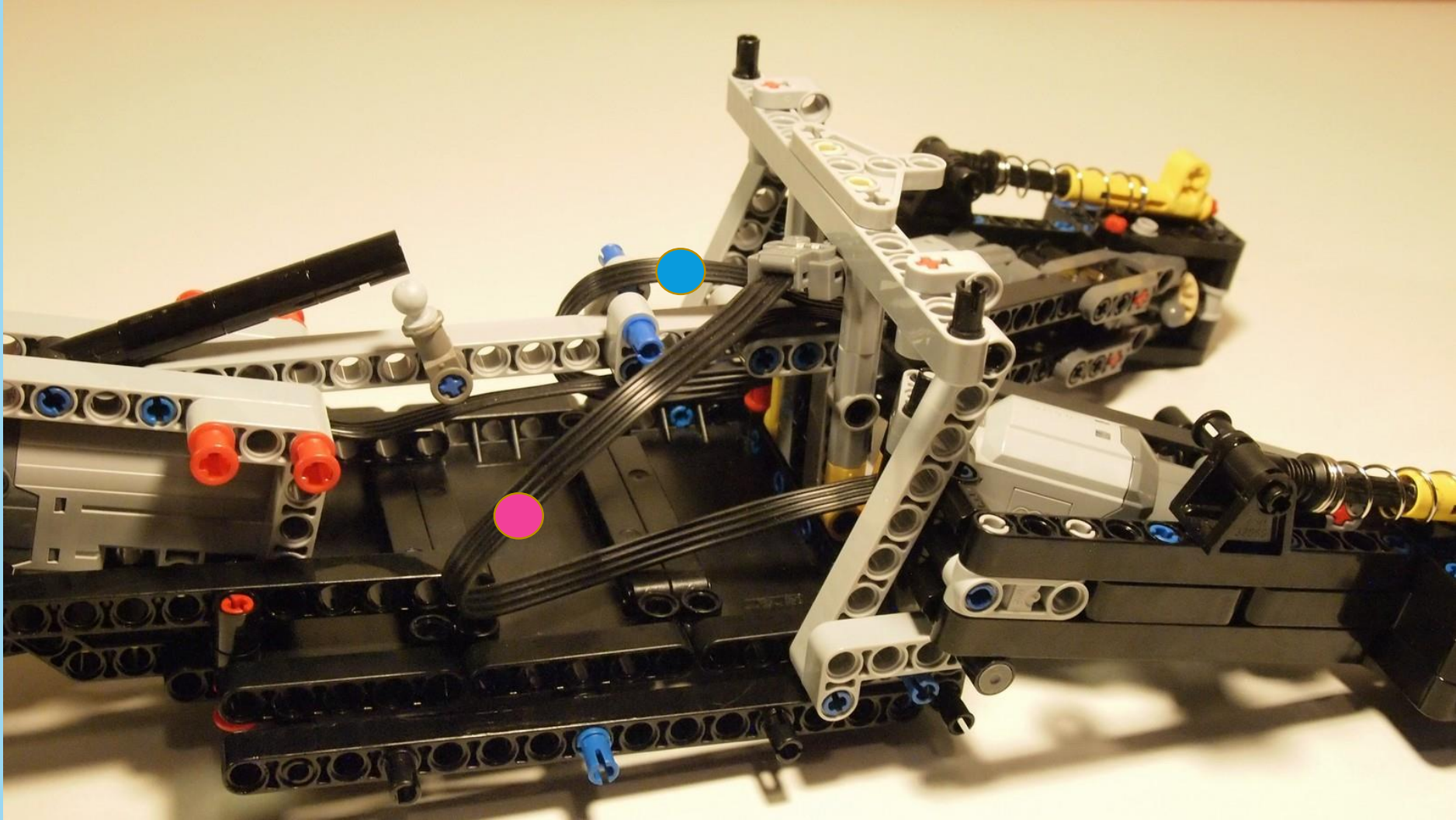

● motor left
● motor right



Smooth...

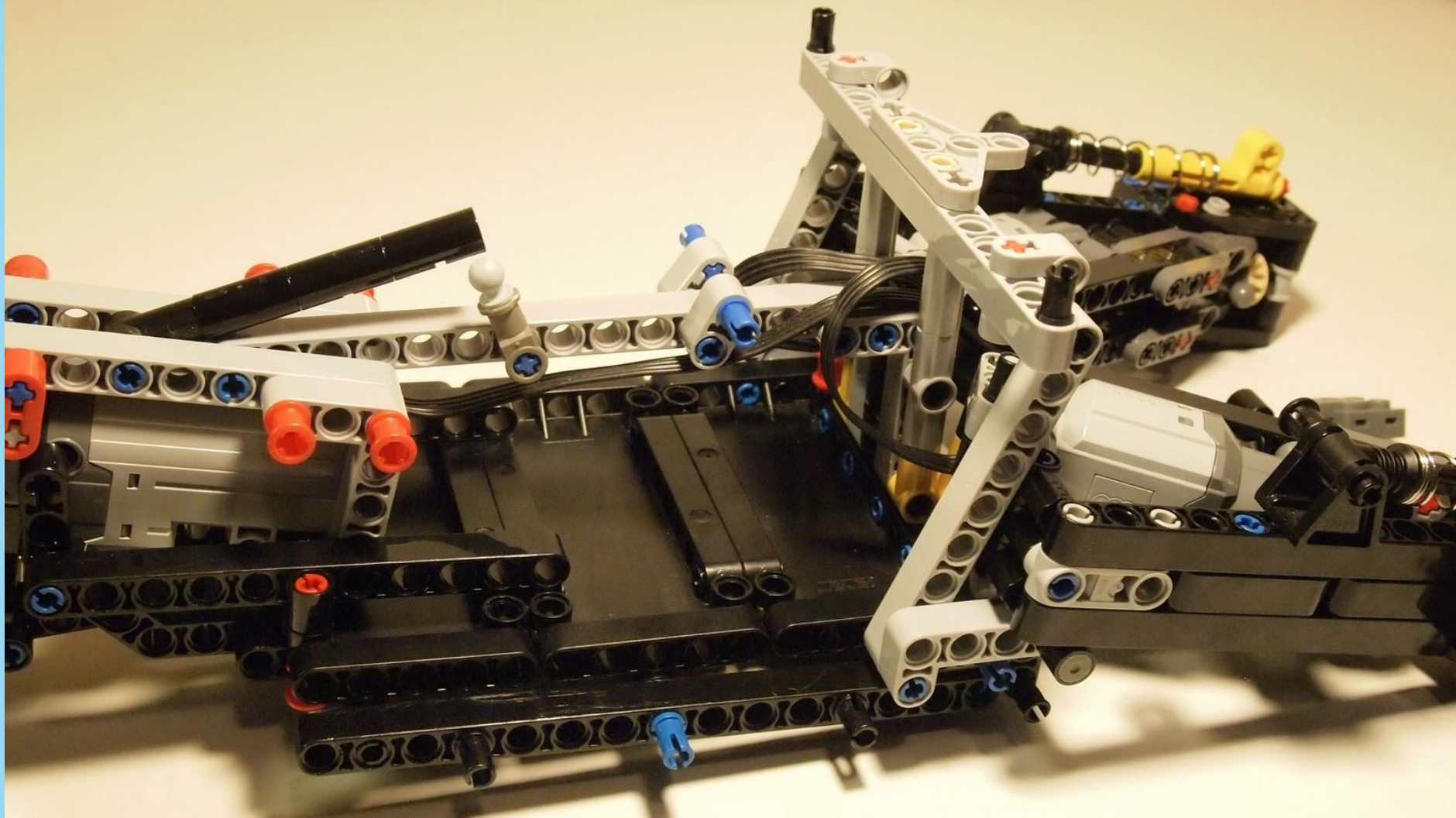



1x



Front led wire

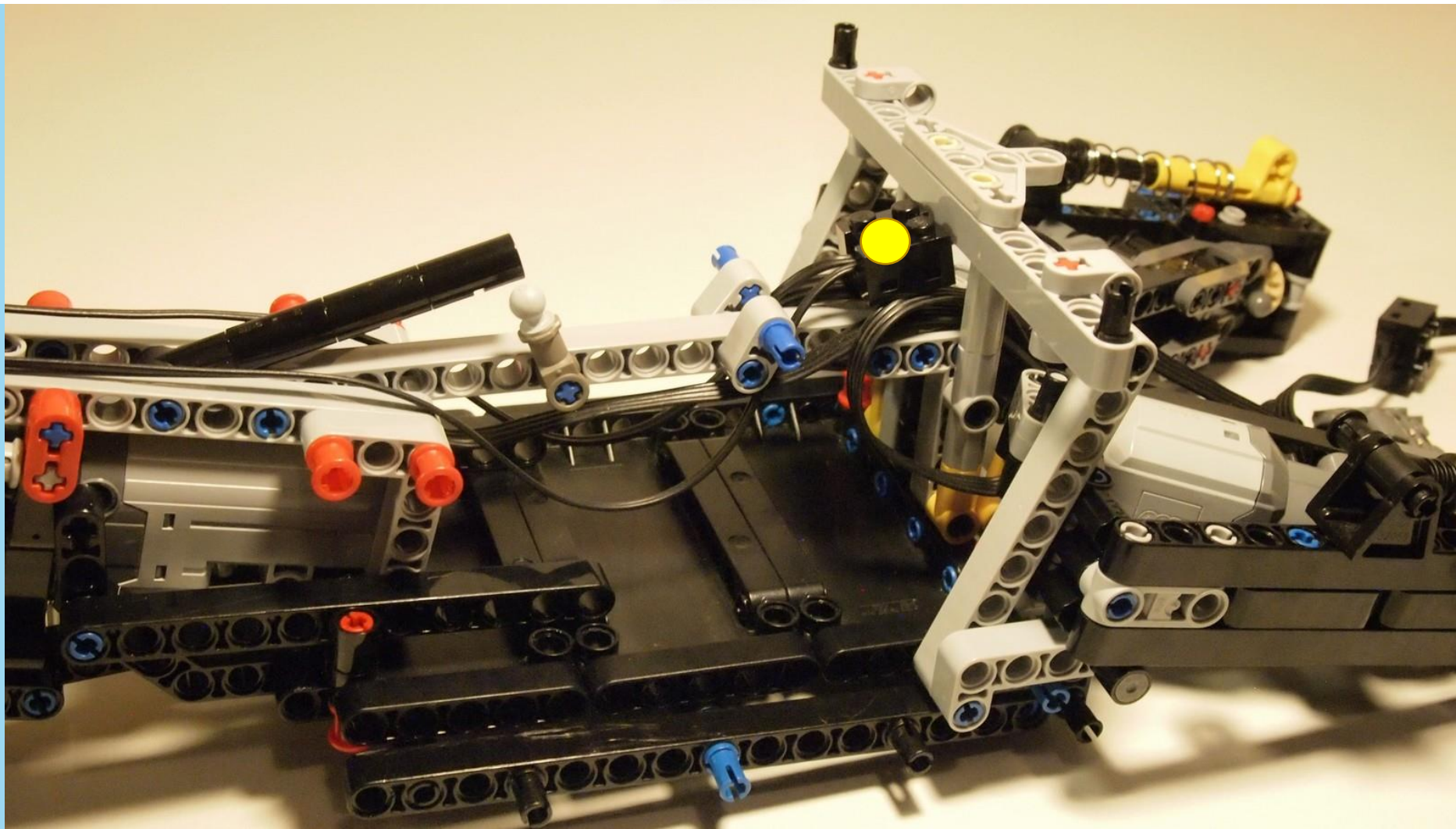

● front led



Front led wire

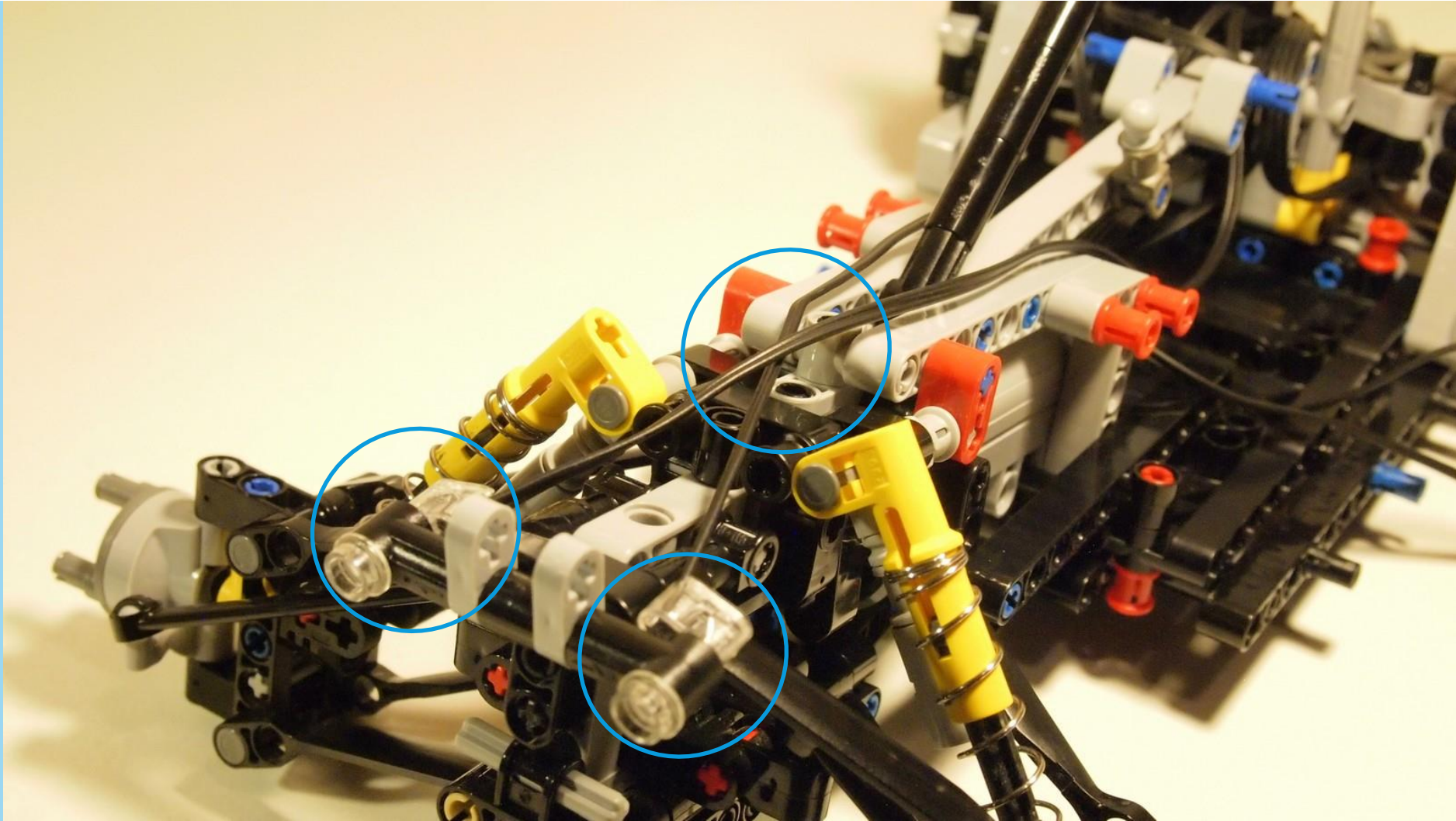

● front led





1x



Rear led wire

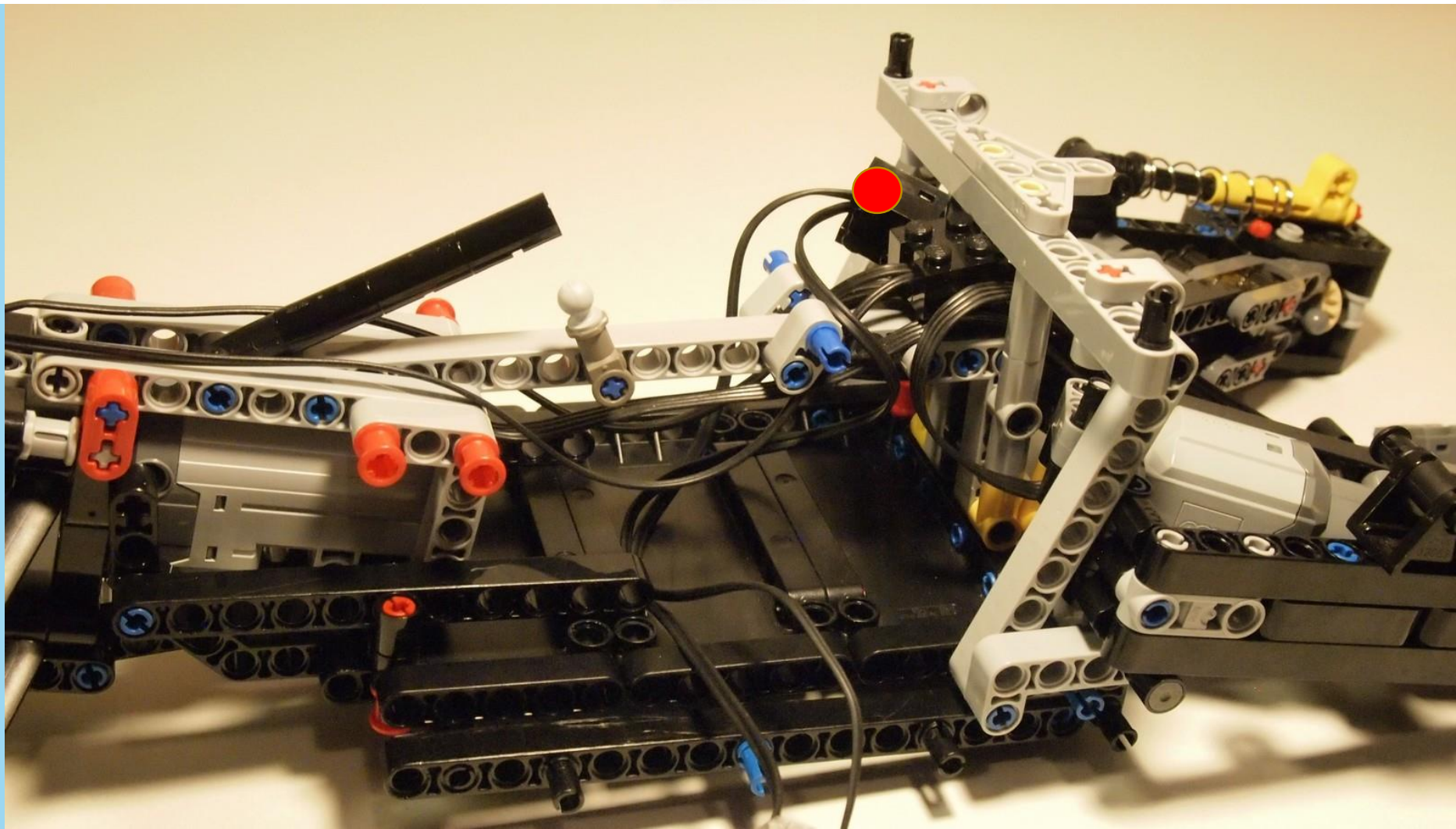

● rear led

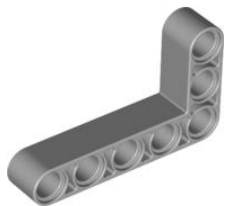

2x



2x



2x



4x



right



left



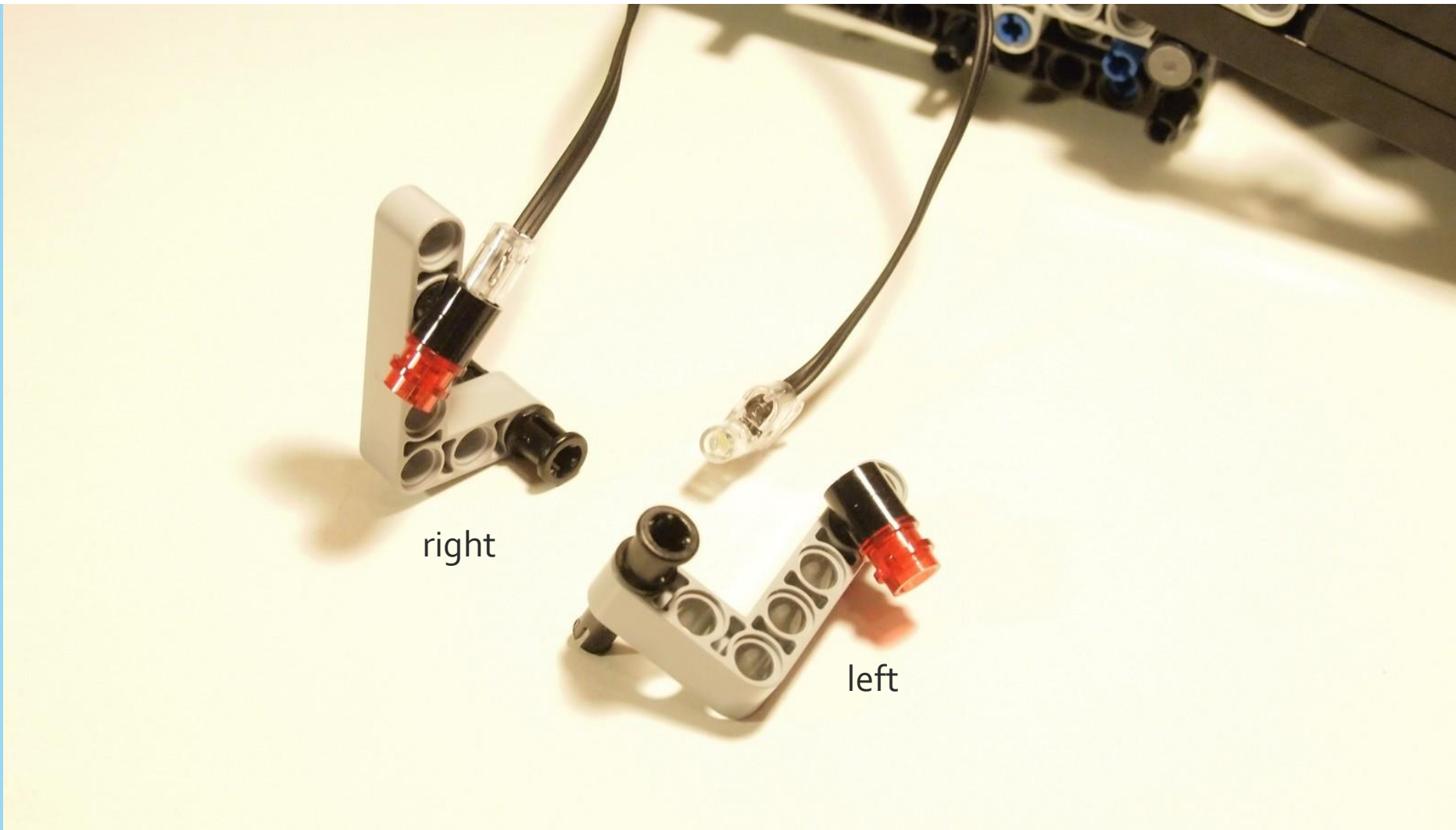

right

left

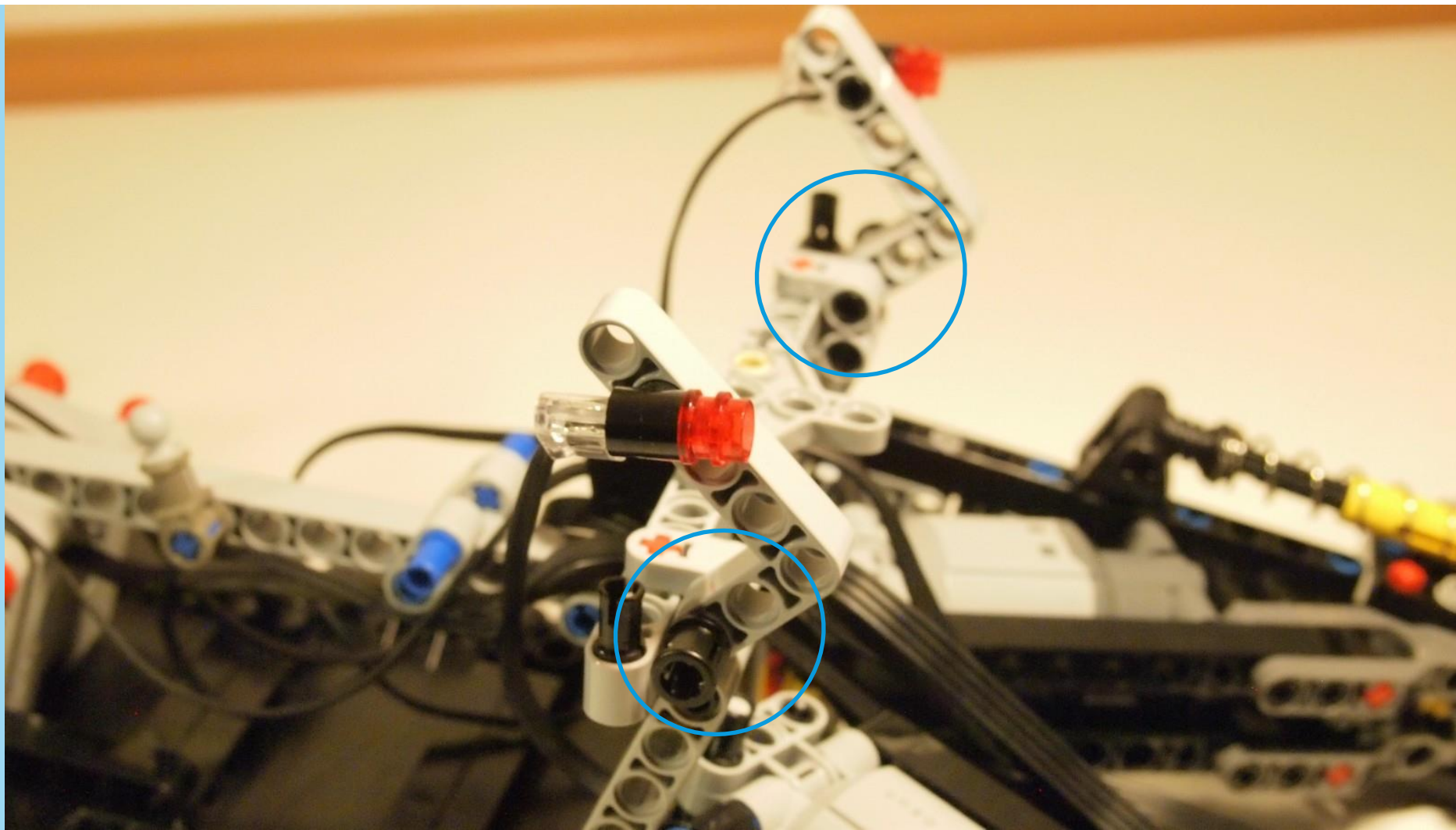



2x



1x



1x

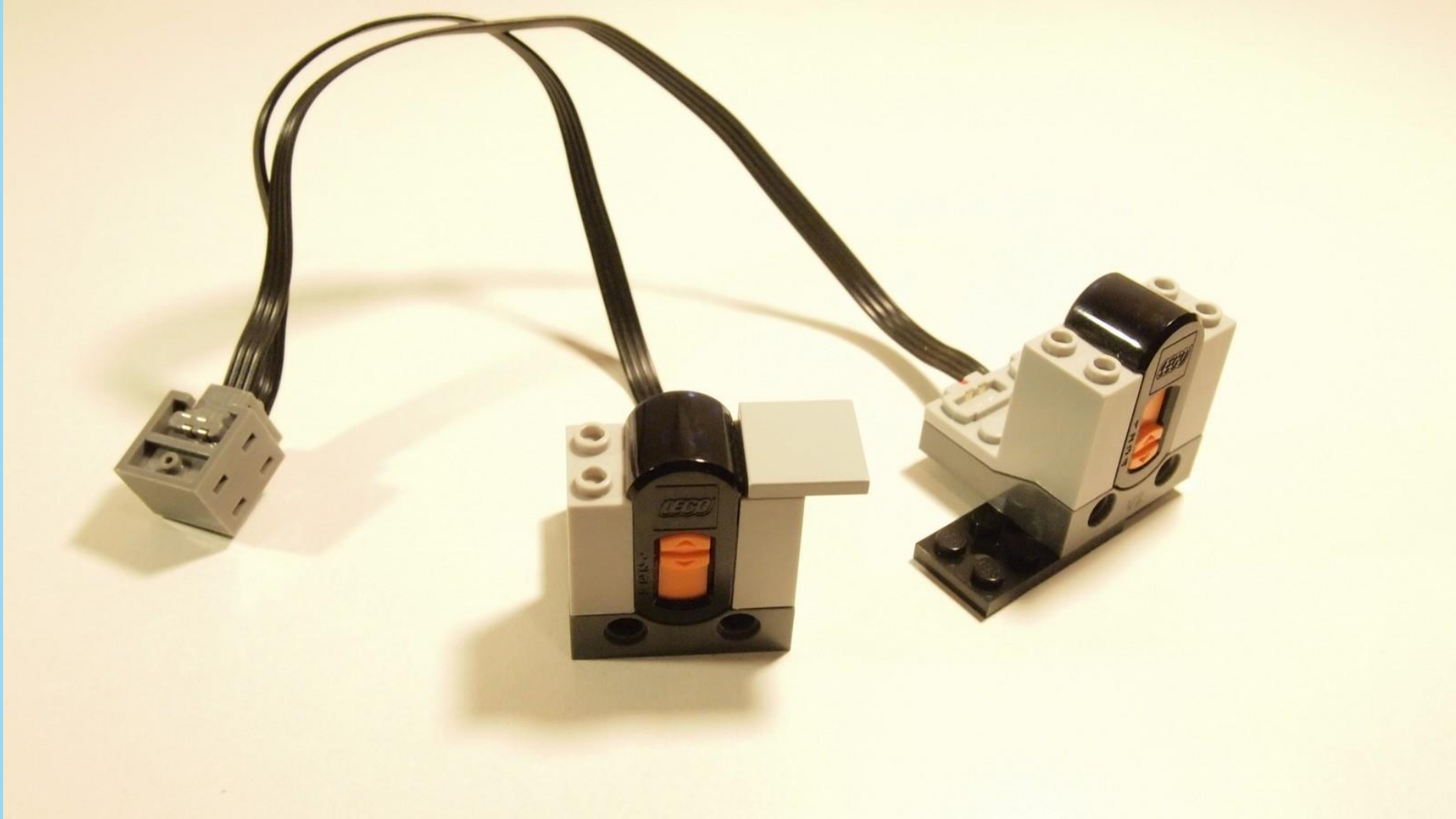

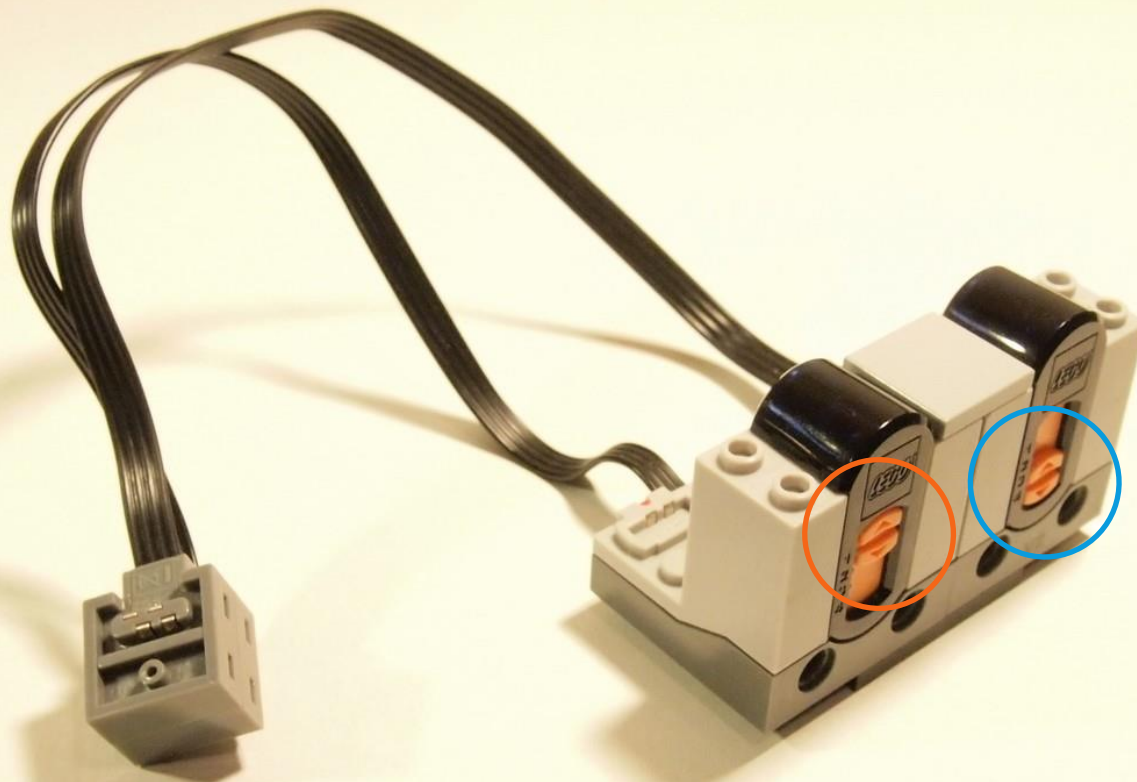

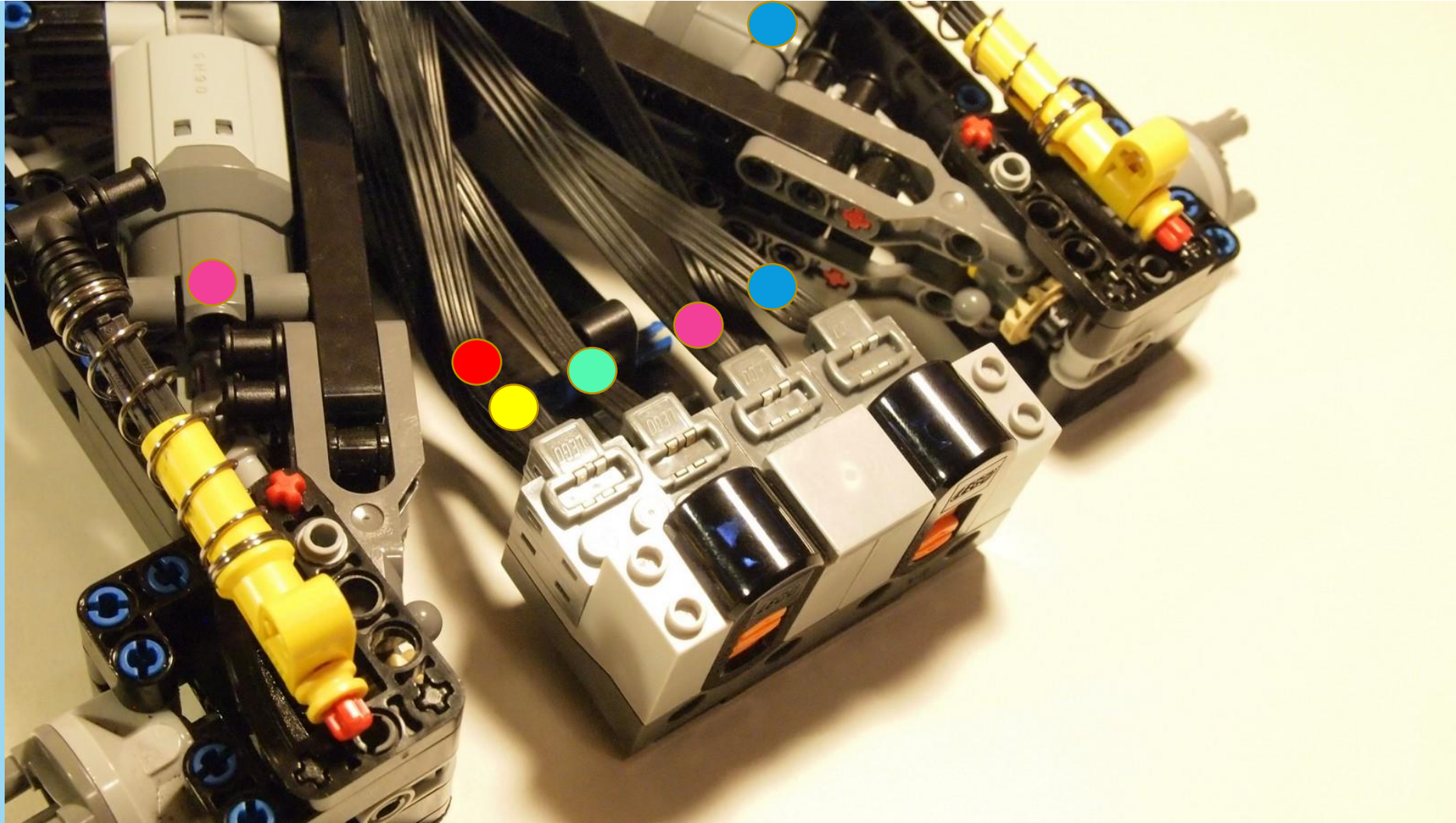

● rear led

● front led

● servo

● motor left

● motor right



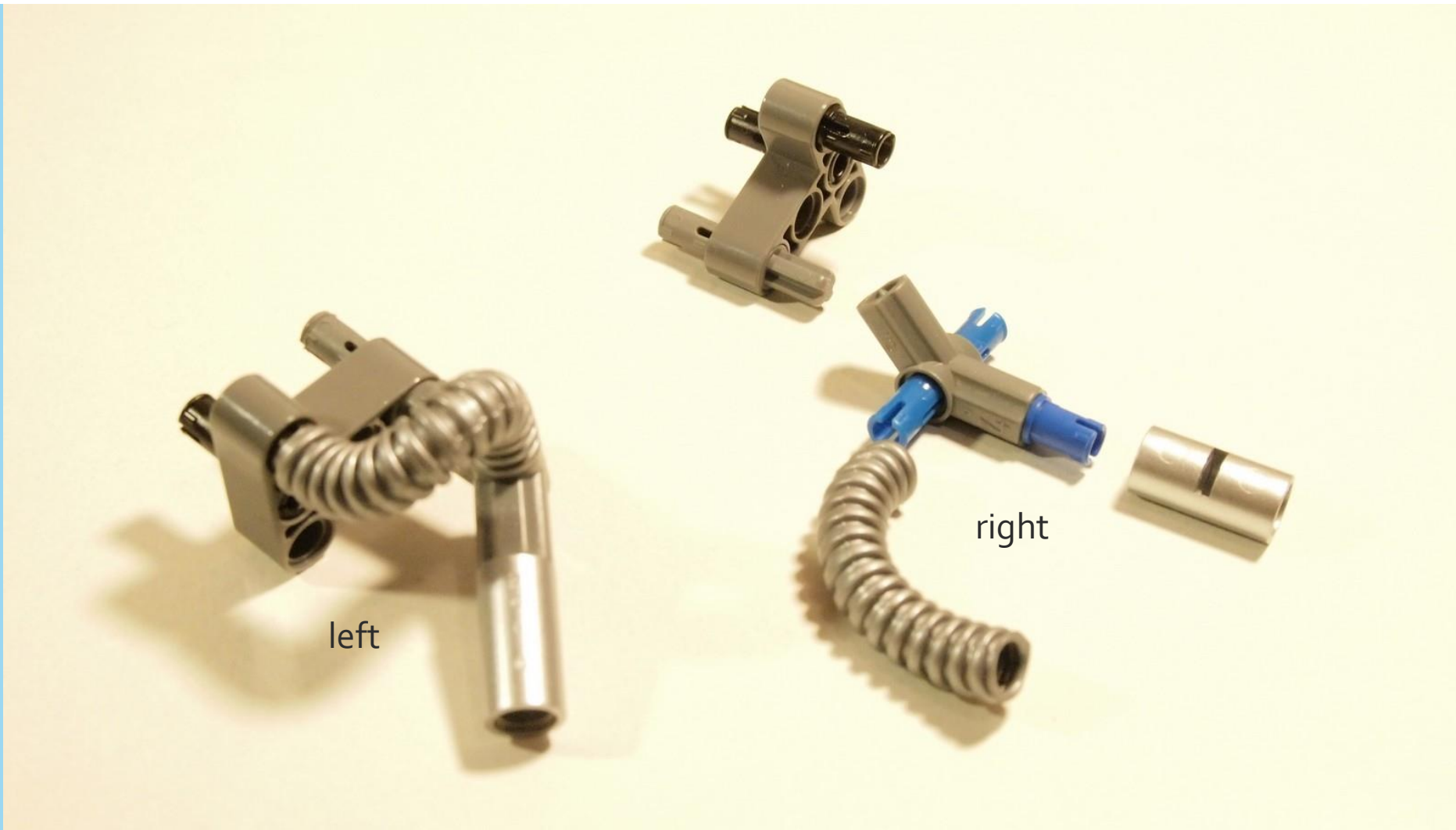
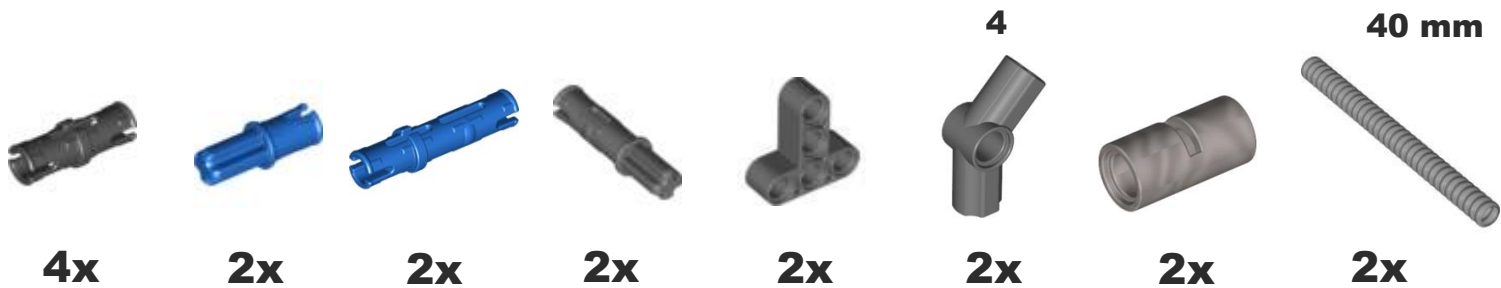

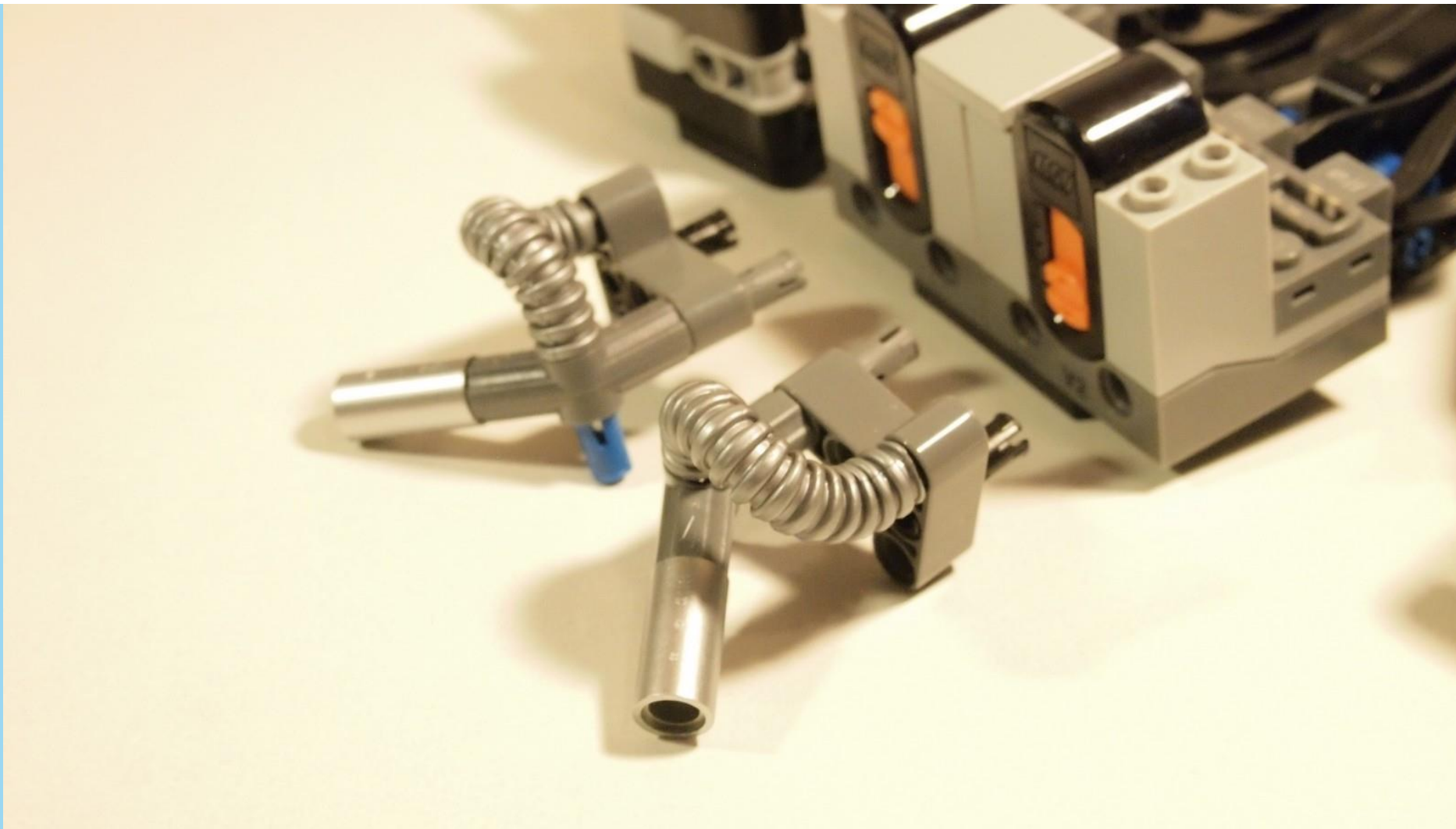

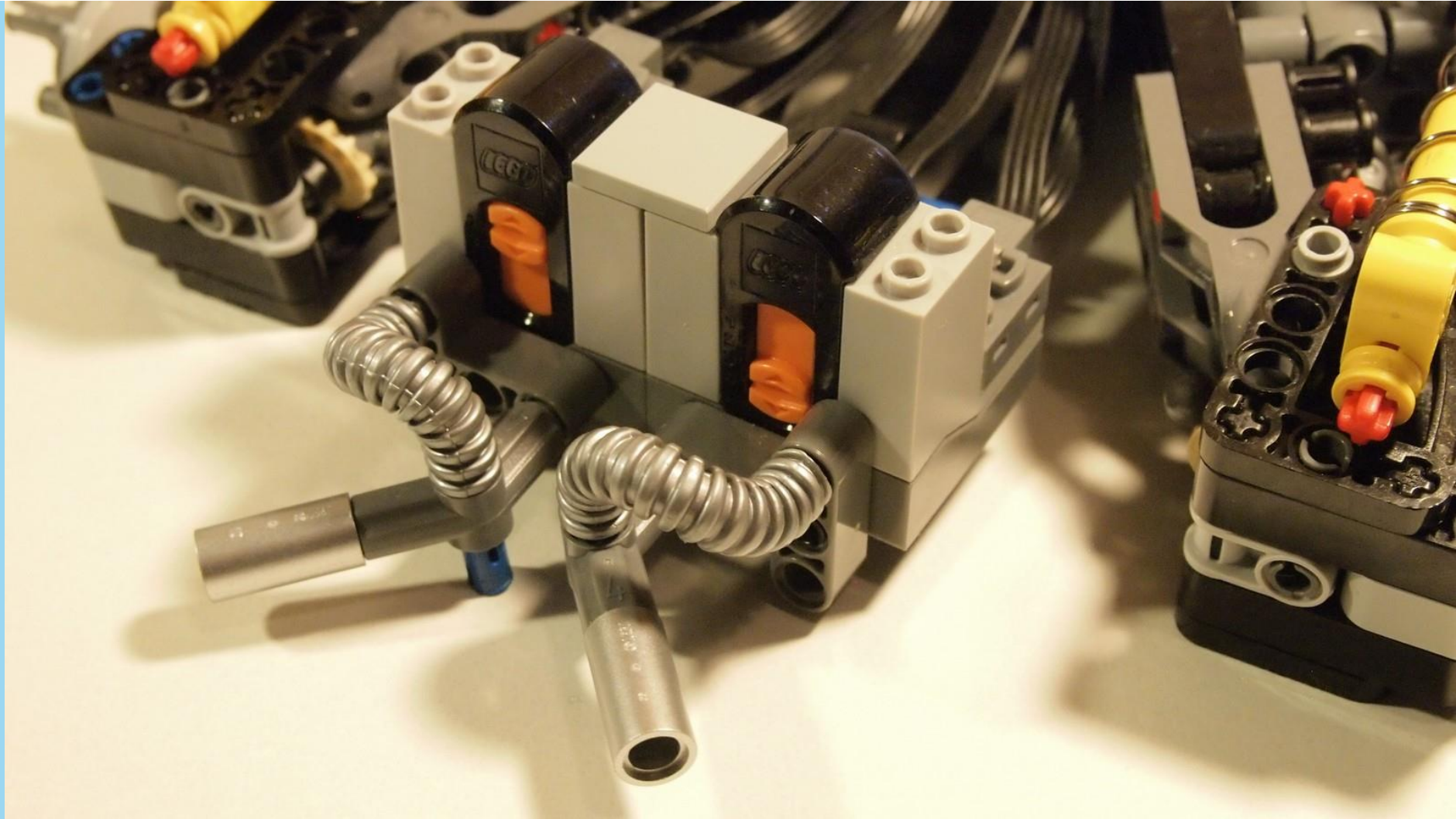



1x



1x



2x



1x



1x



2x

4

4

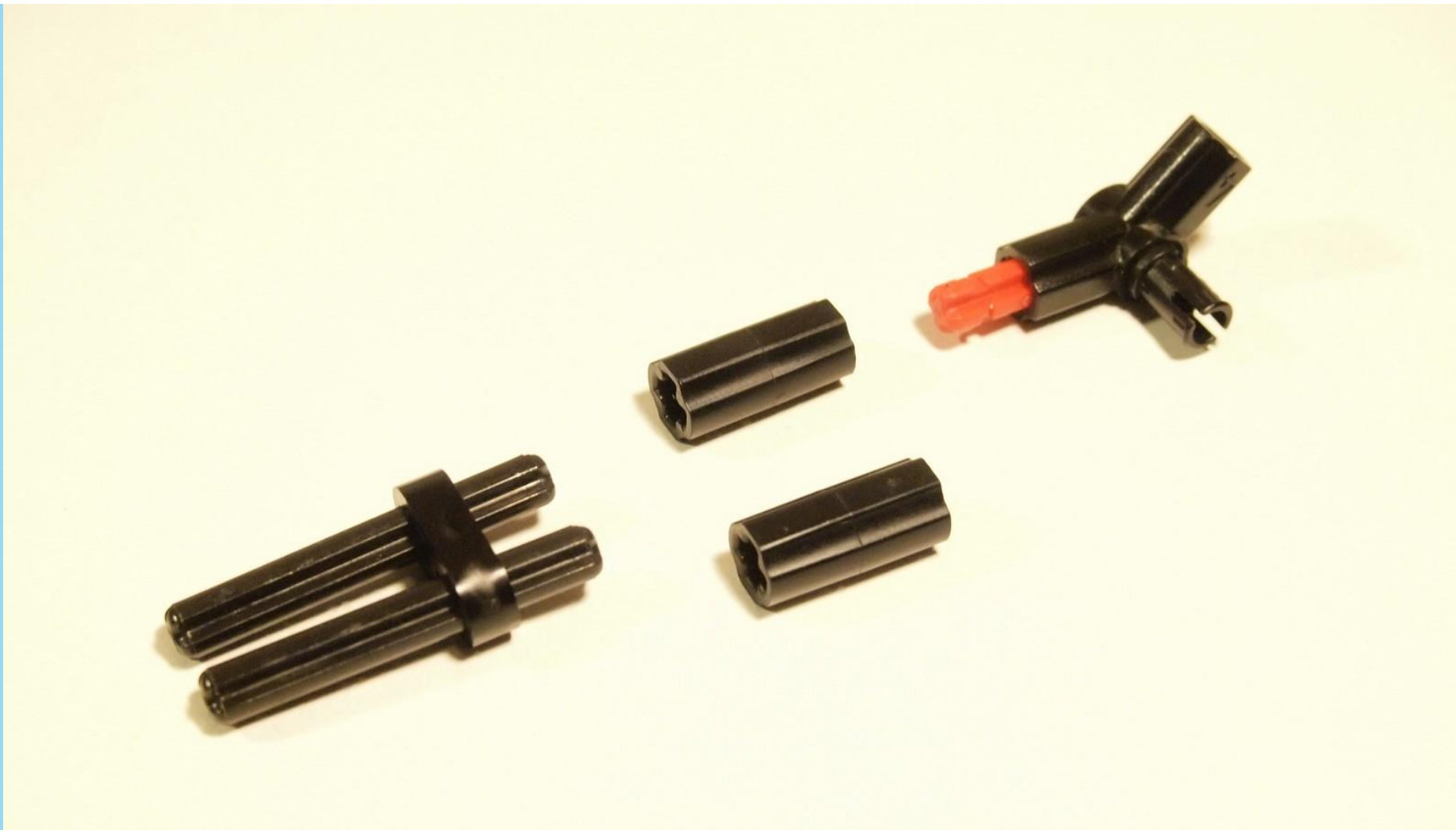



1x



1x



2x



1x



1x



2x

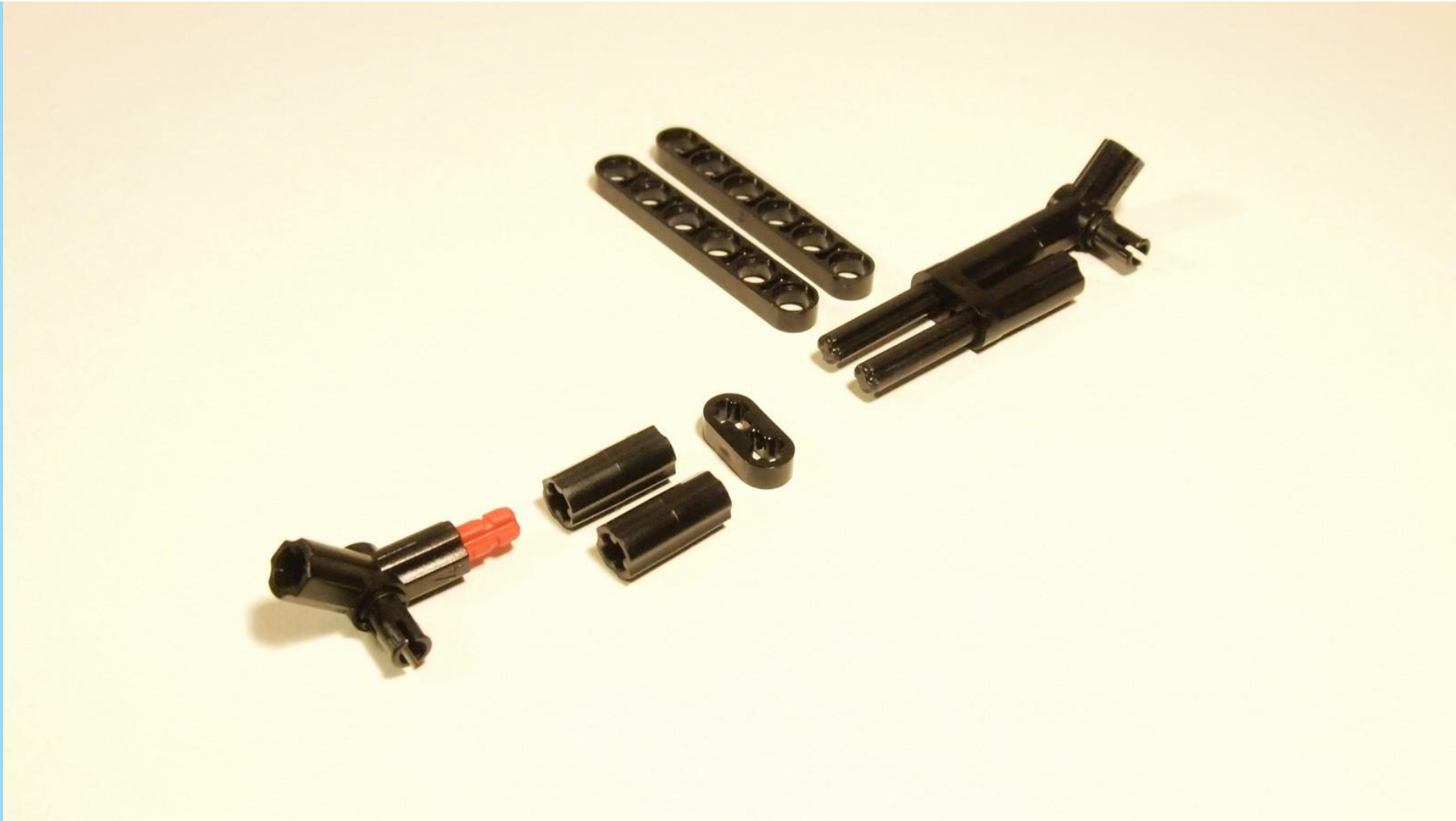

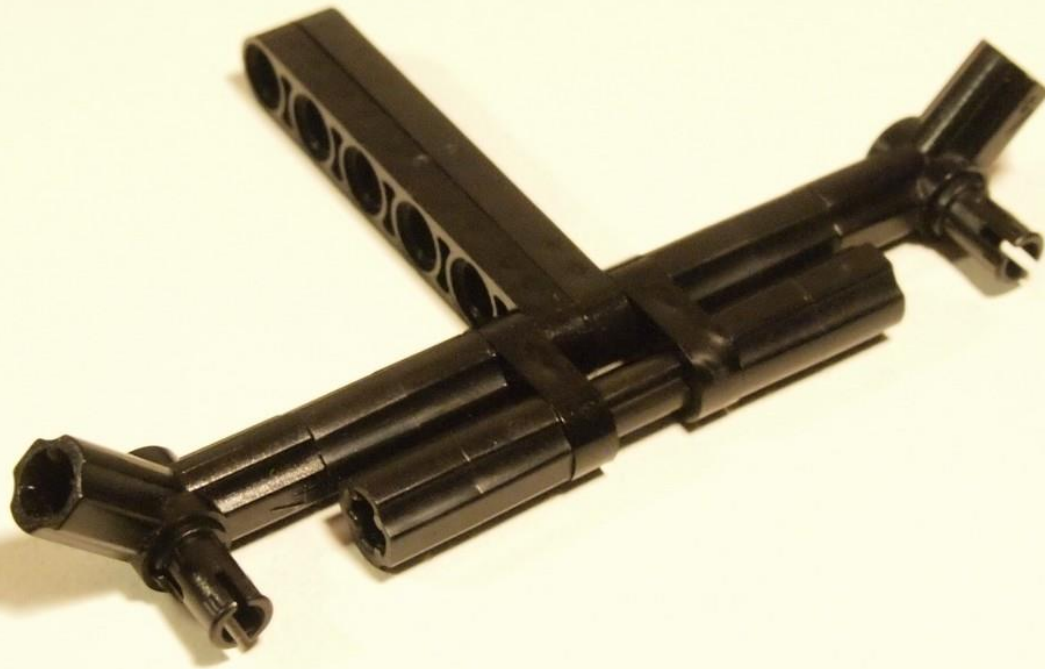



1x

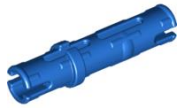

2x



1x

3

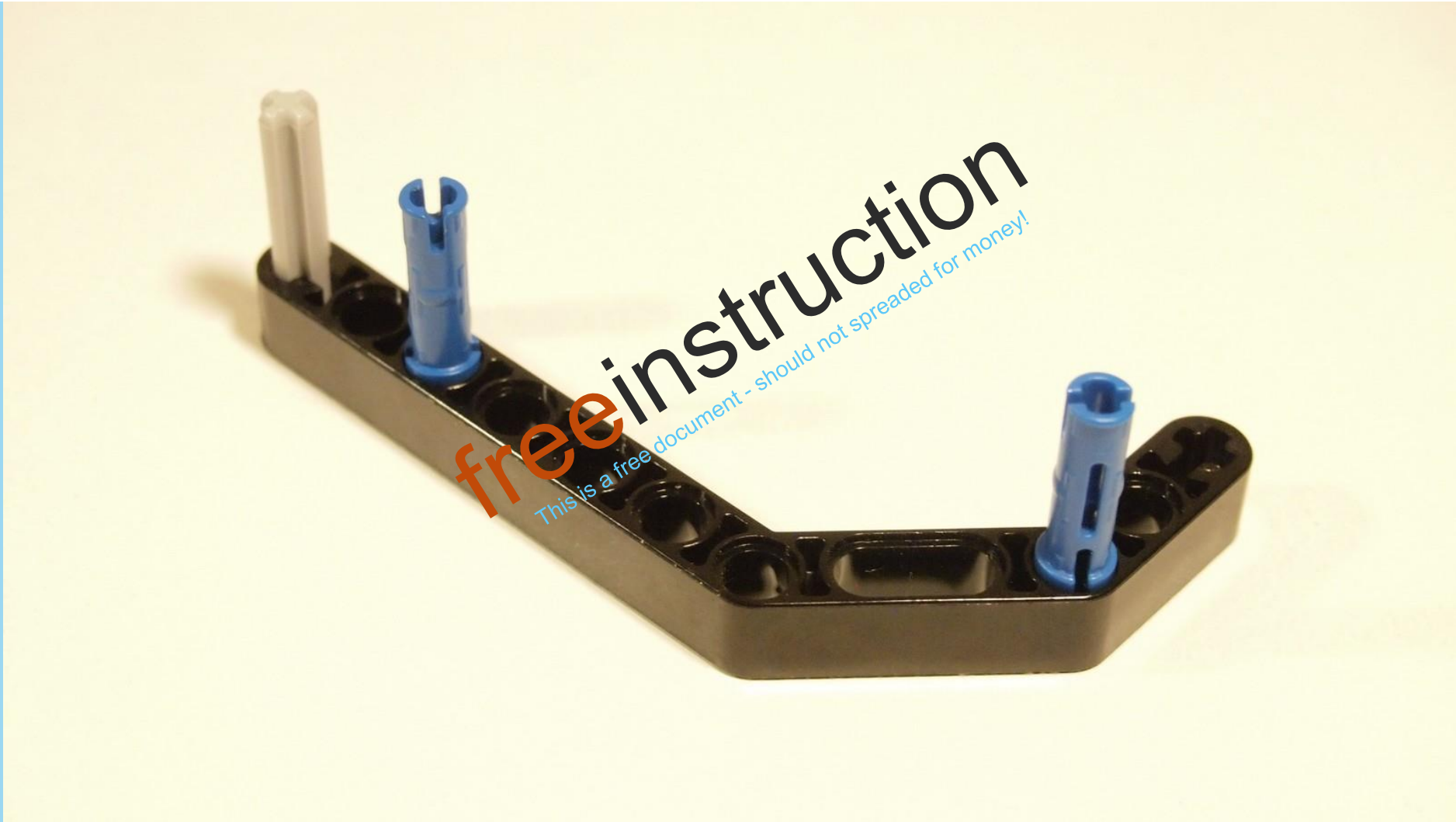

freeinstruction
This is a free document - should not be spread for money!

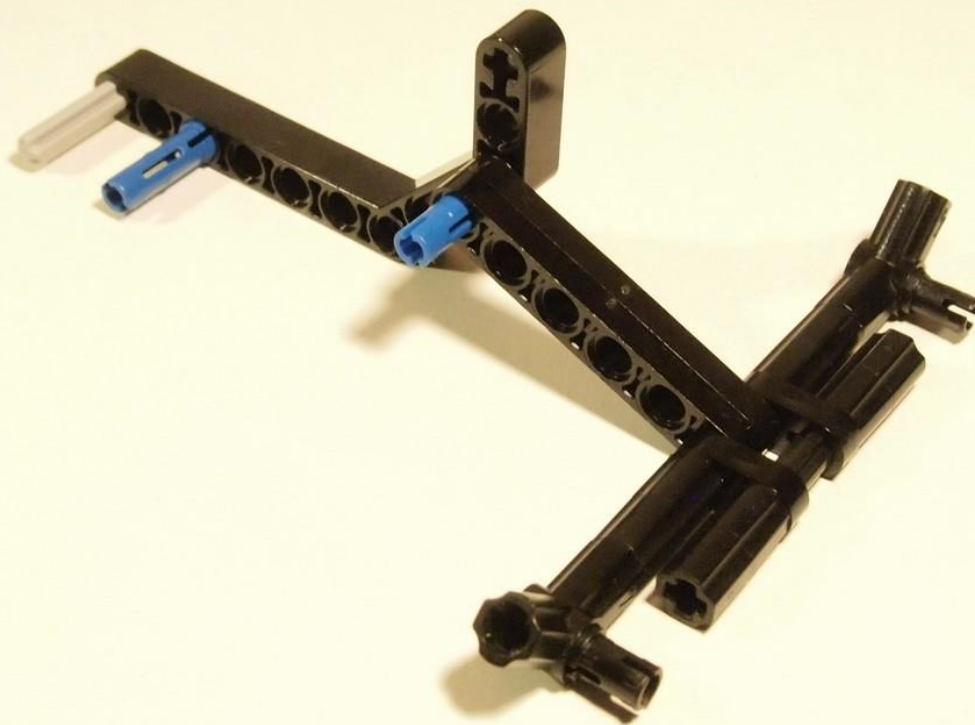



1x



1x

5



2x

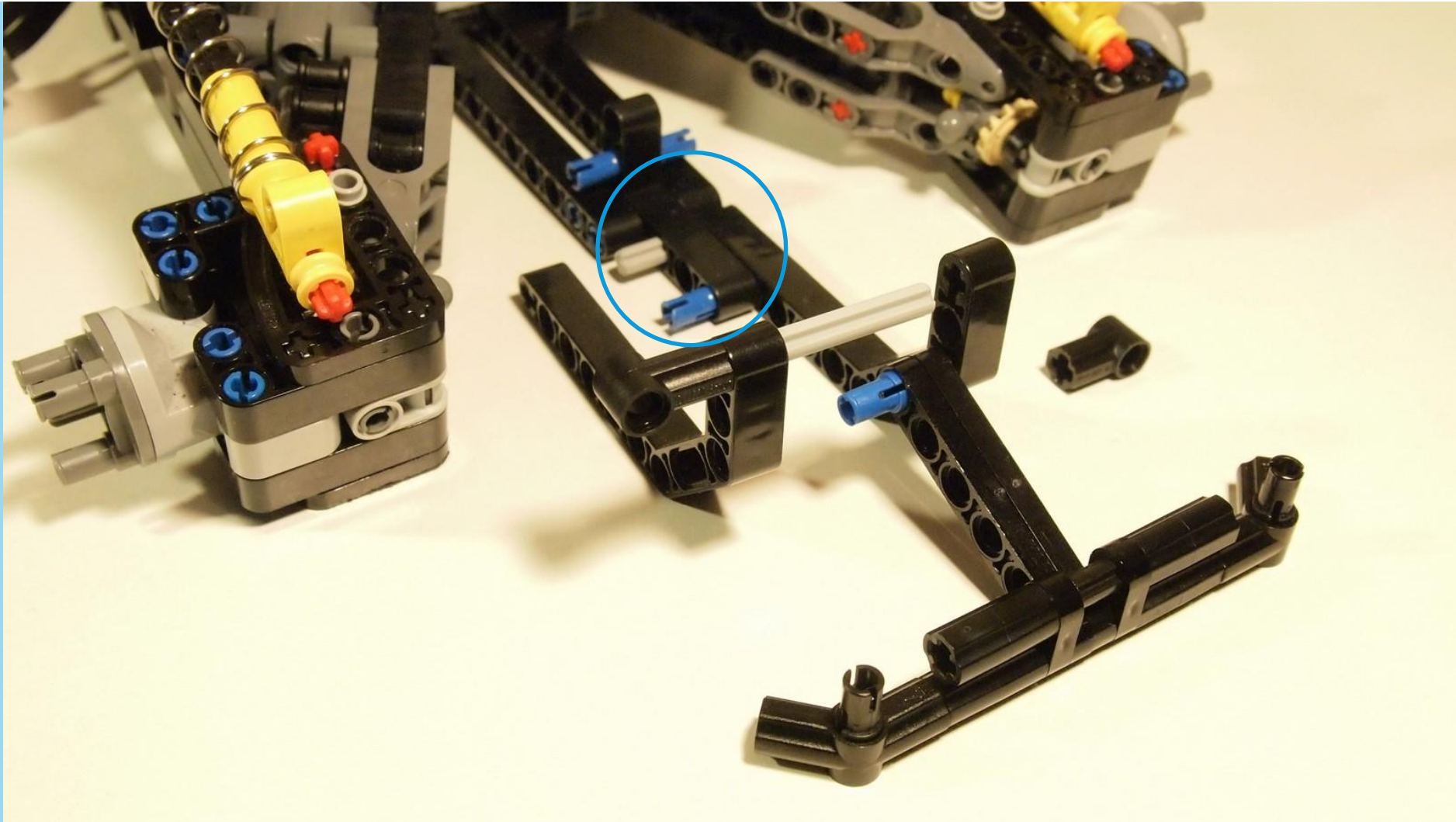

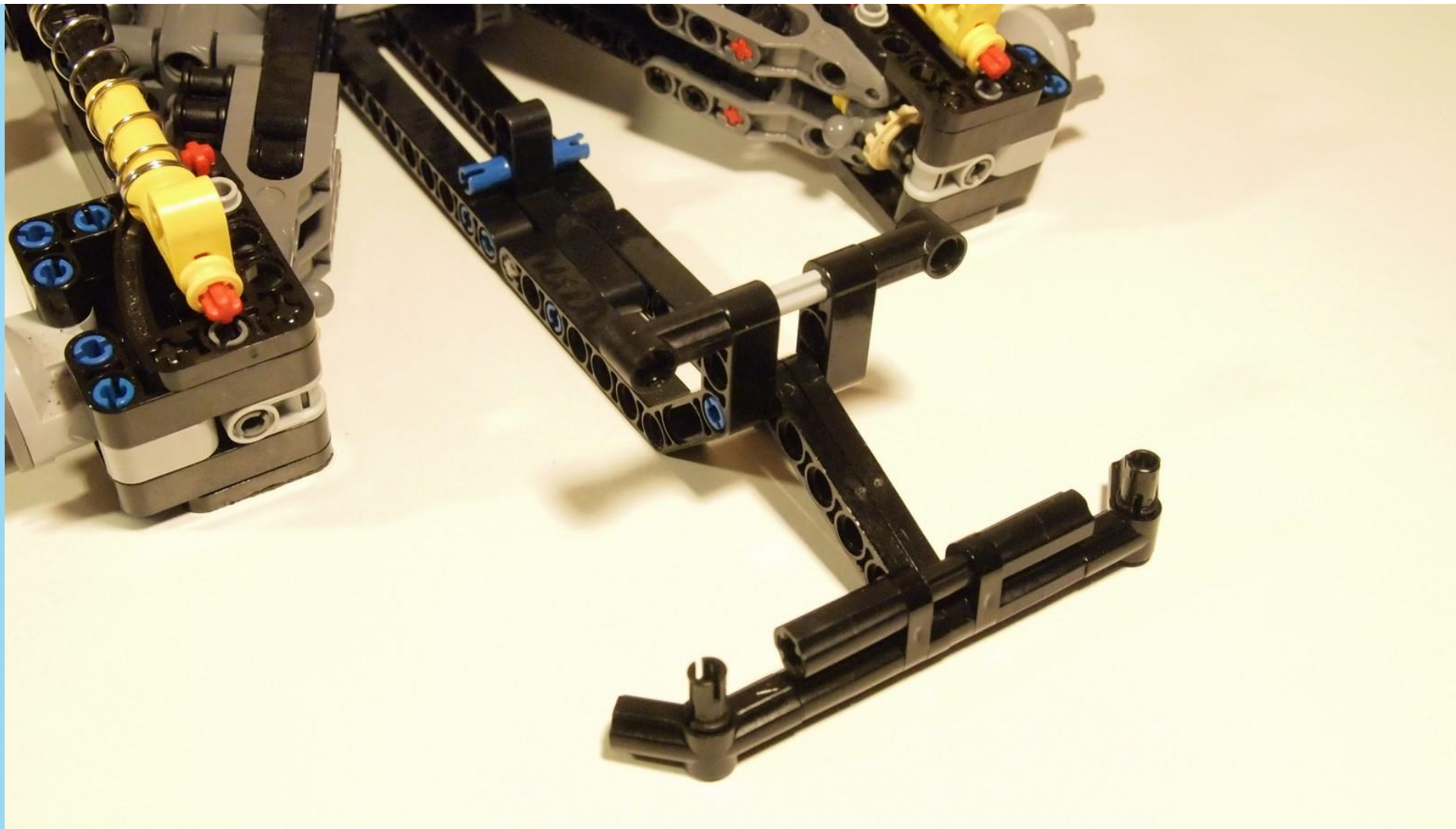



2x



2x



1x



1x



85 mm

2x



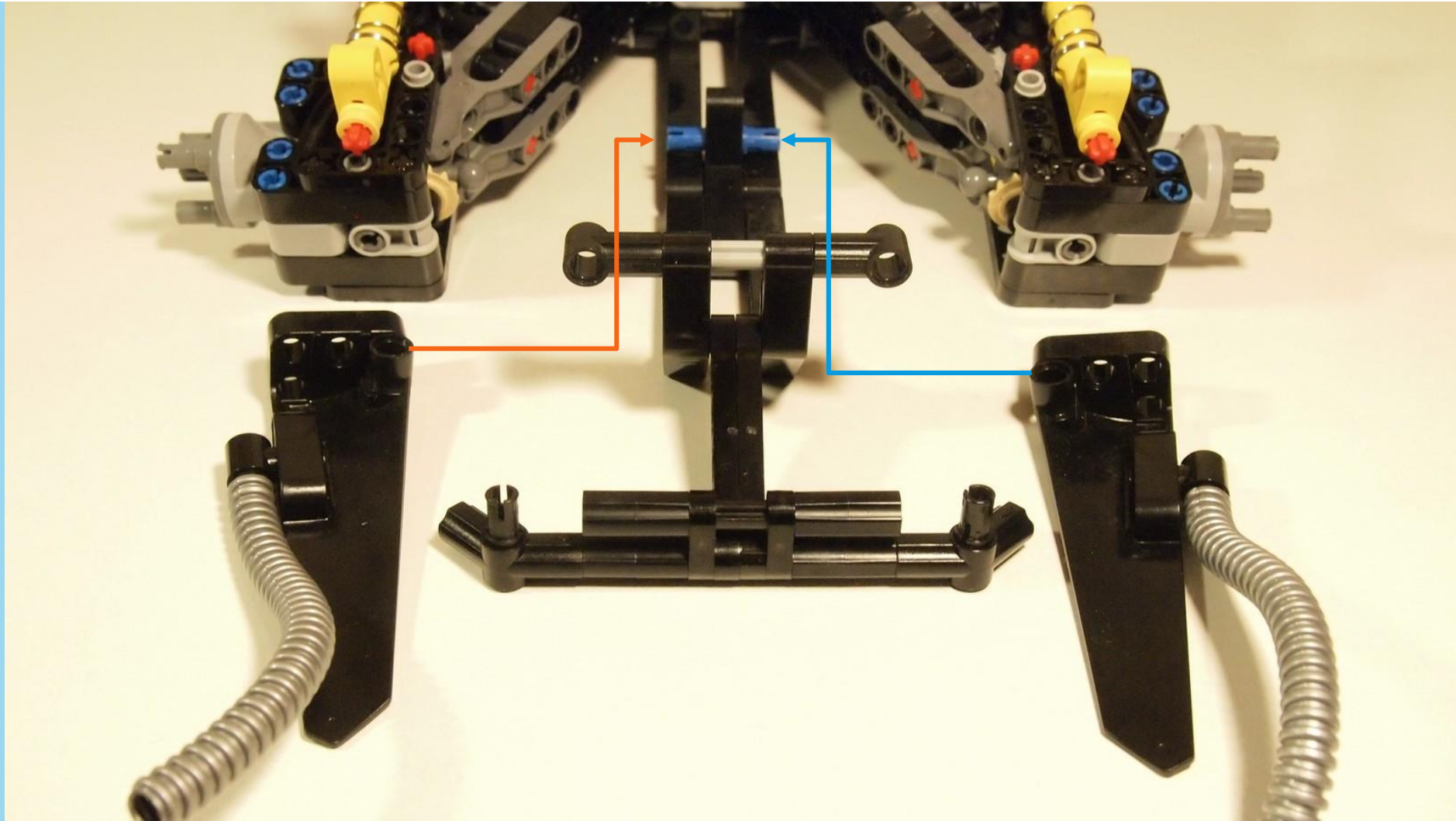

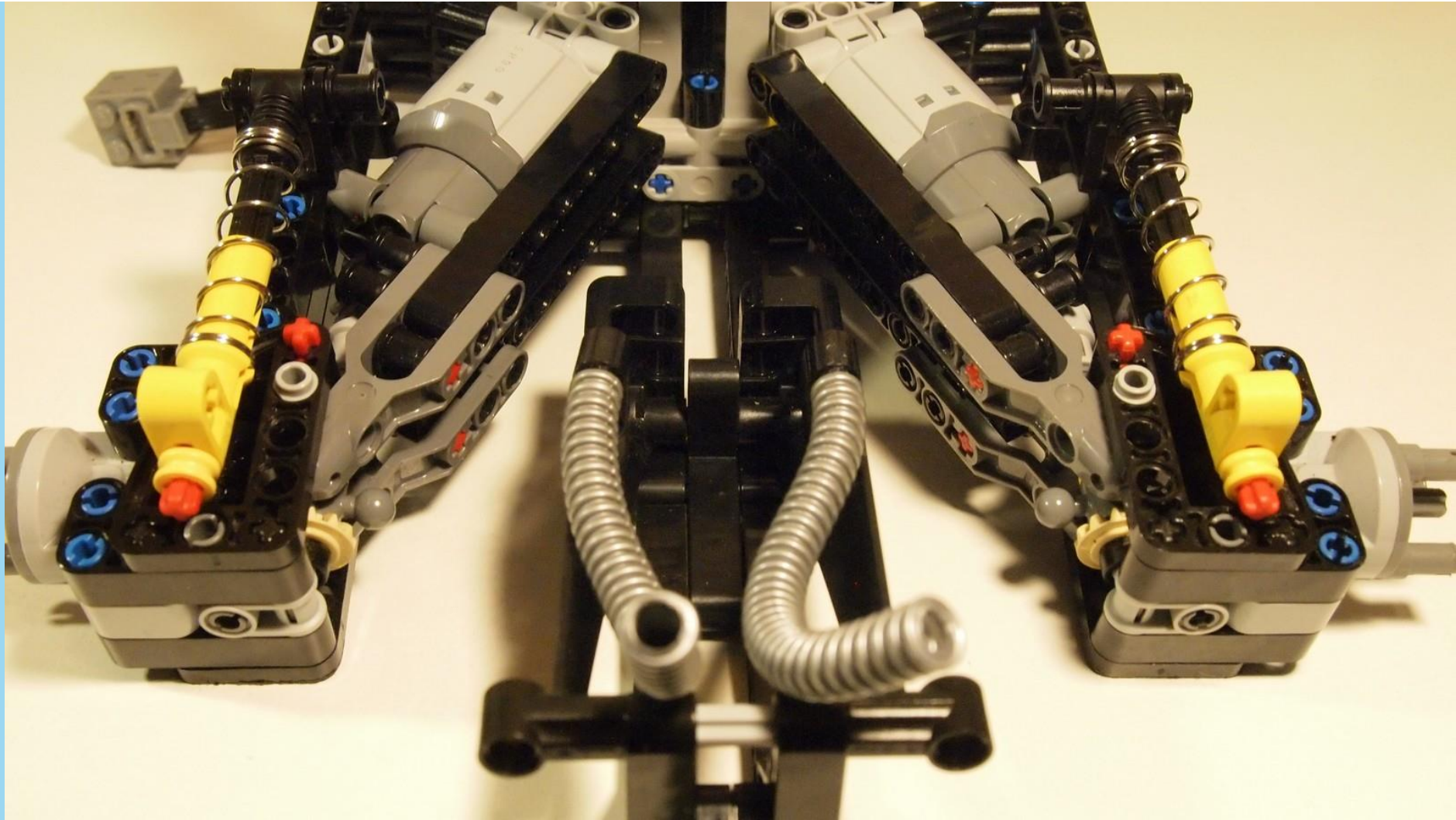



4x



4x



2x



1x



1x

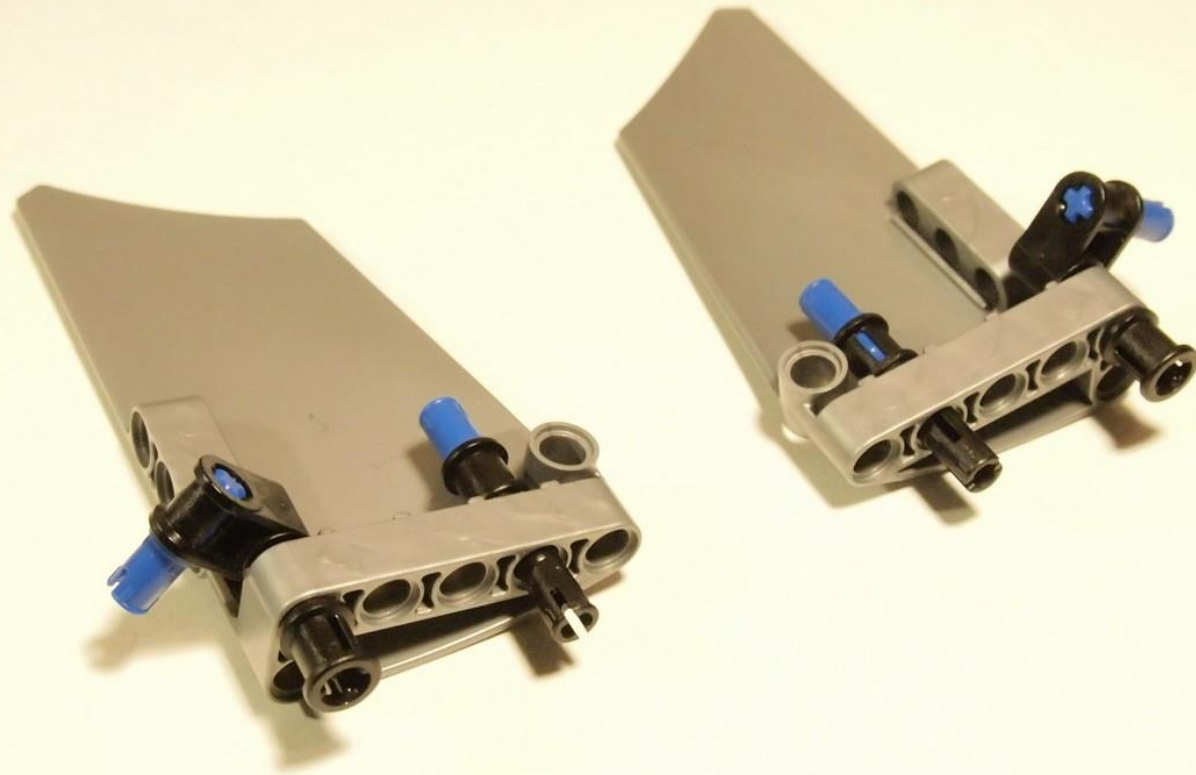

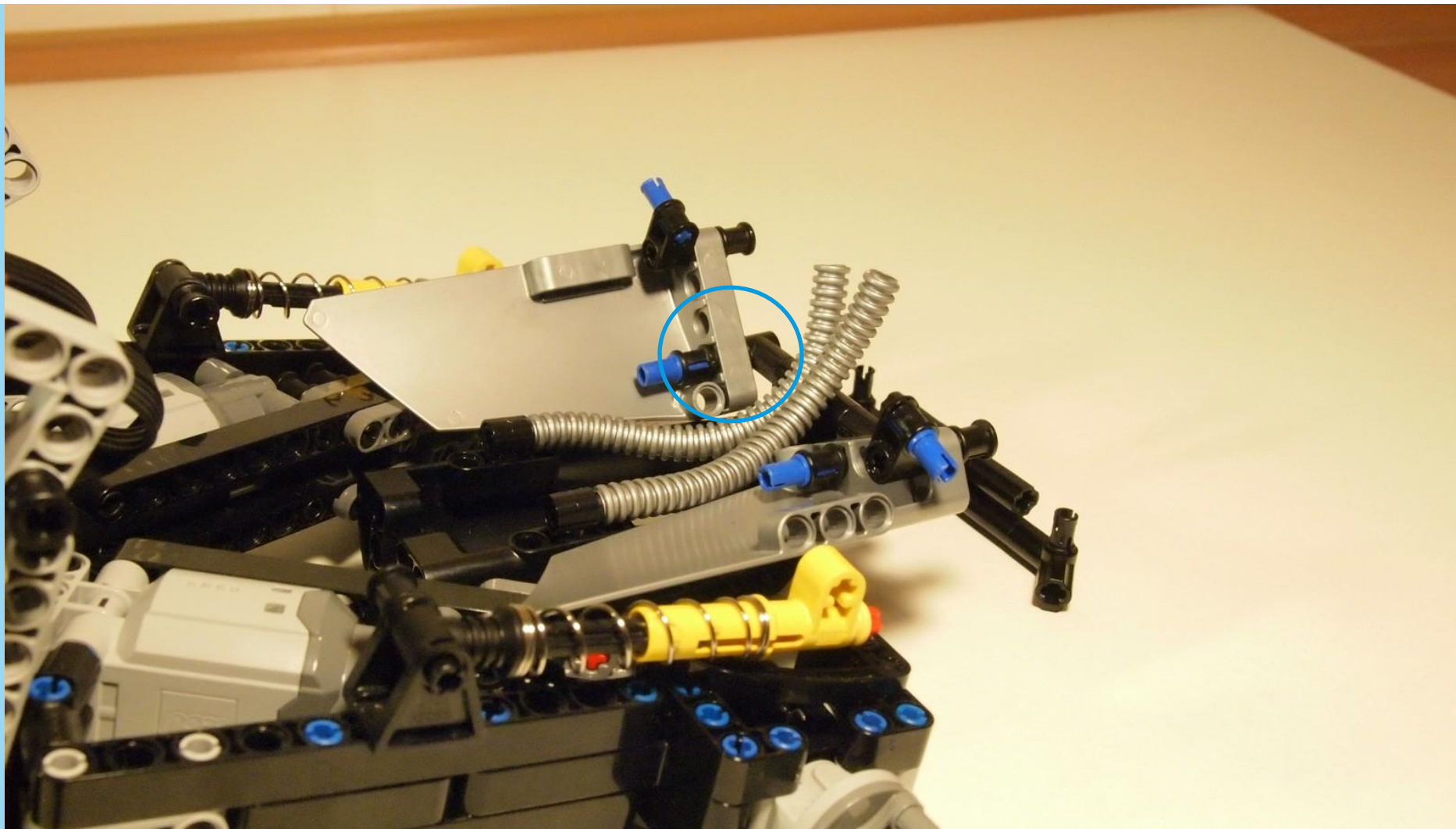

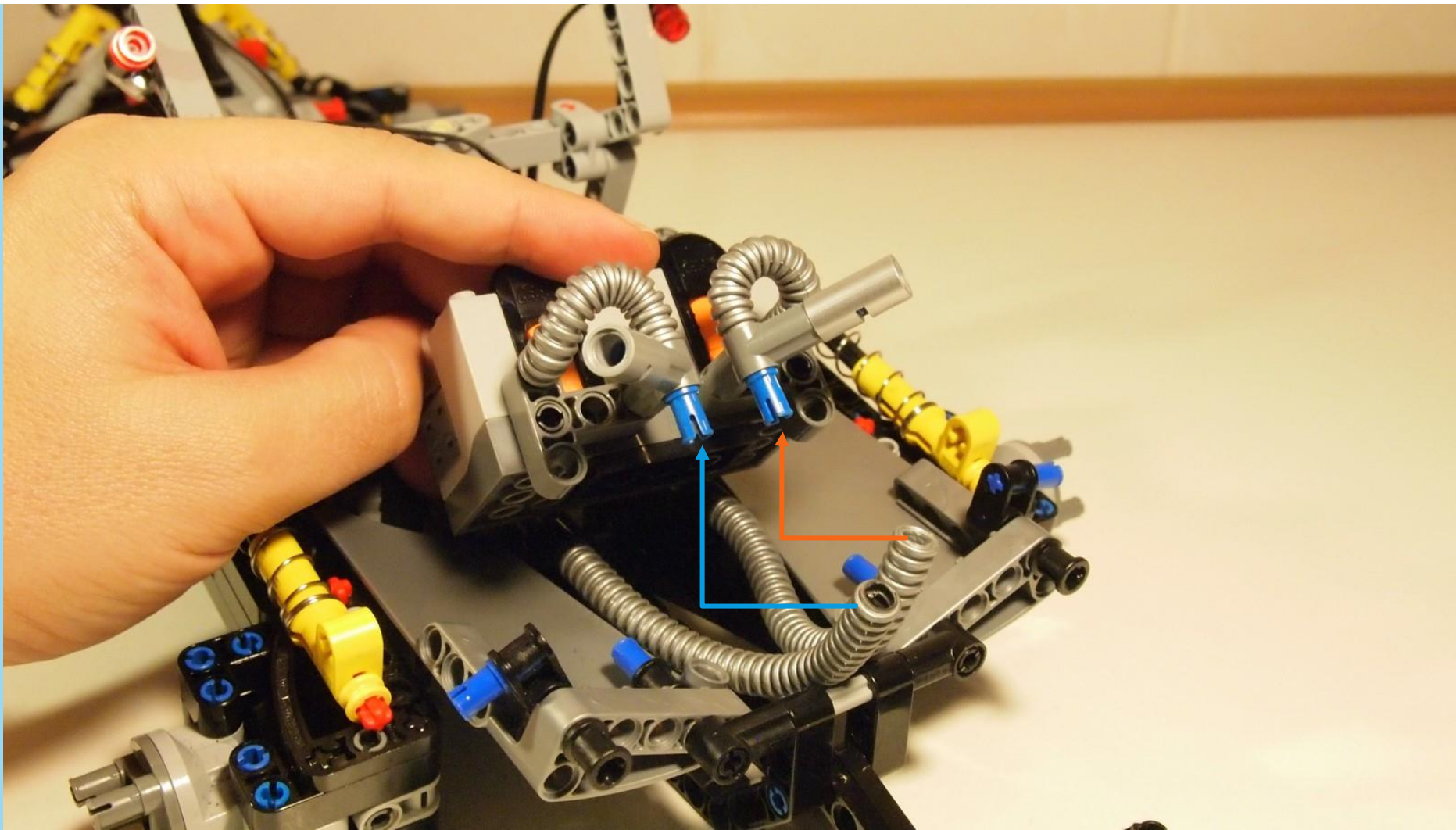

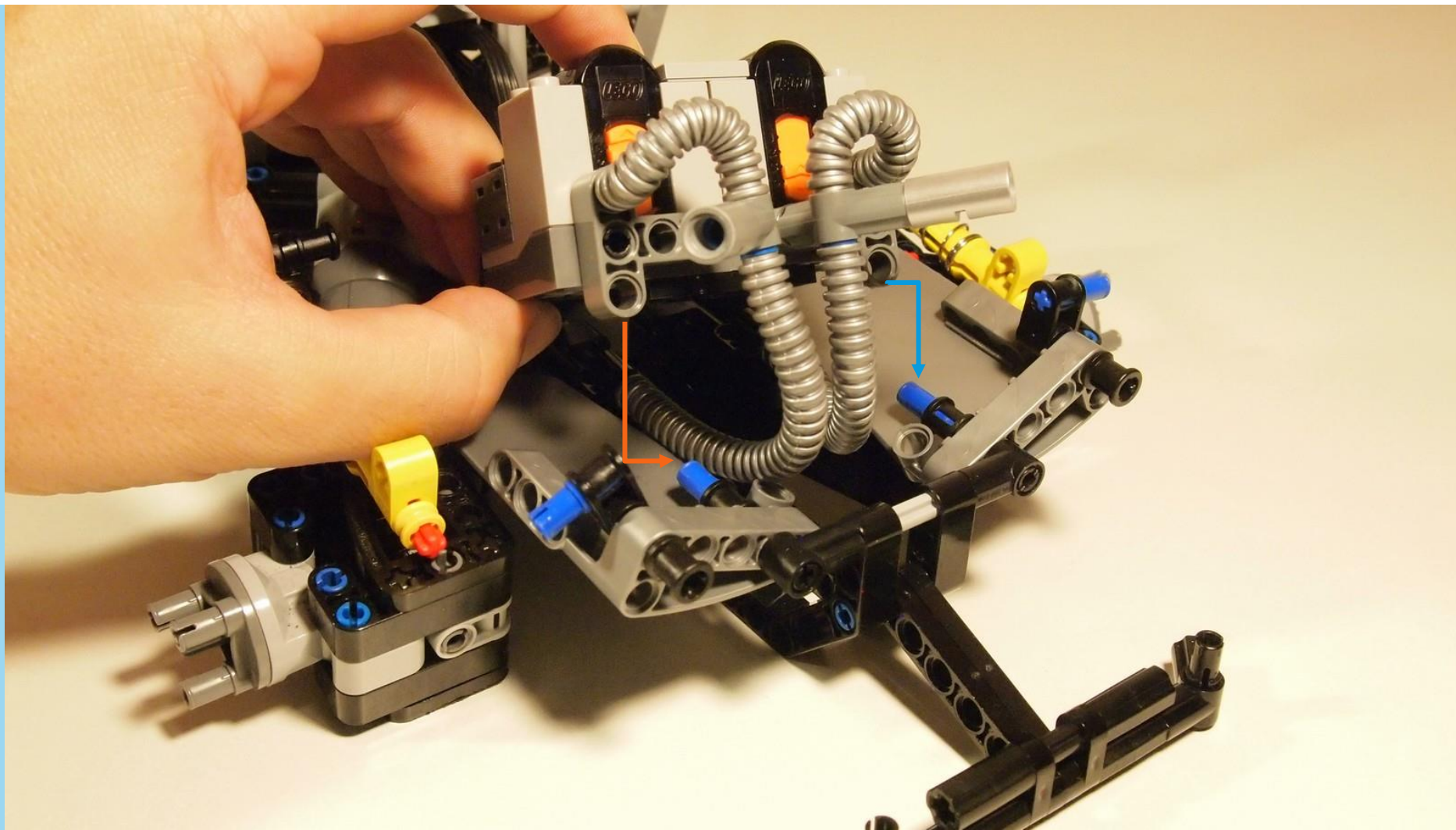



Check the bottom exhaust tubes, they must run symmetrical!

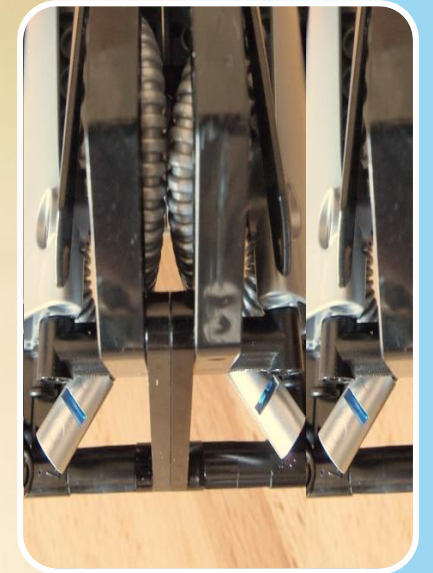
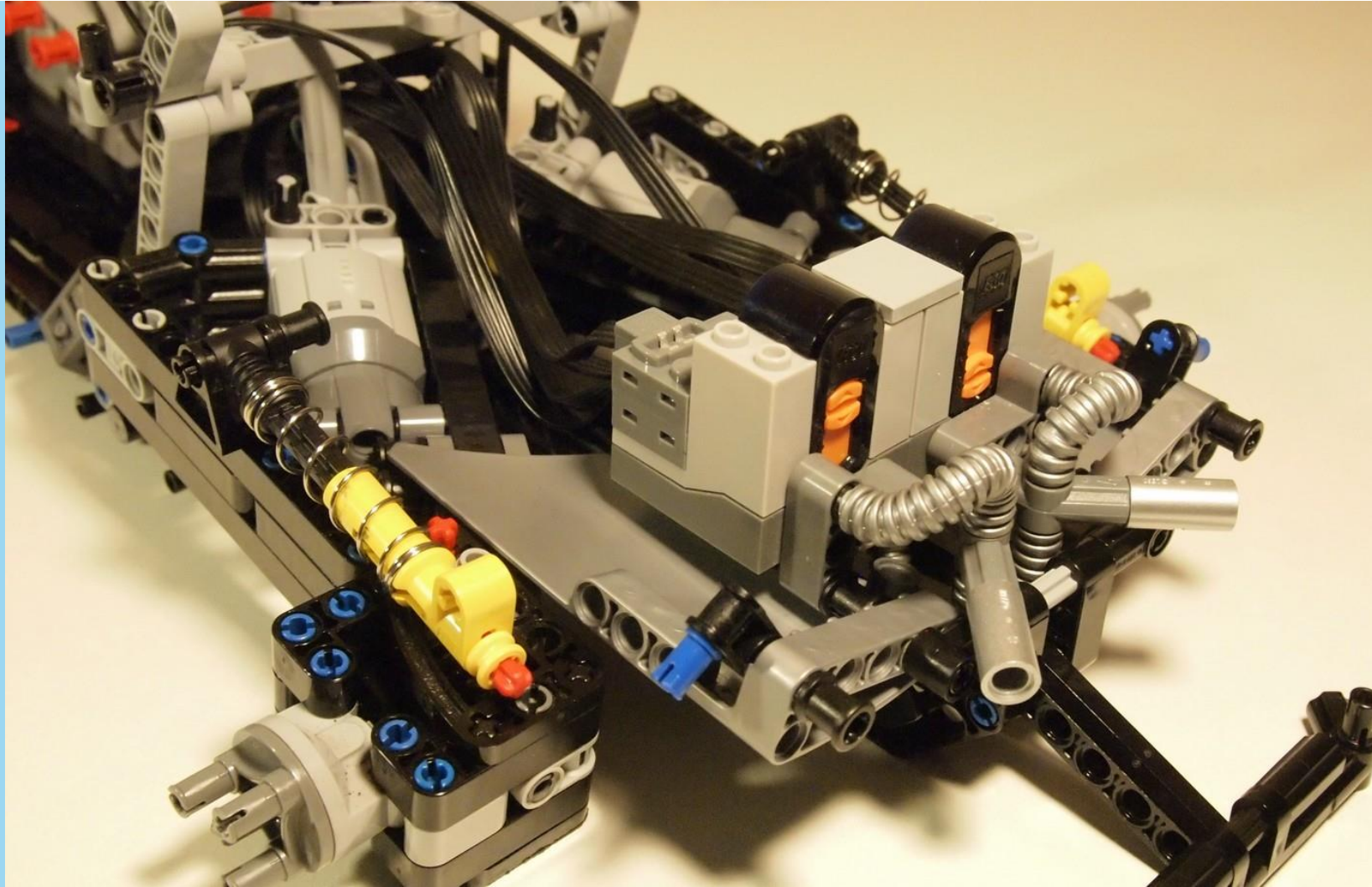

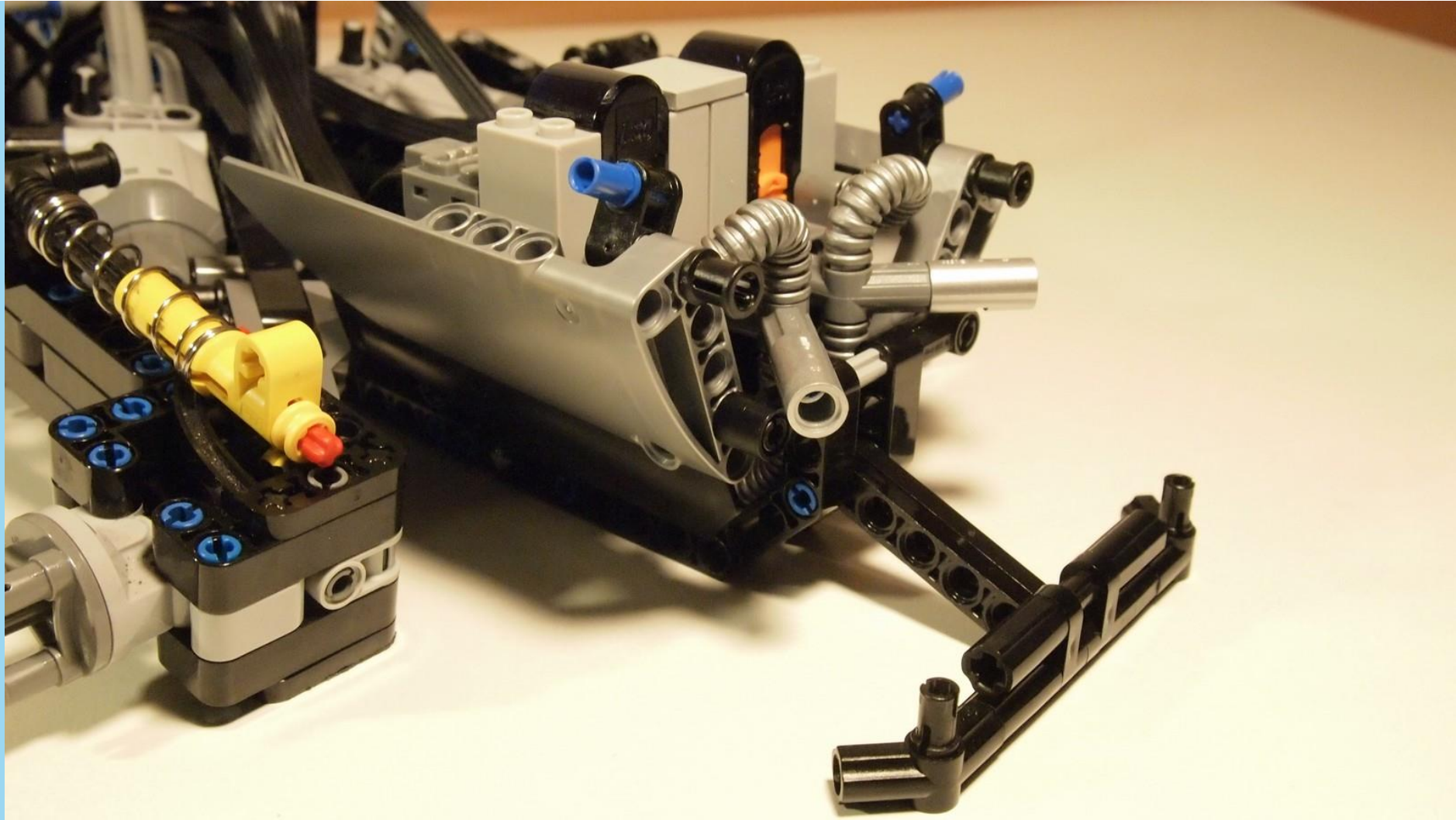

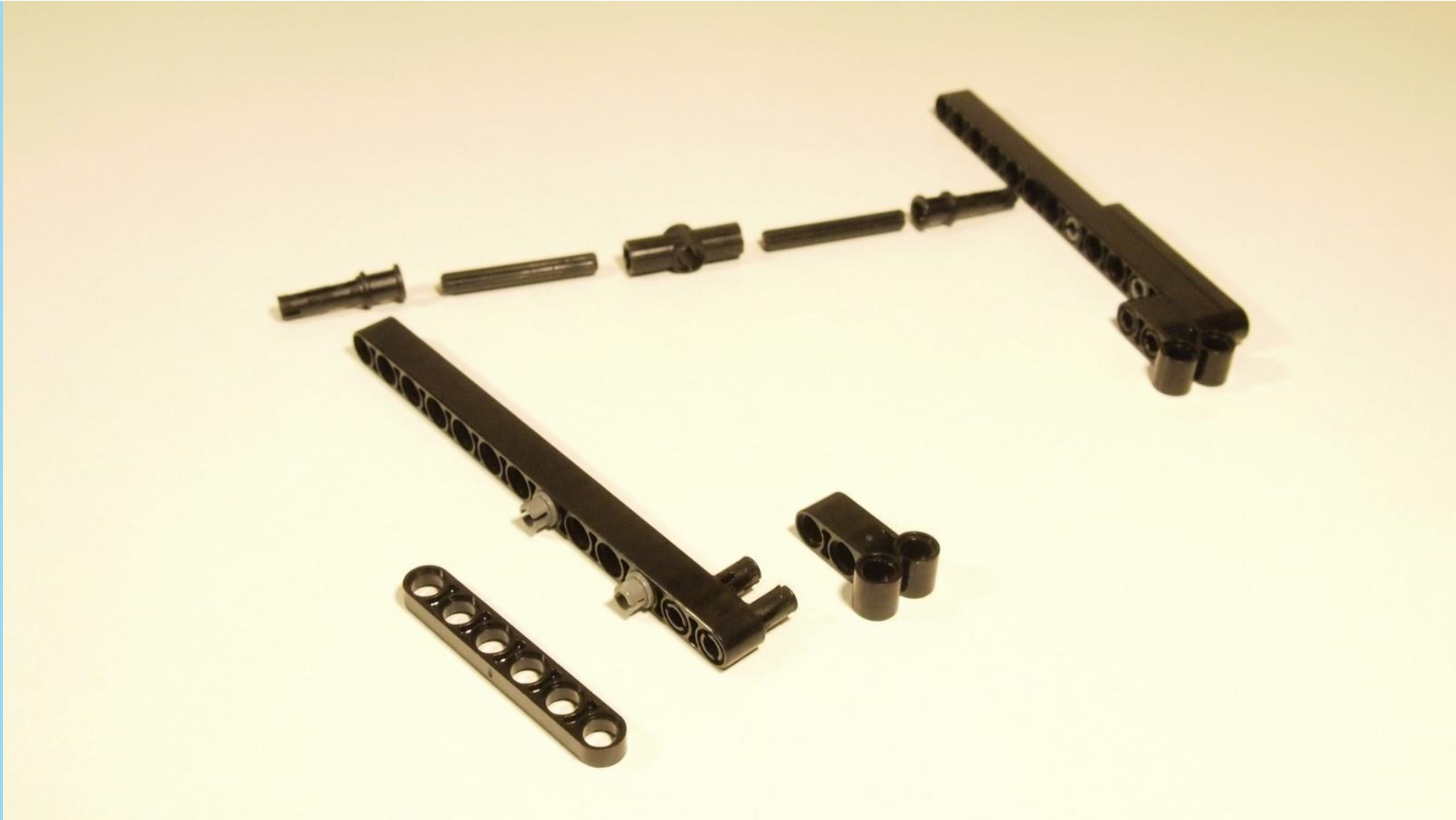
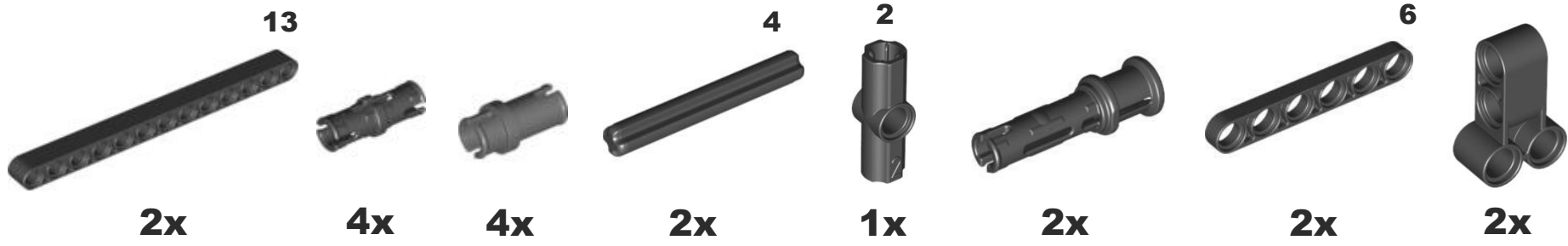

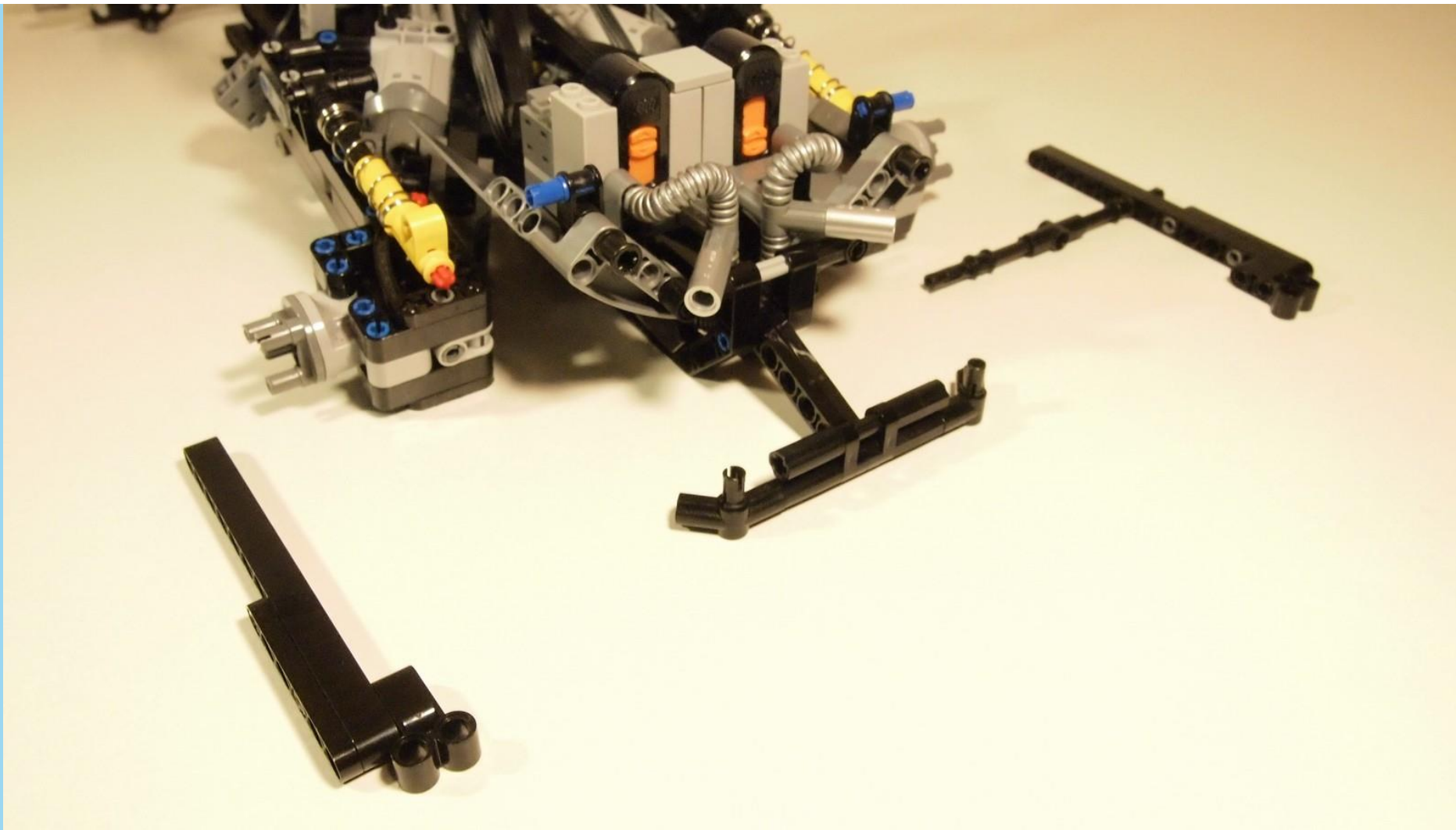

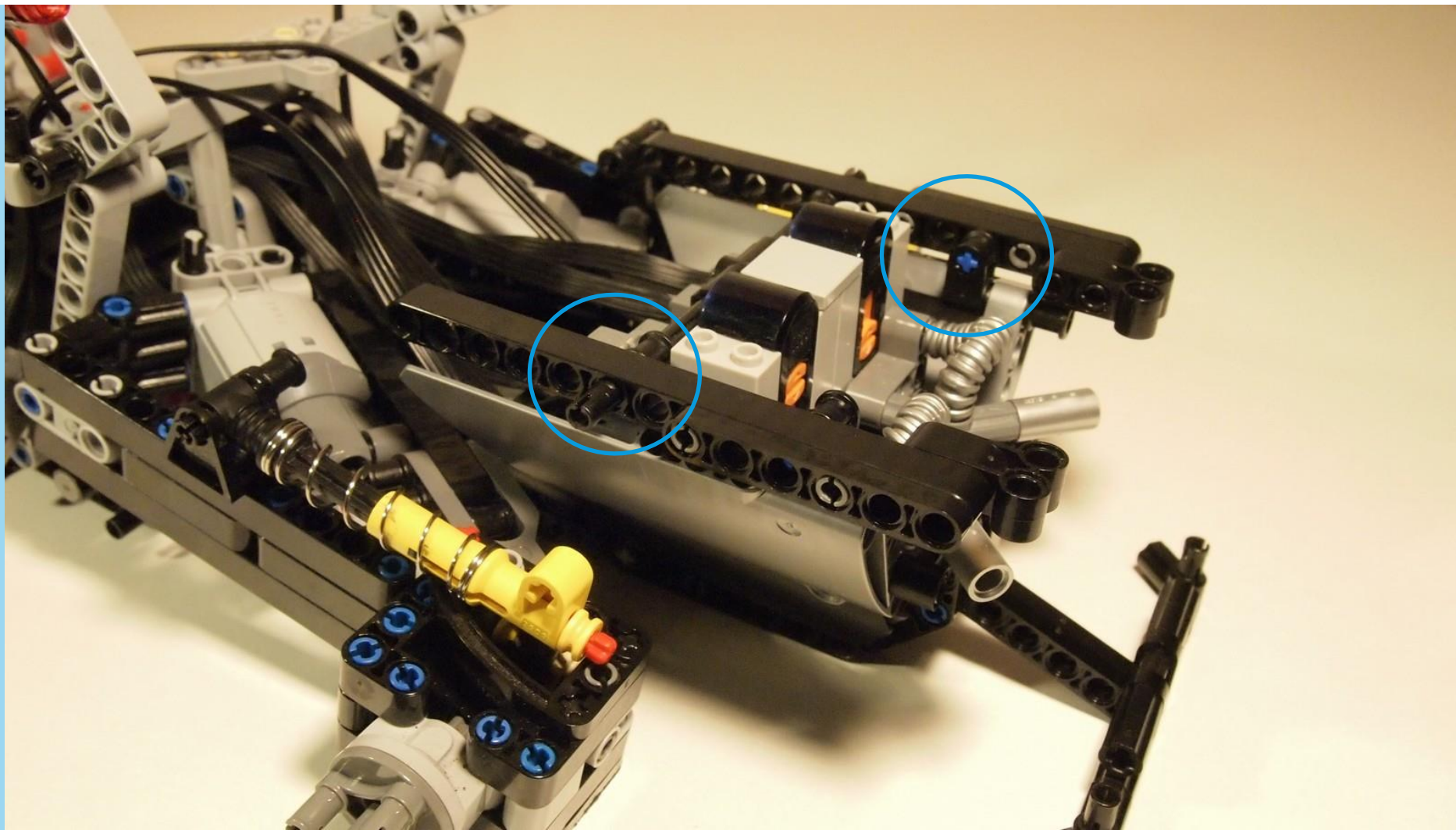

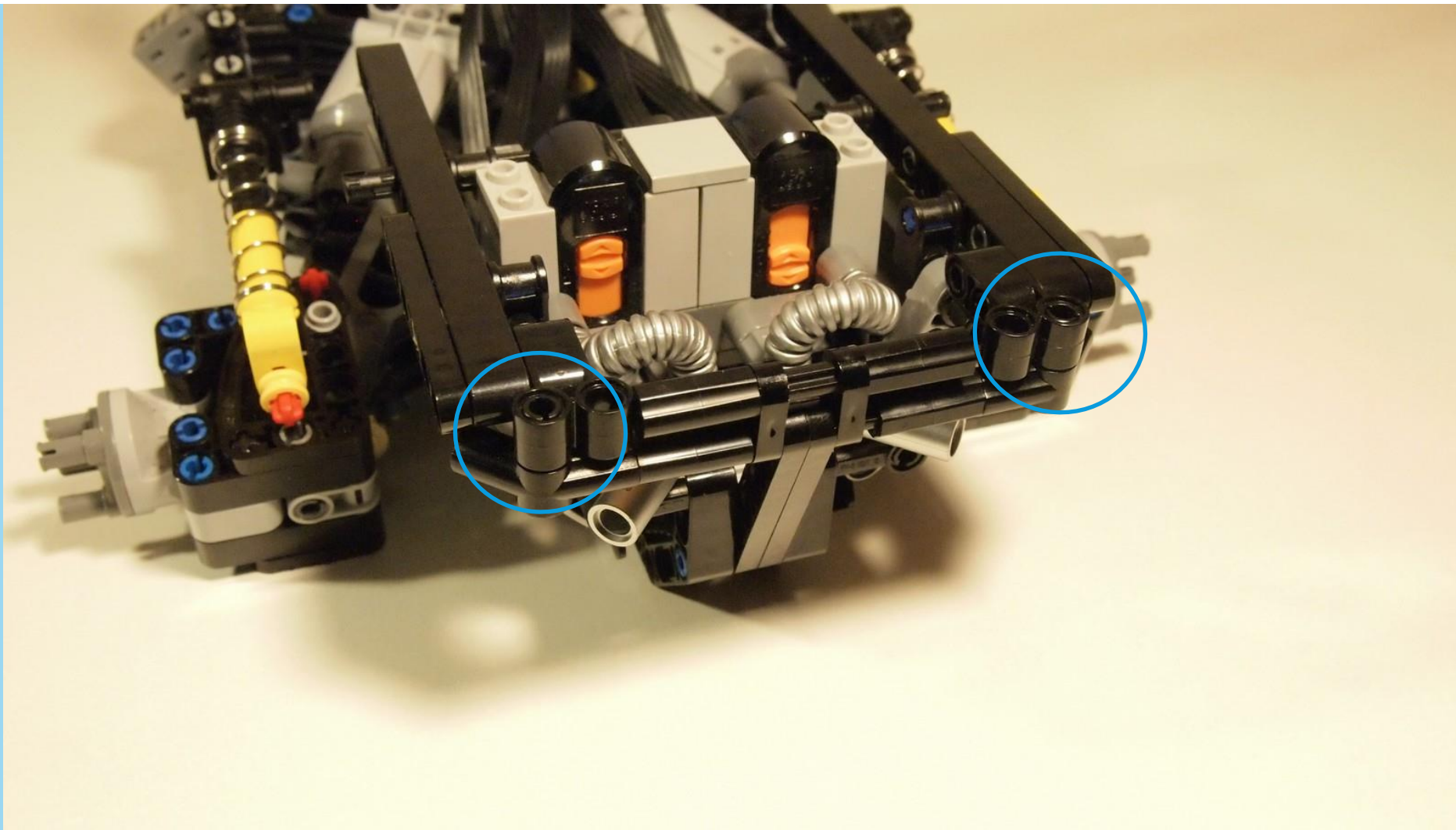



3x



2x



1x

2



2x



1x

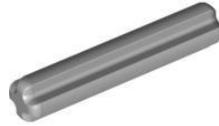

1x

3



1x

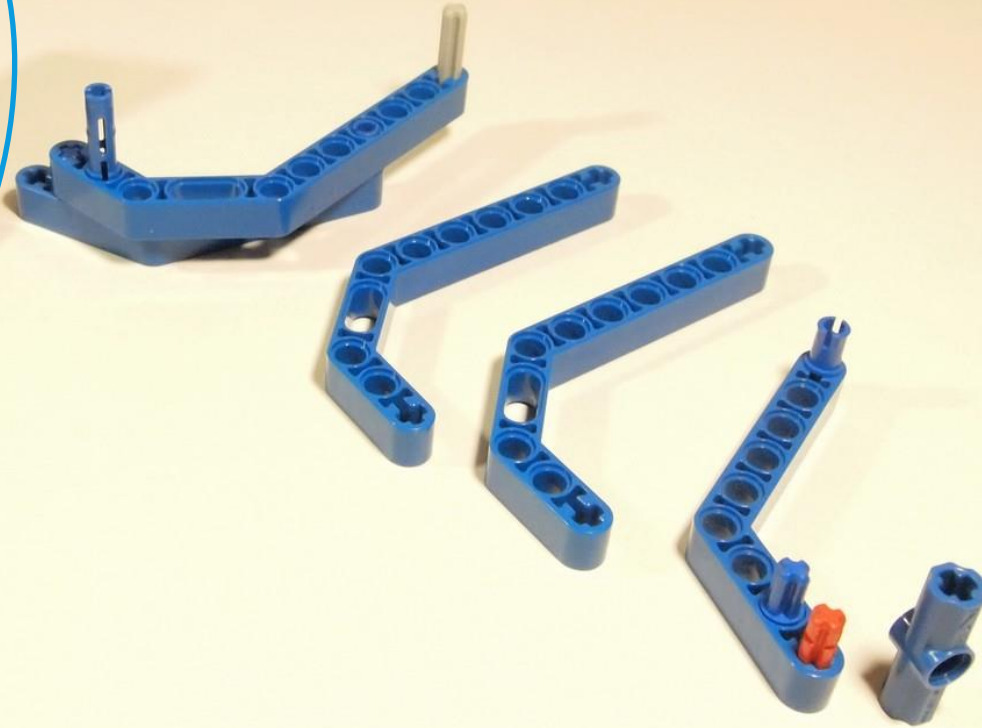
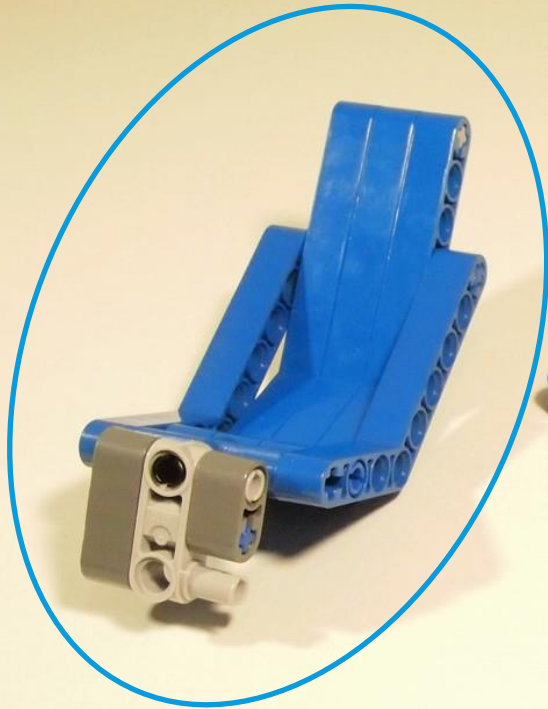

x2

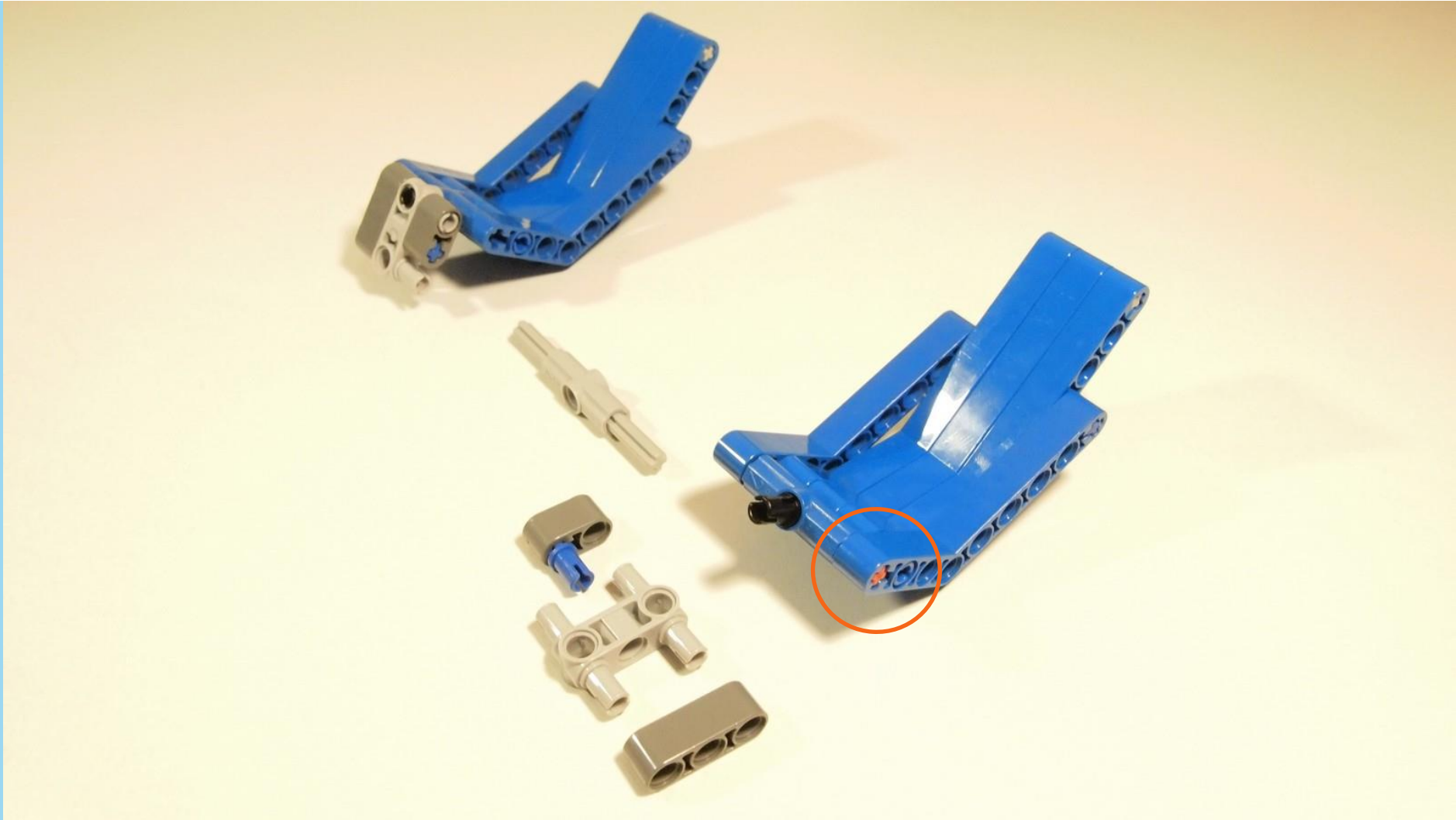

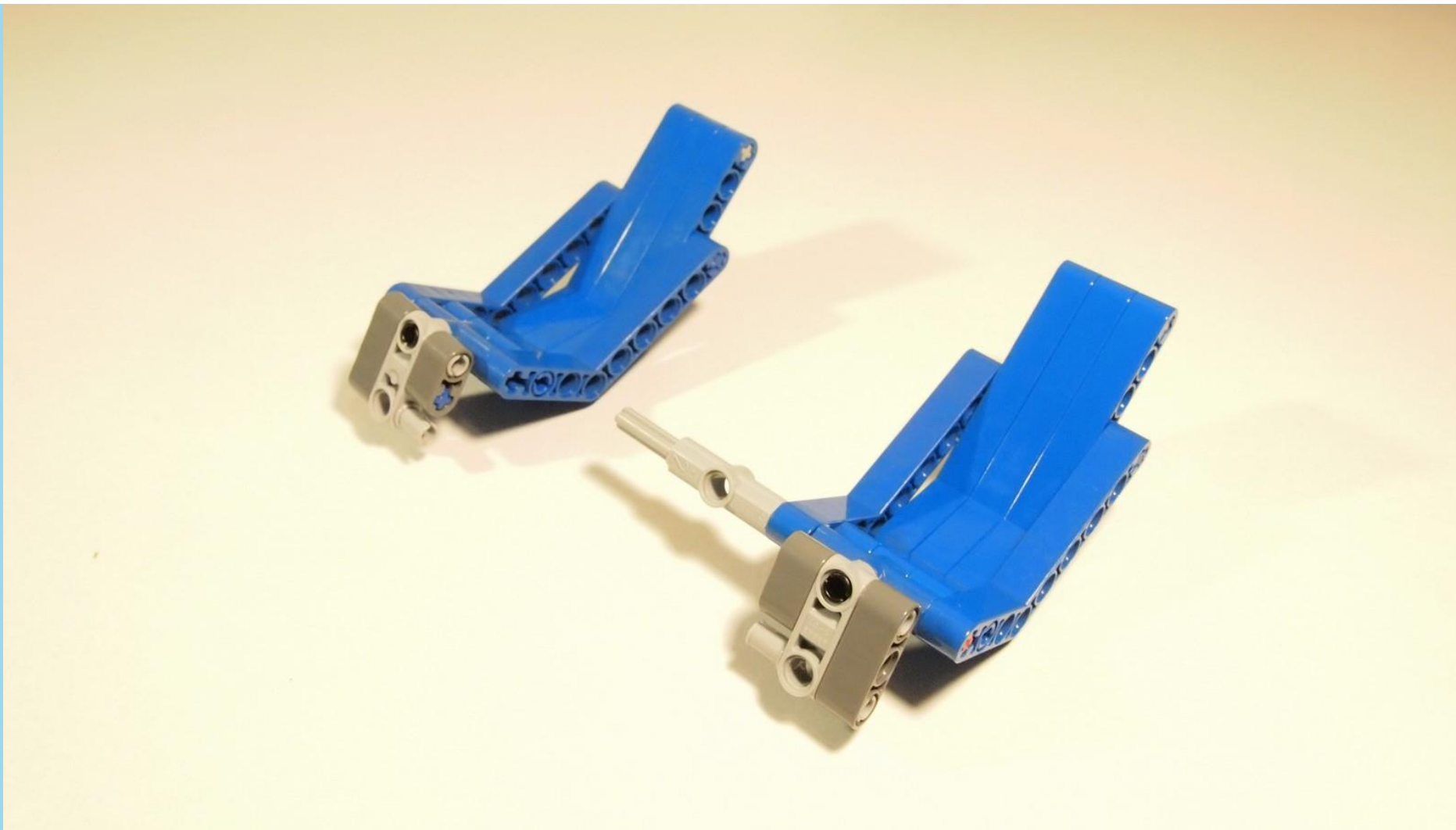



Check the wire's path!

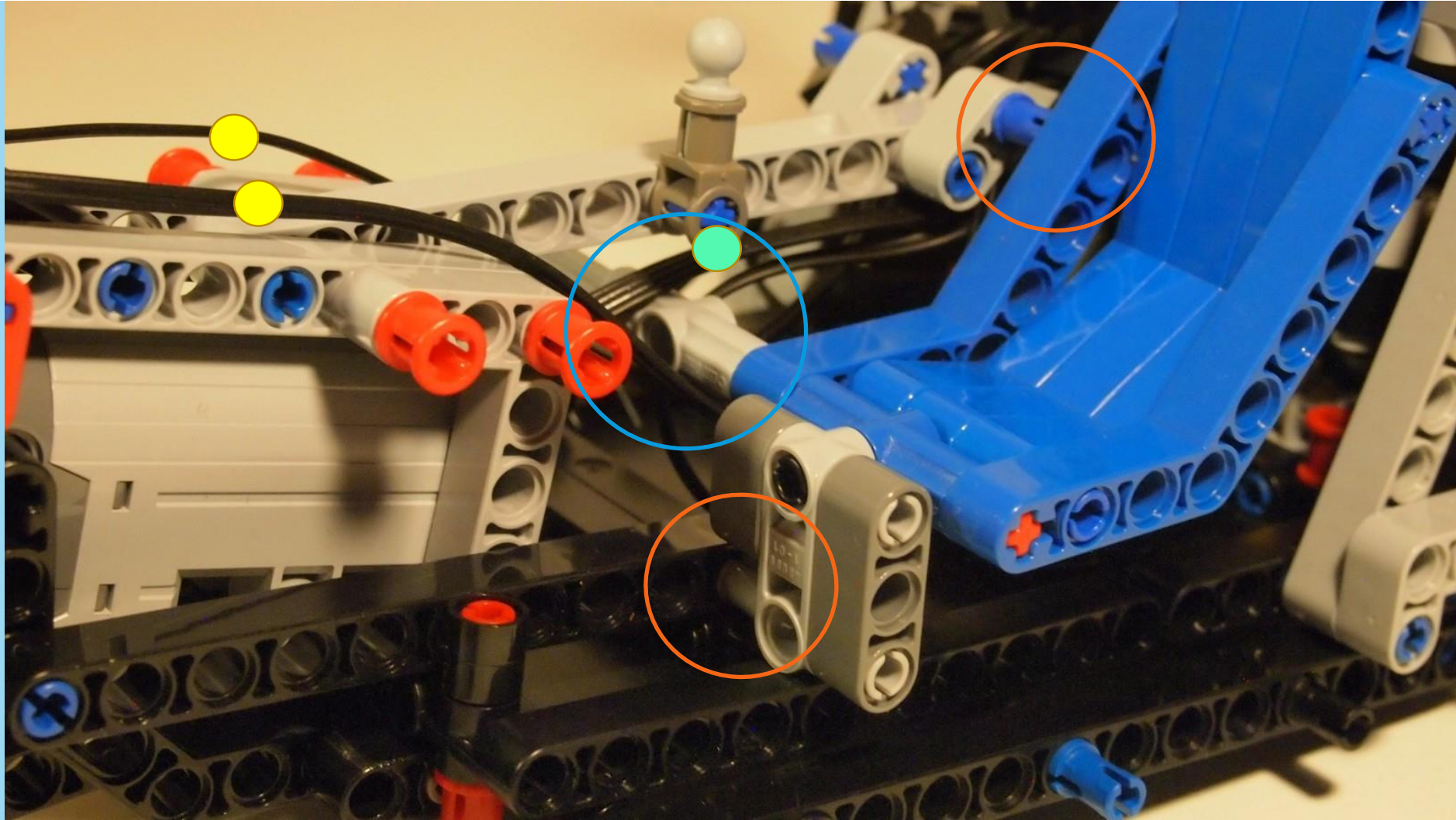

● front led

● servo

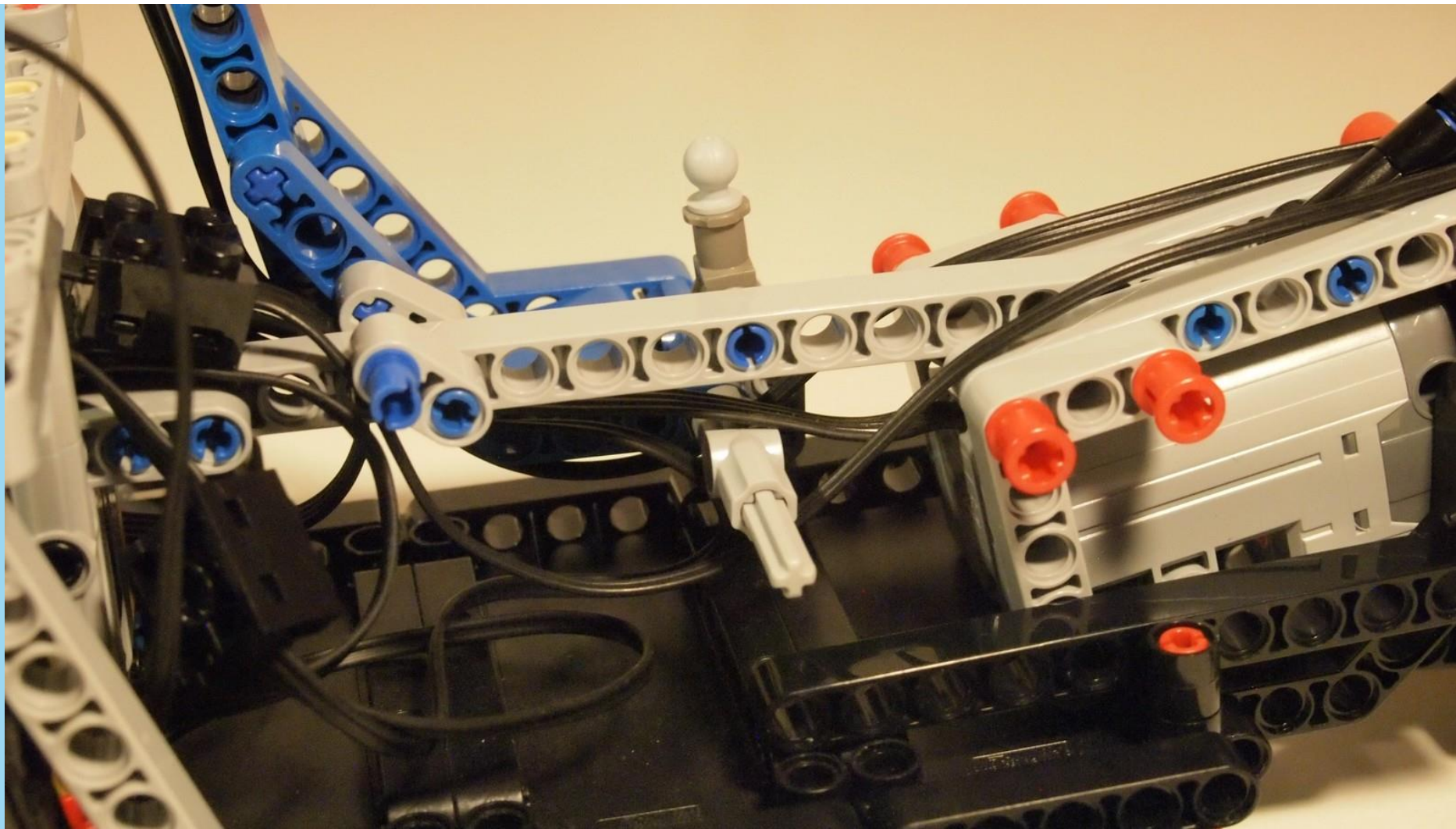

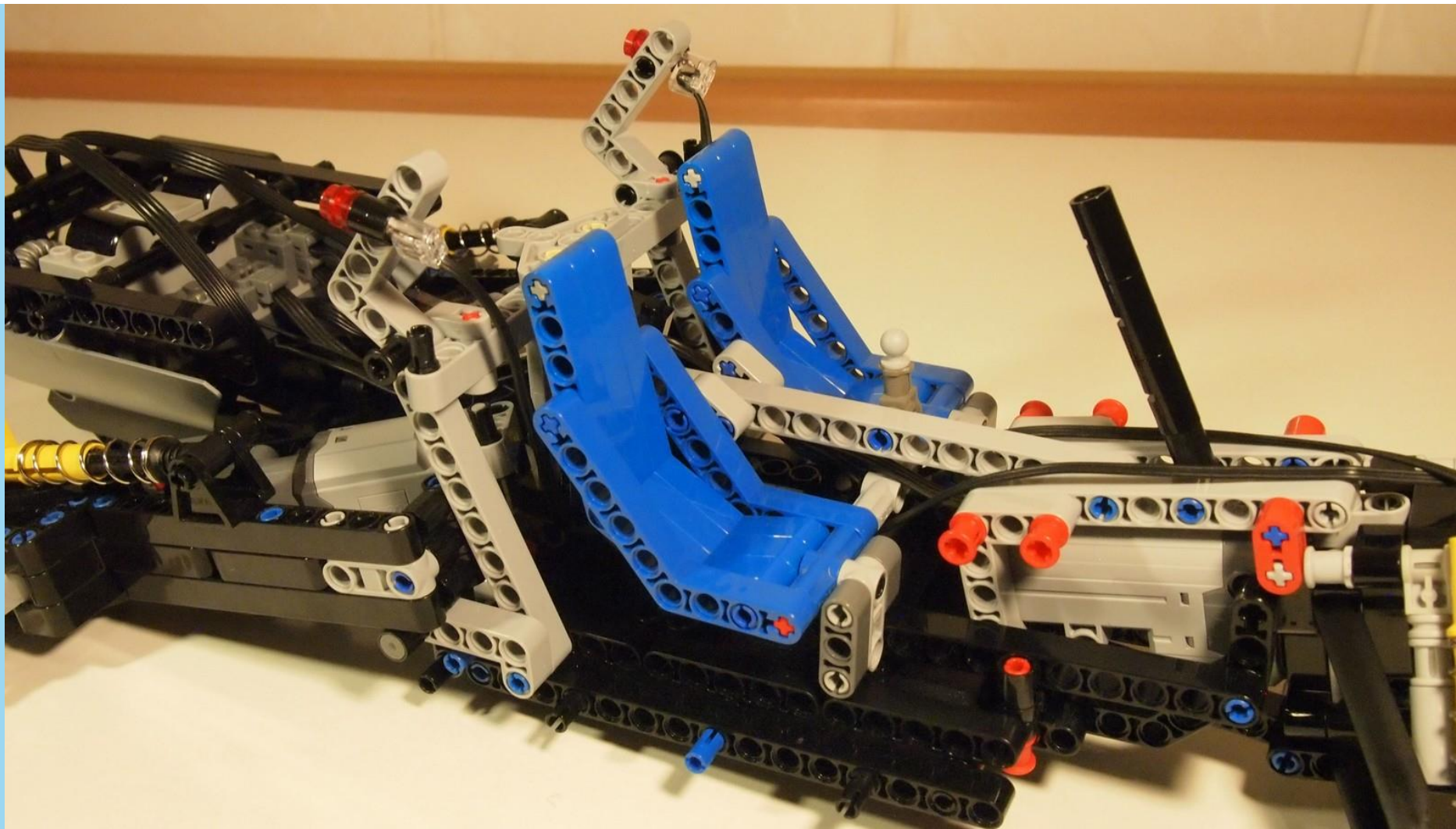



I will show you how to build the **left** side, build mirrored the **right** side!

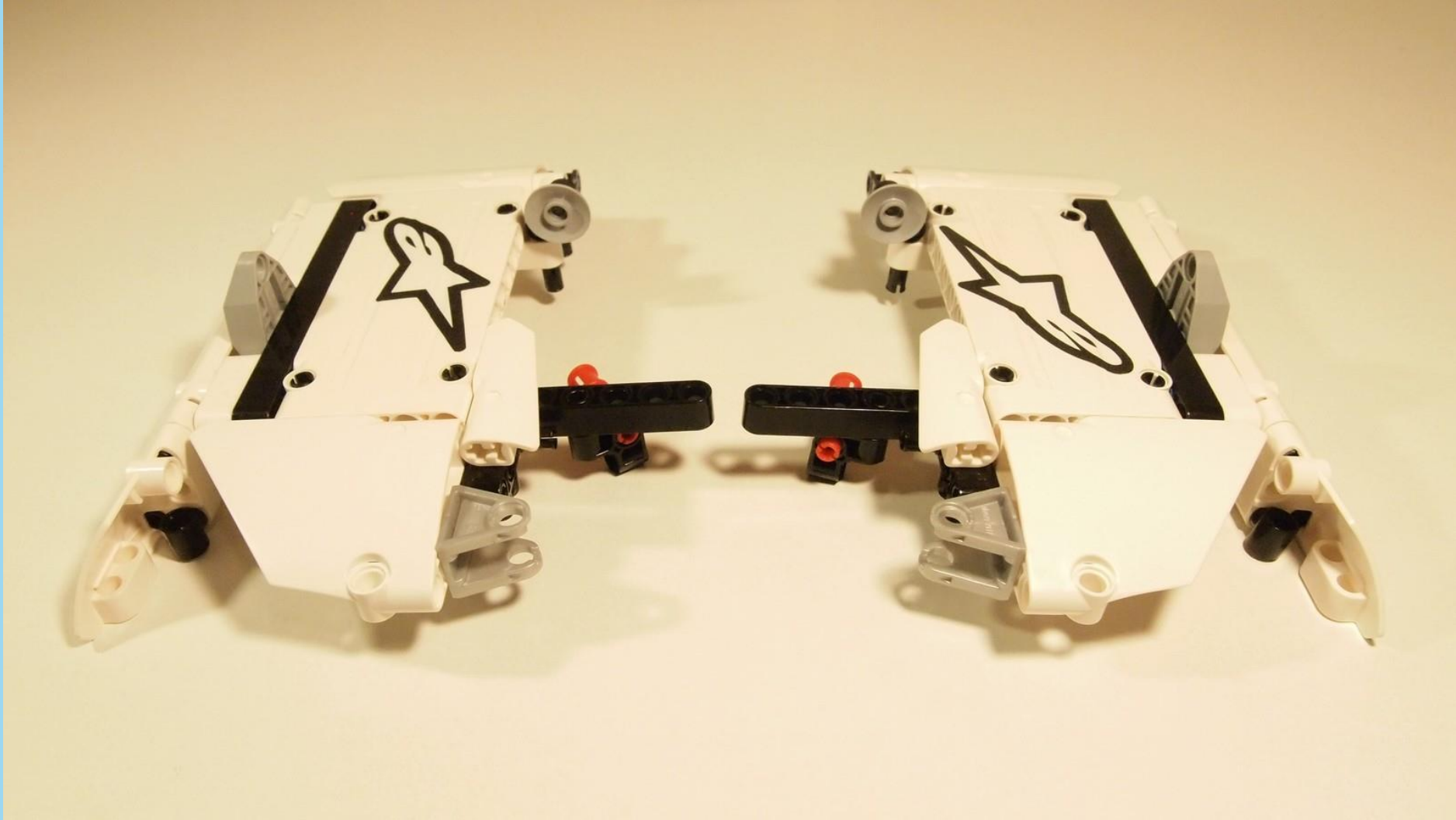



1x



1x



1x



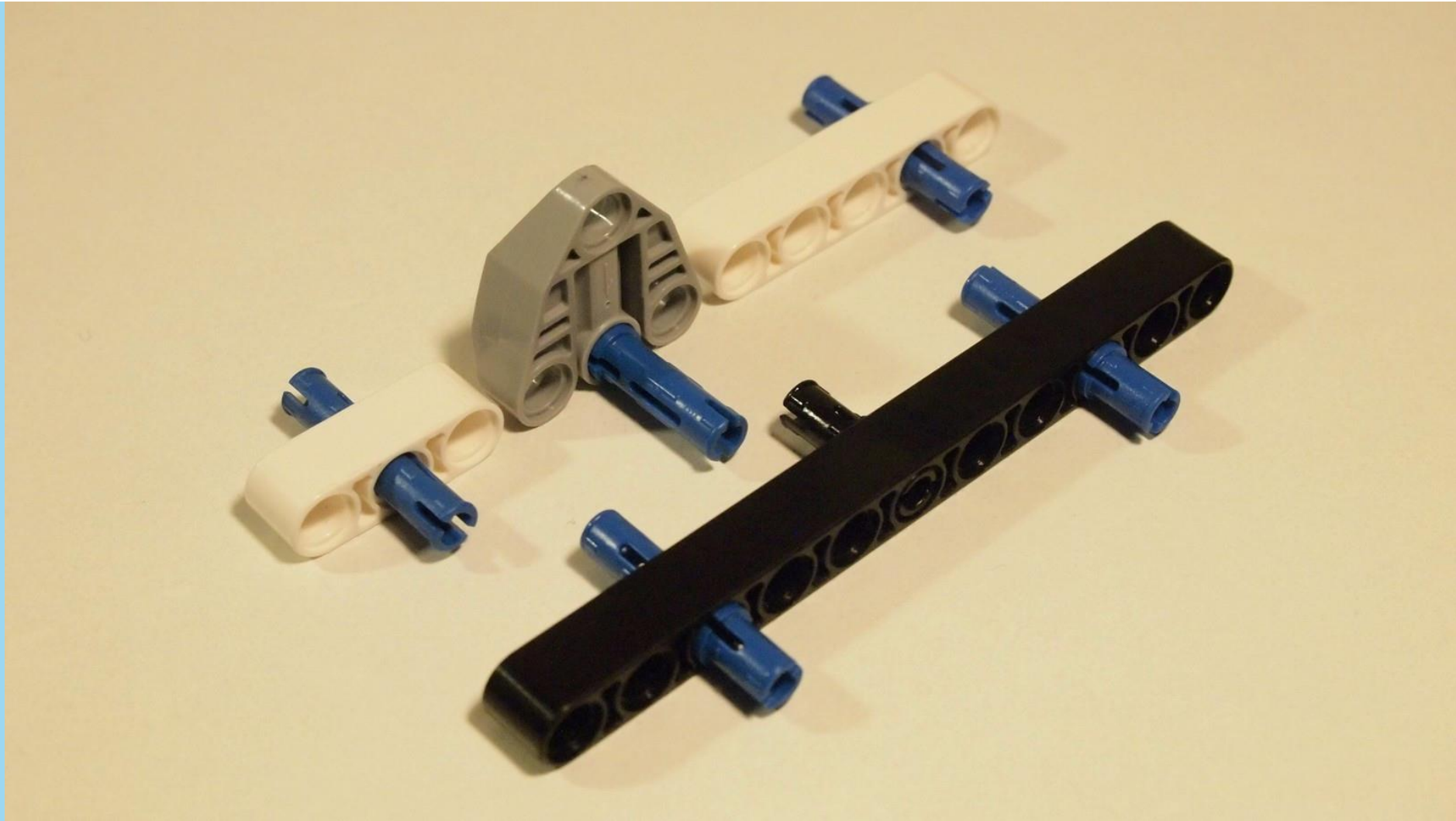
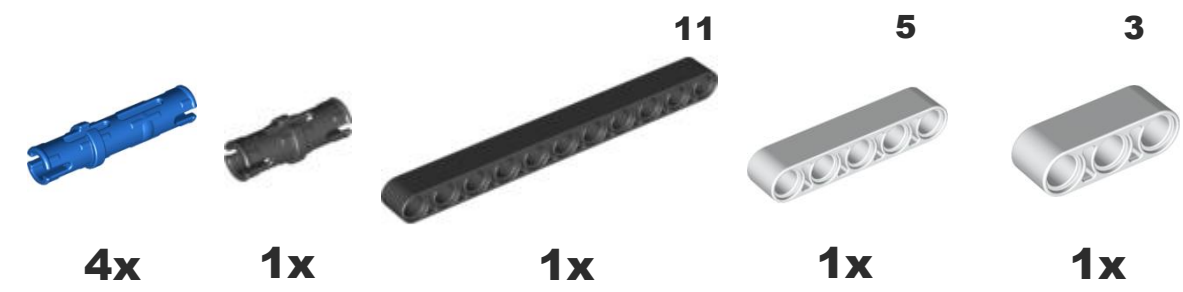



1x



1x



1x



1x

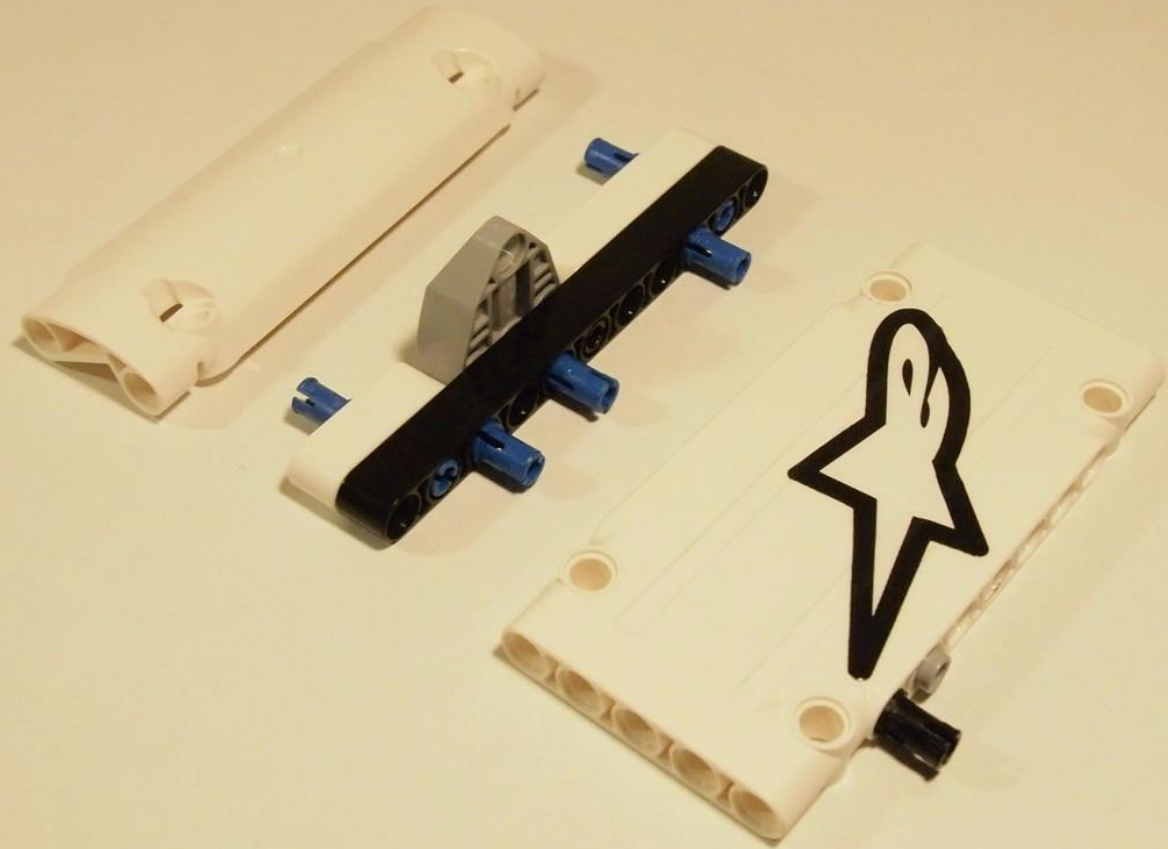

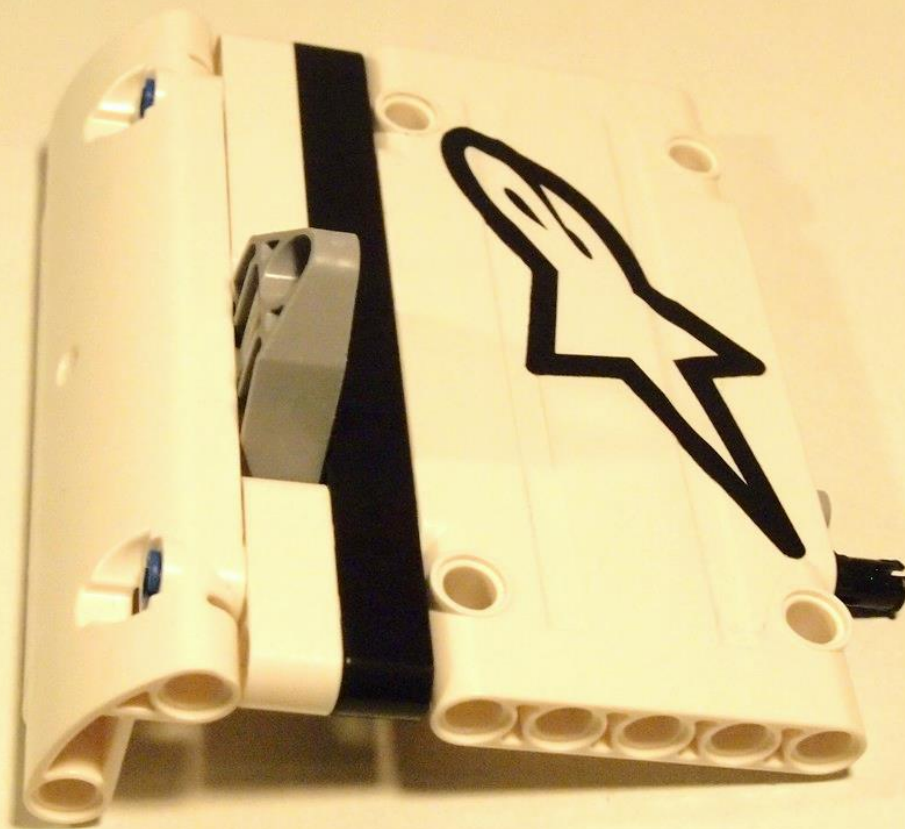



4x



2x



1x



1x



1x



1x

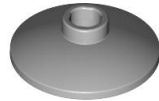

1x



Use this for the **right** side!

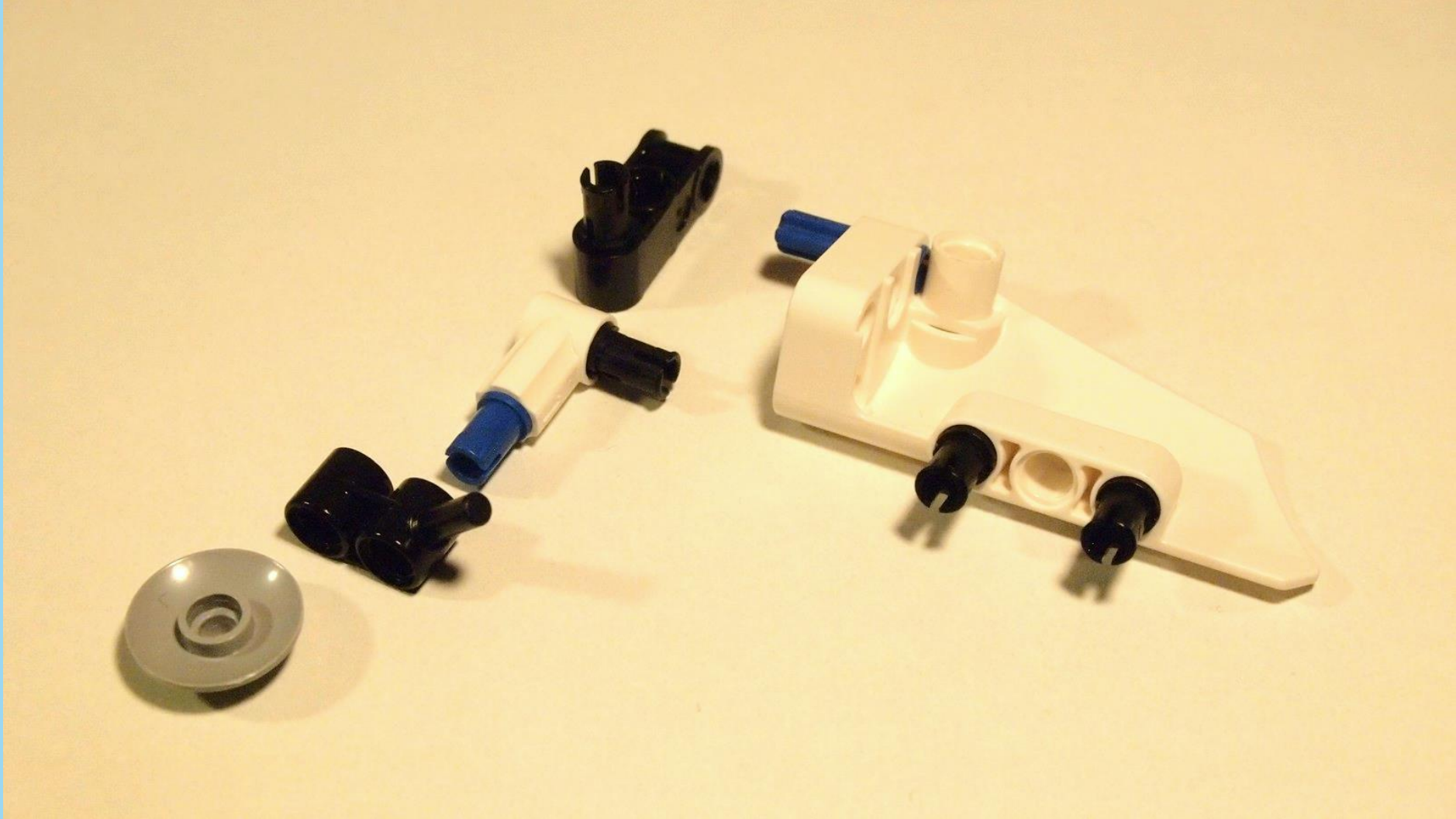

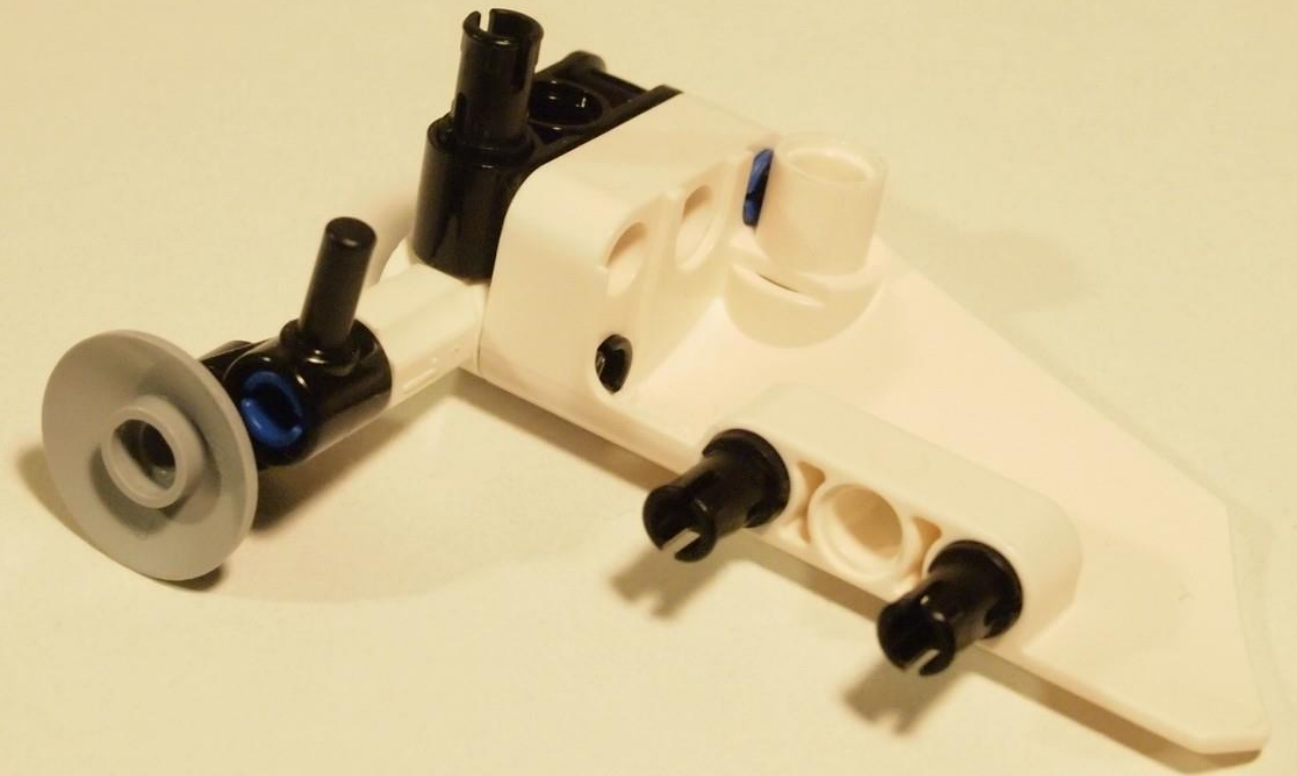



6x



1x



1x



1x



Use this for the **right** side!

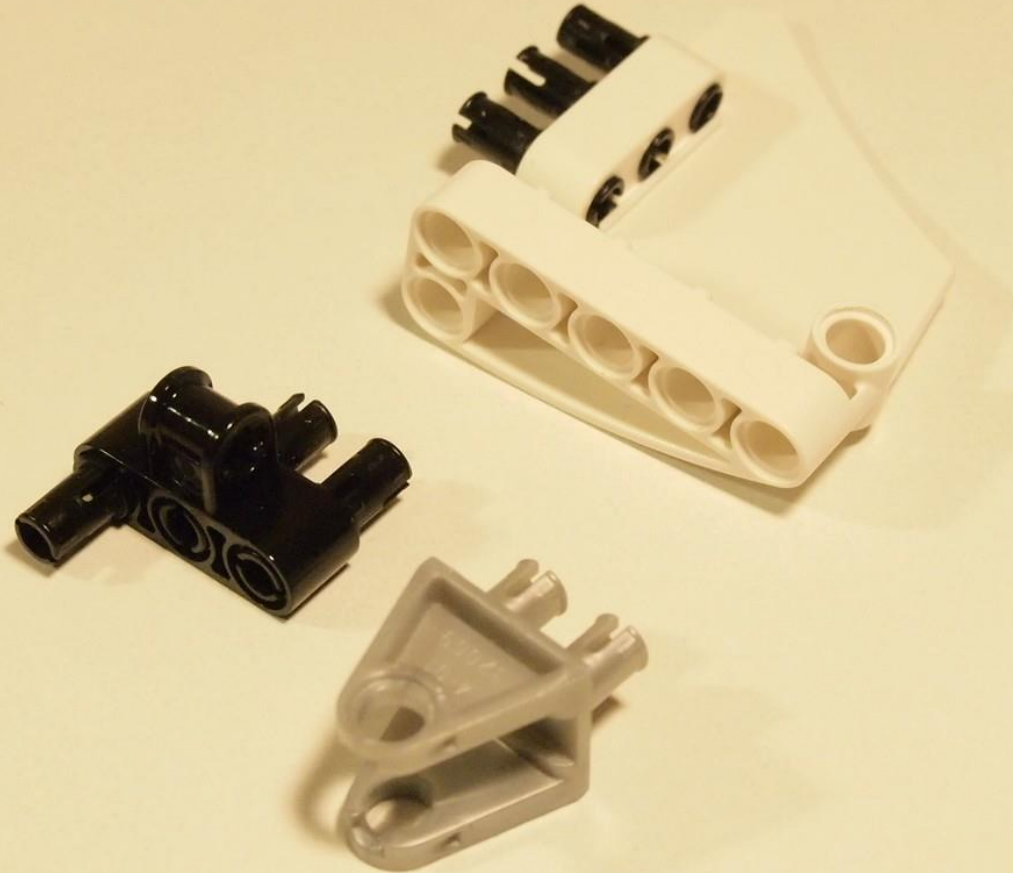





2x



1x



1x



Use this for the **right** side!

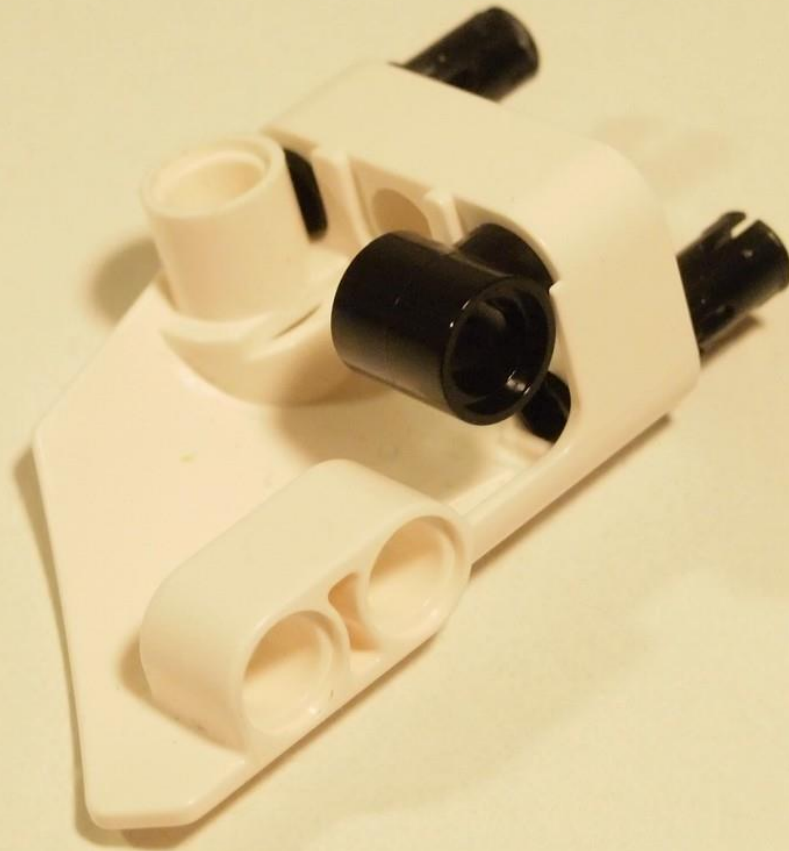



1x



Use this for the **right** side!

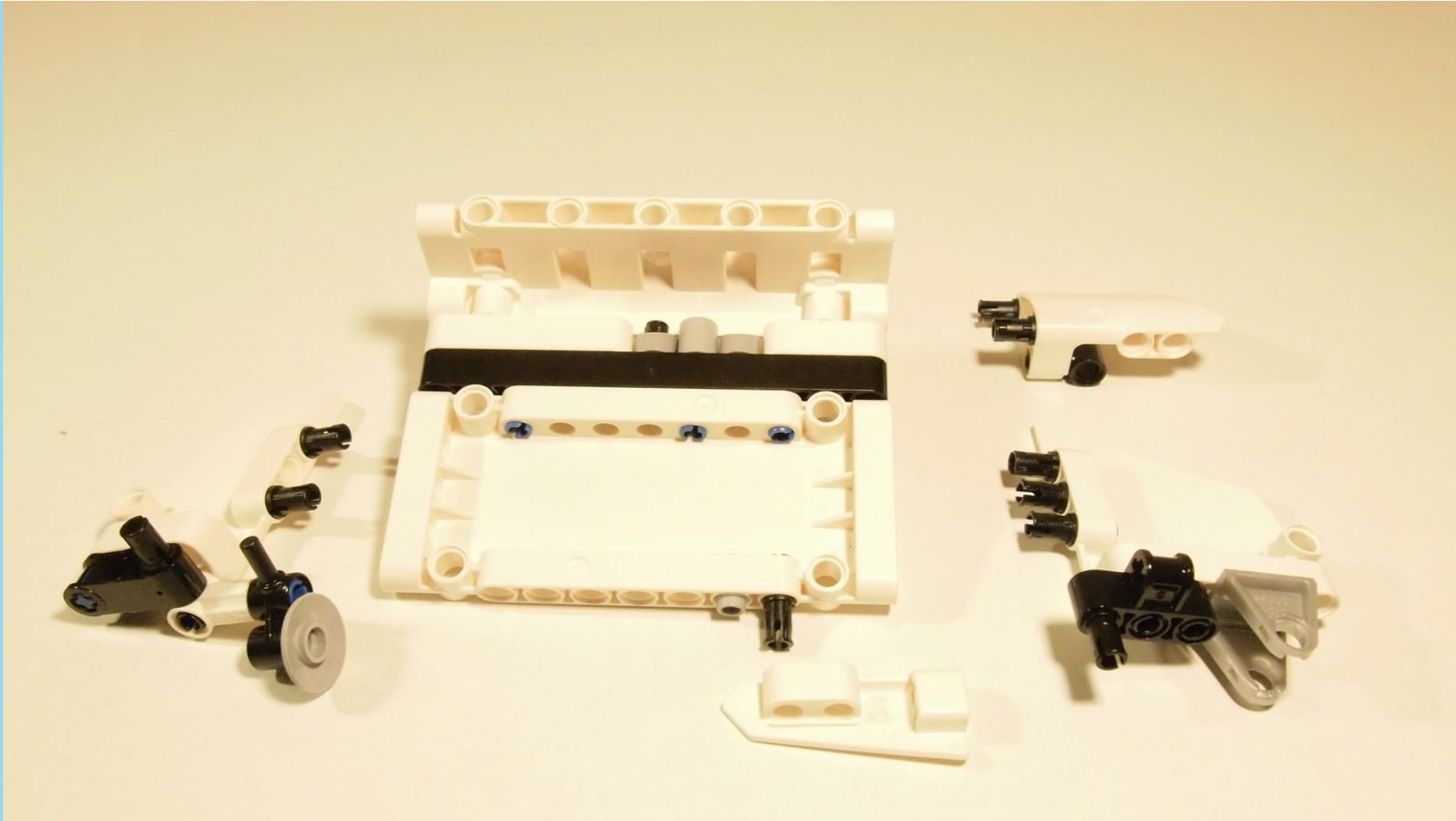

11

7



1x

1x

4x

1x

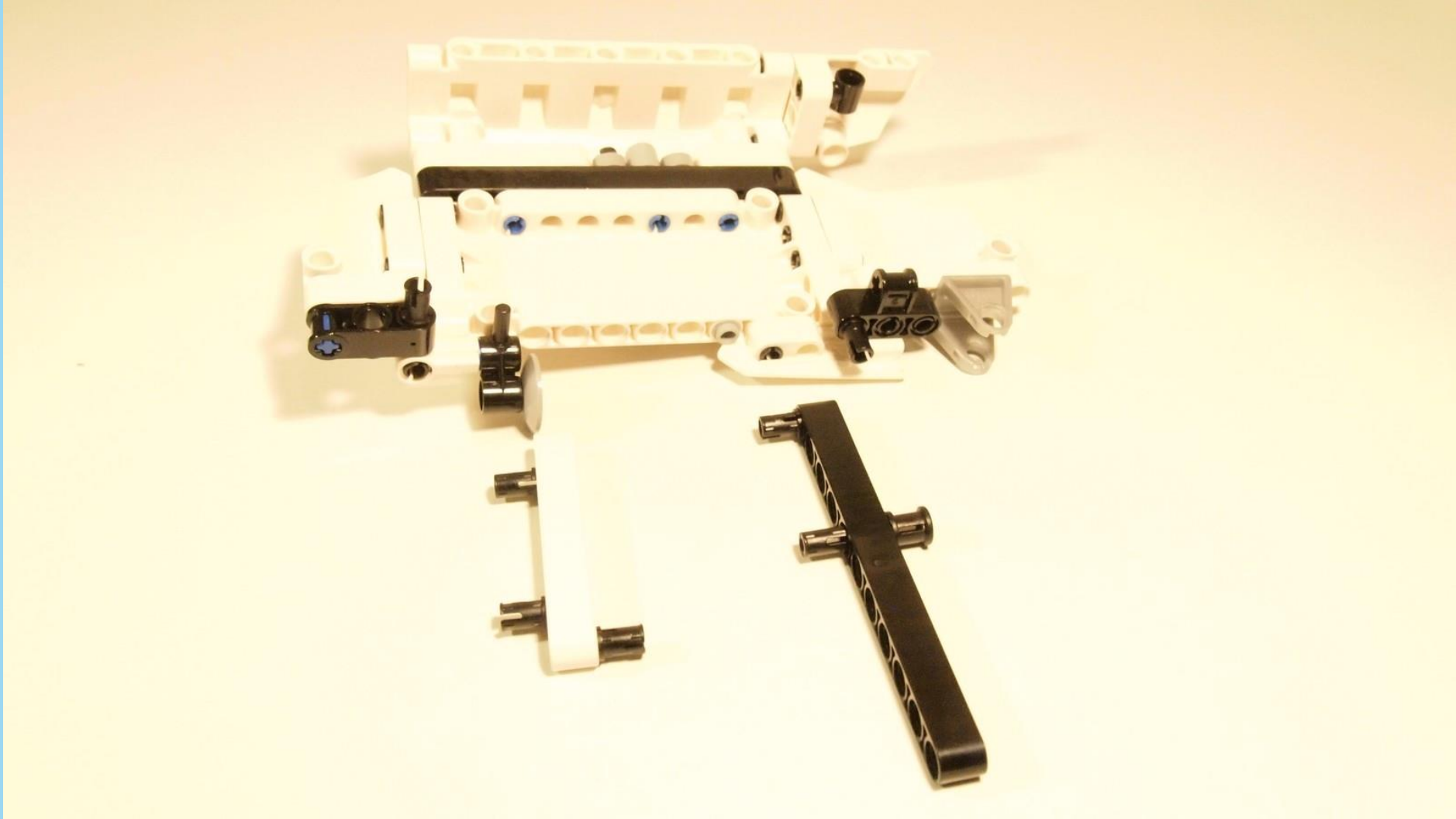



1x



1x



1x



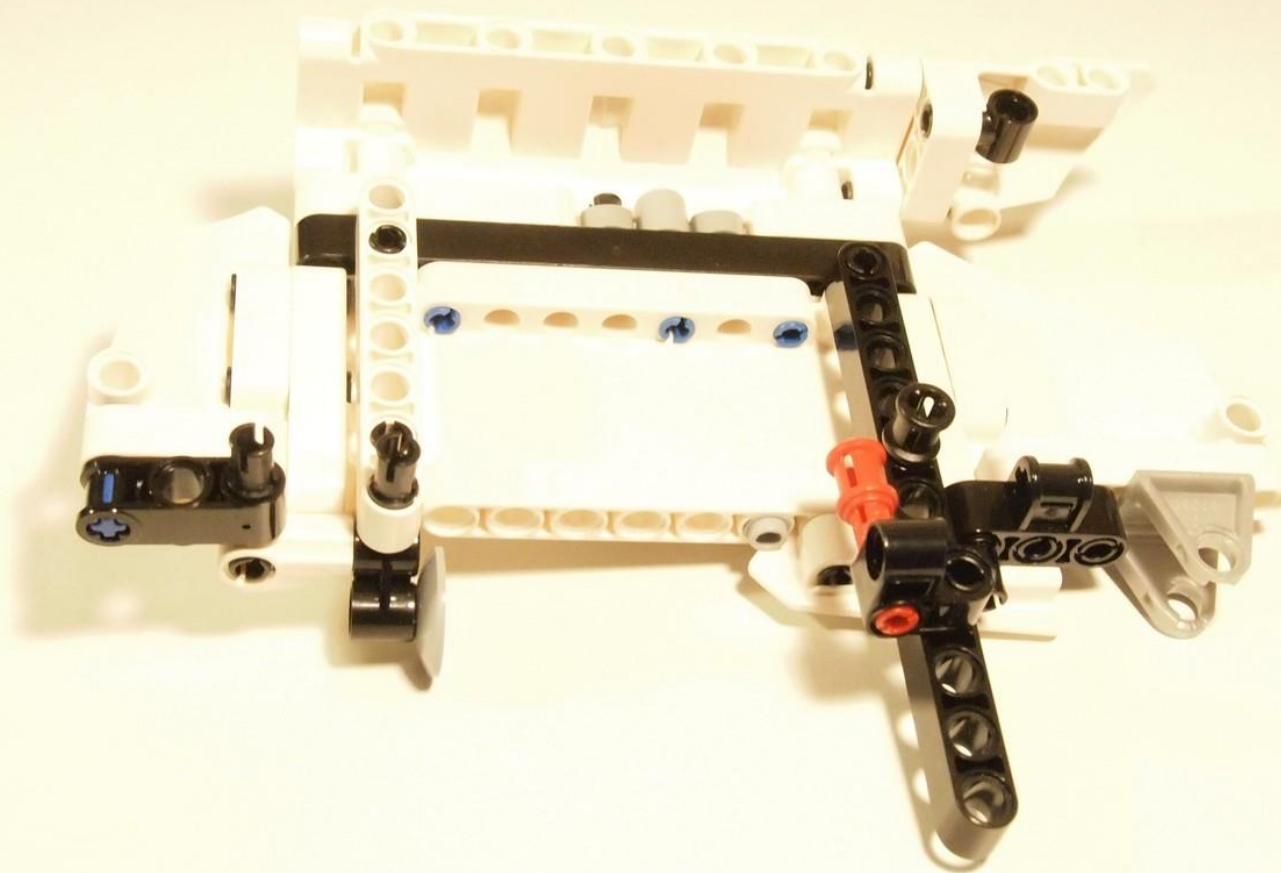

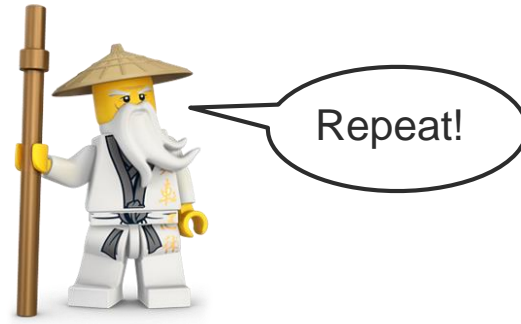

15



1x



4x



3x



2x

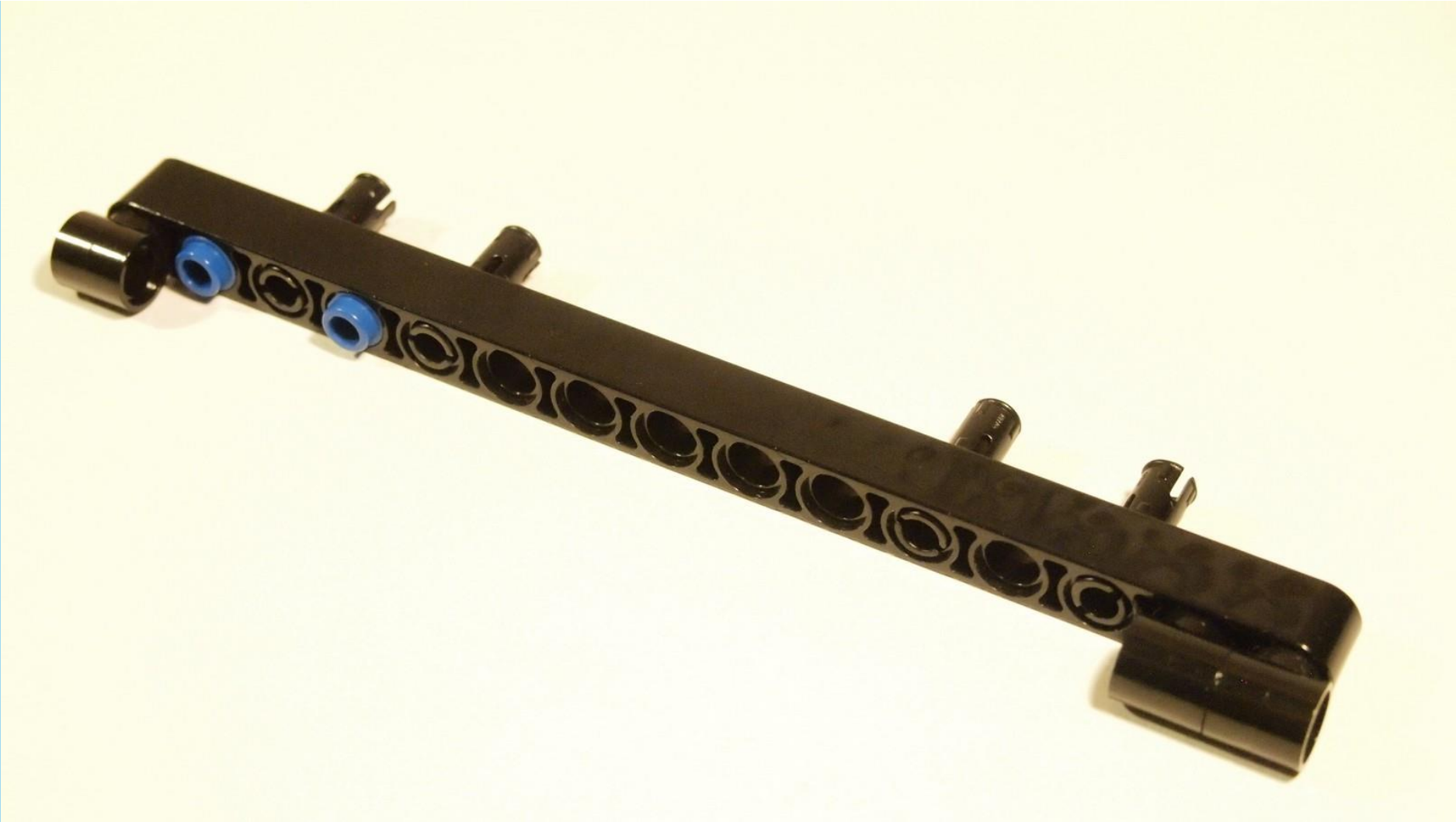



1x



2x



1x



1x



2x





1x



1x



1x



1x

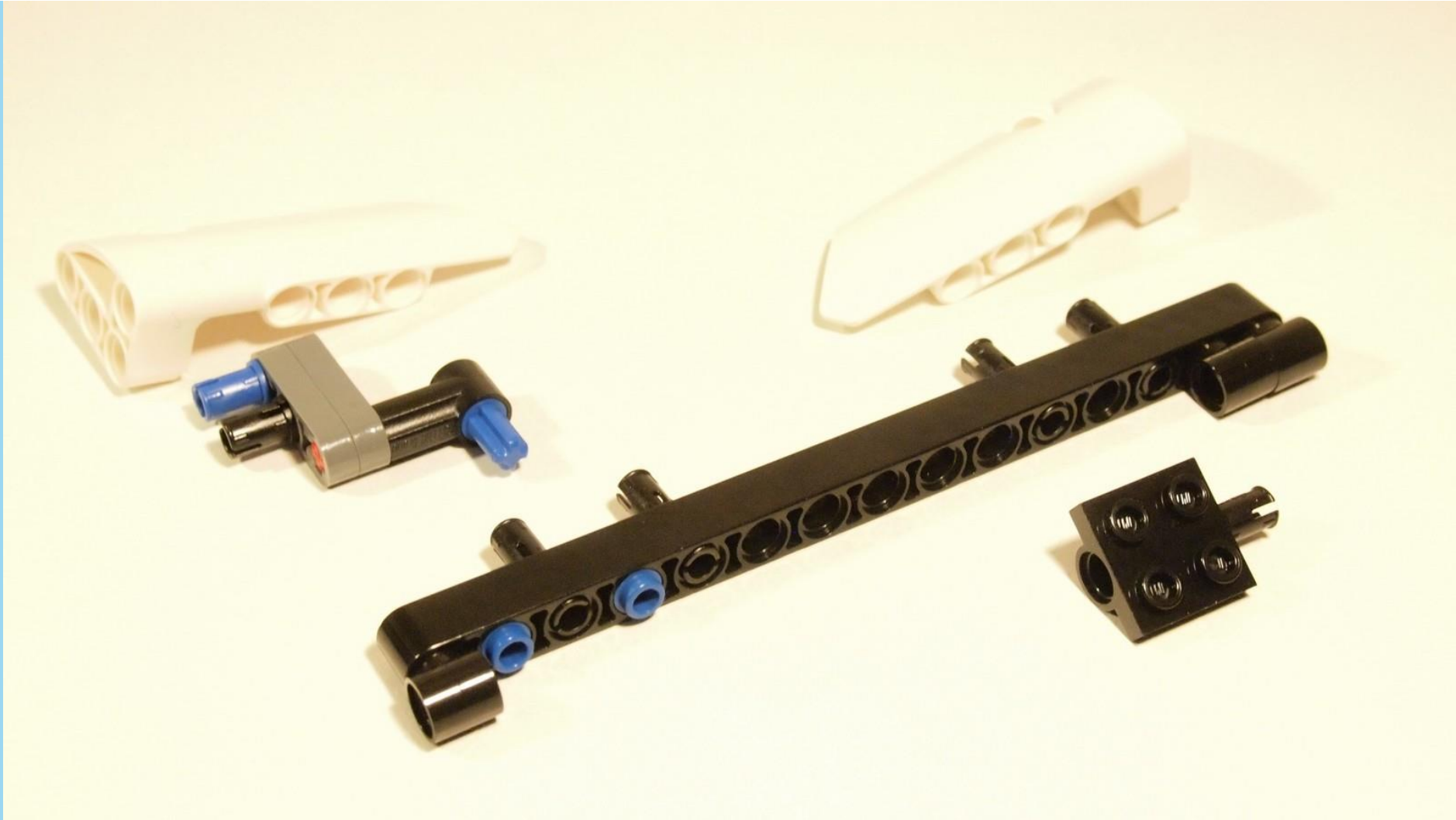

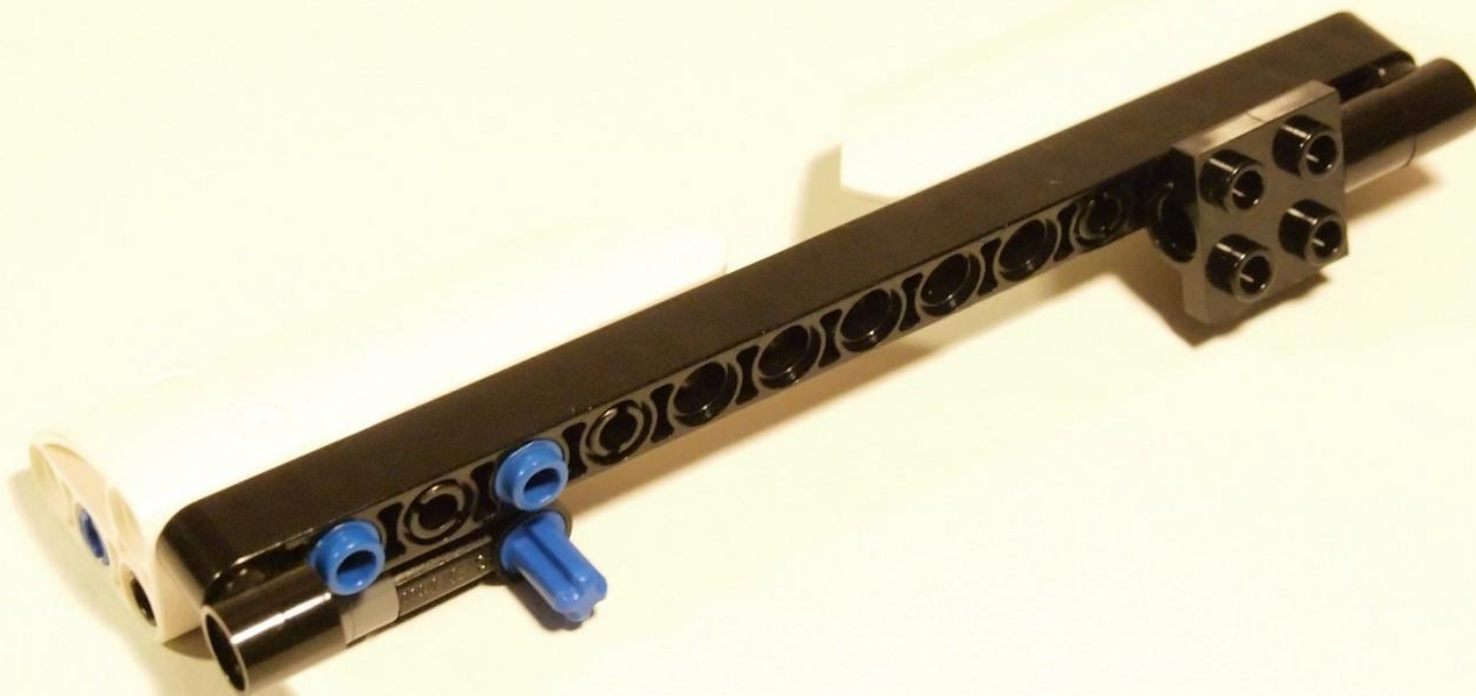



1x



1x



1x

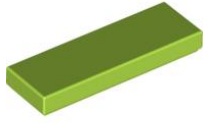

2x

3



1x

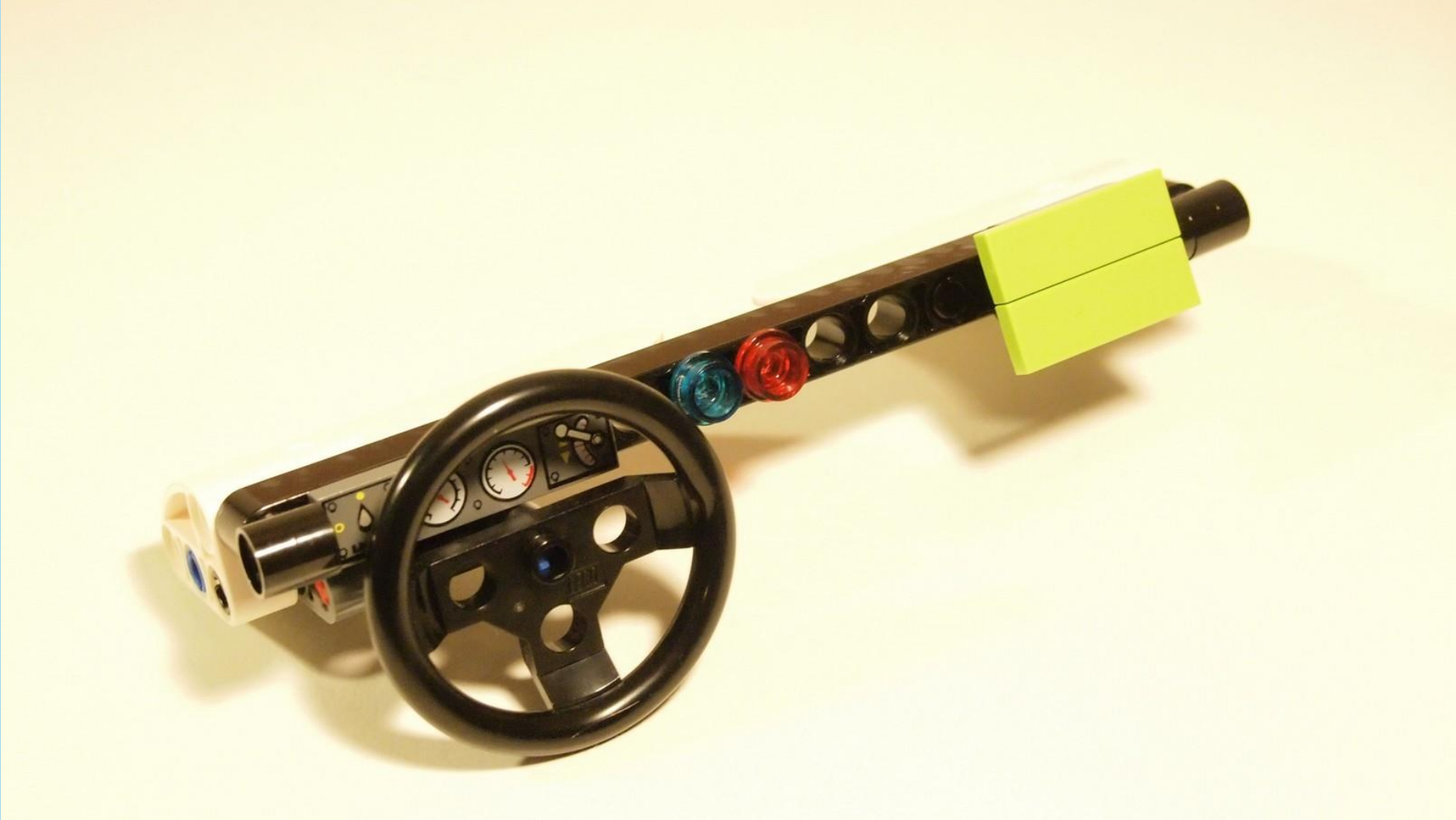

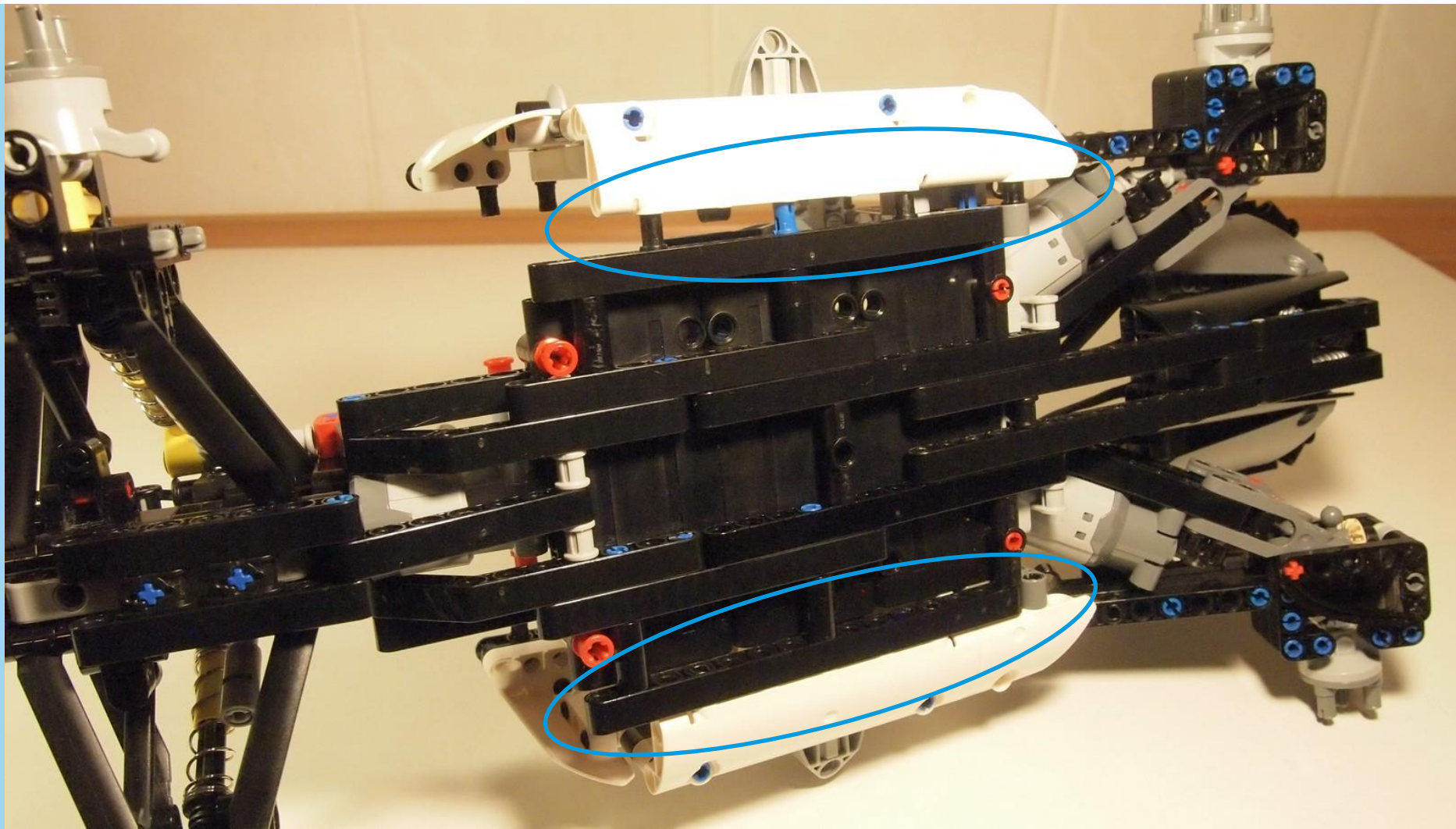

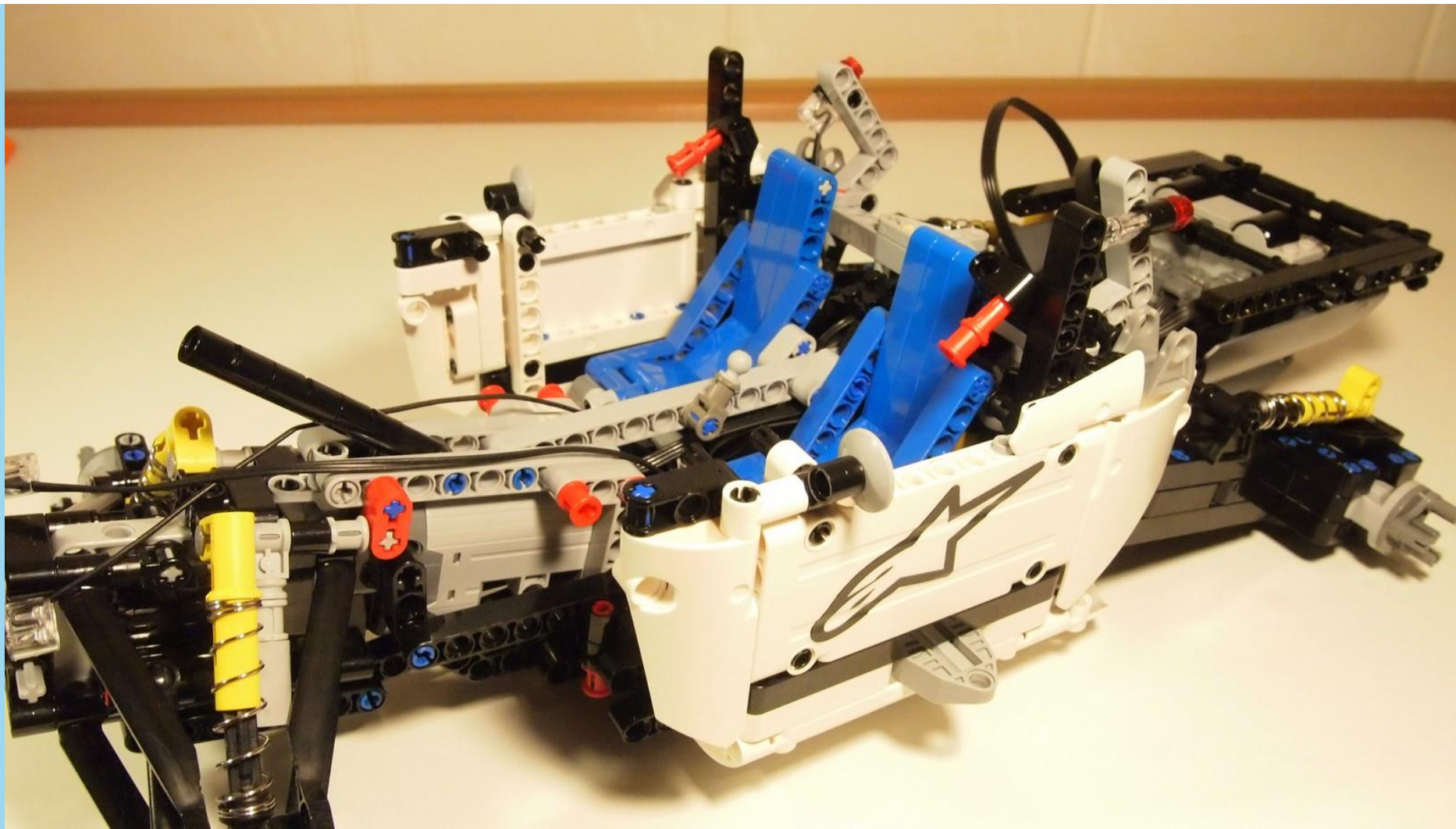



There is some stretch on both sides, illegal, but **needed** here.

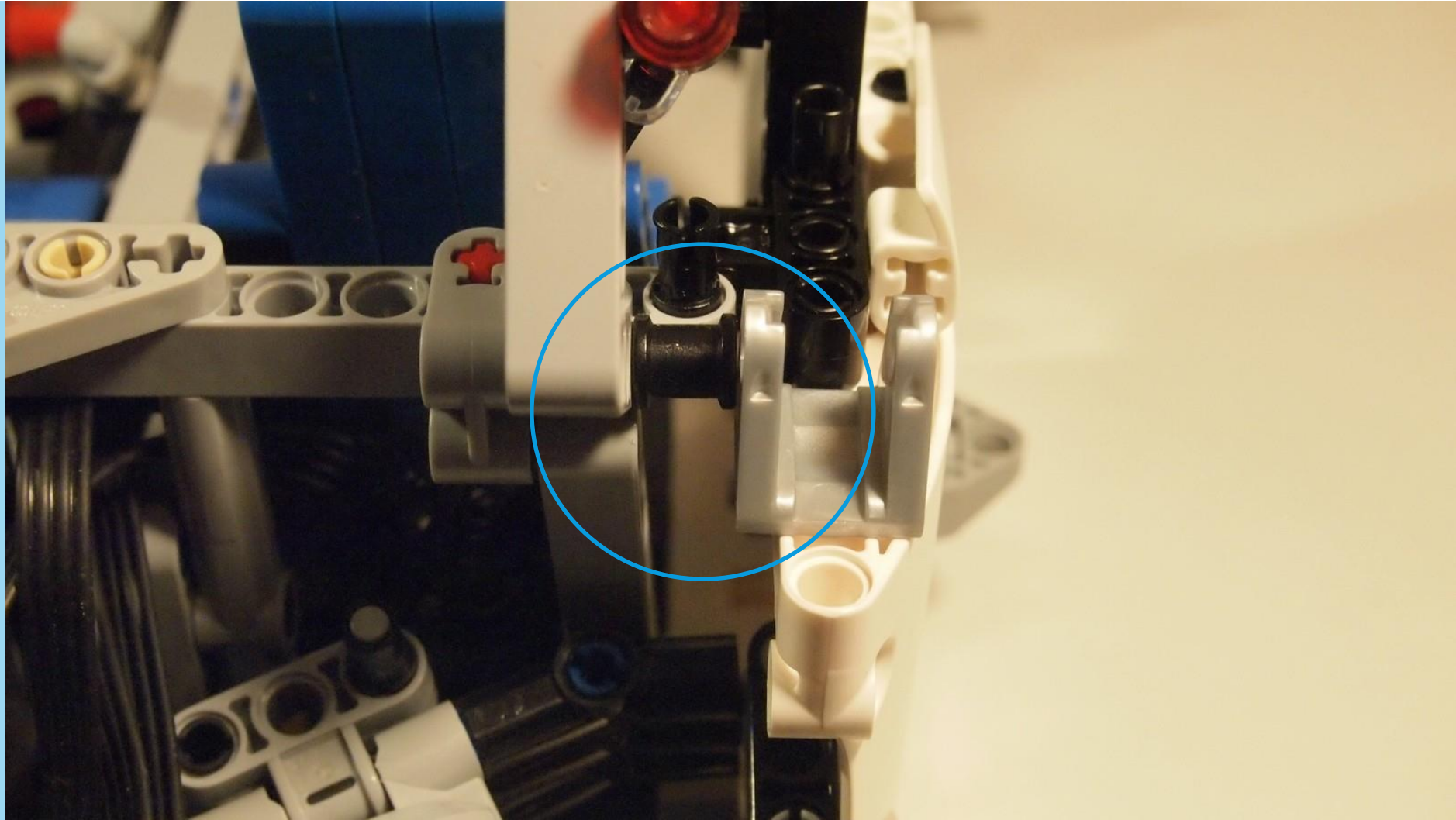

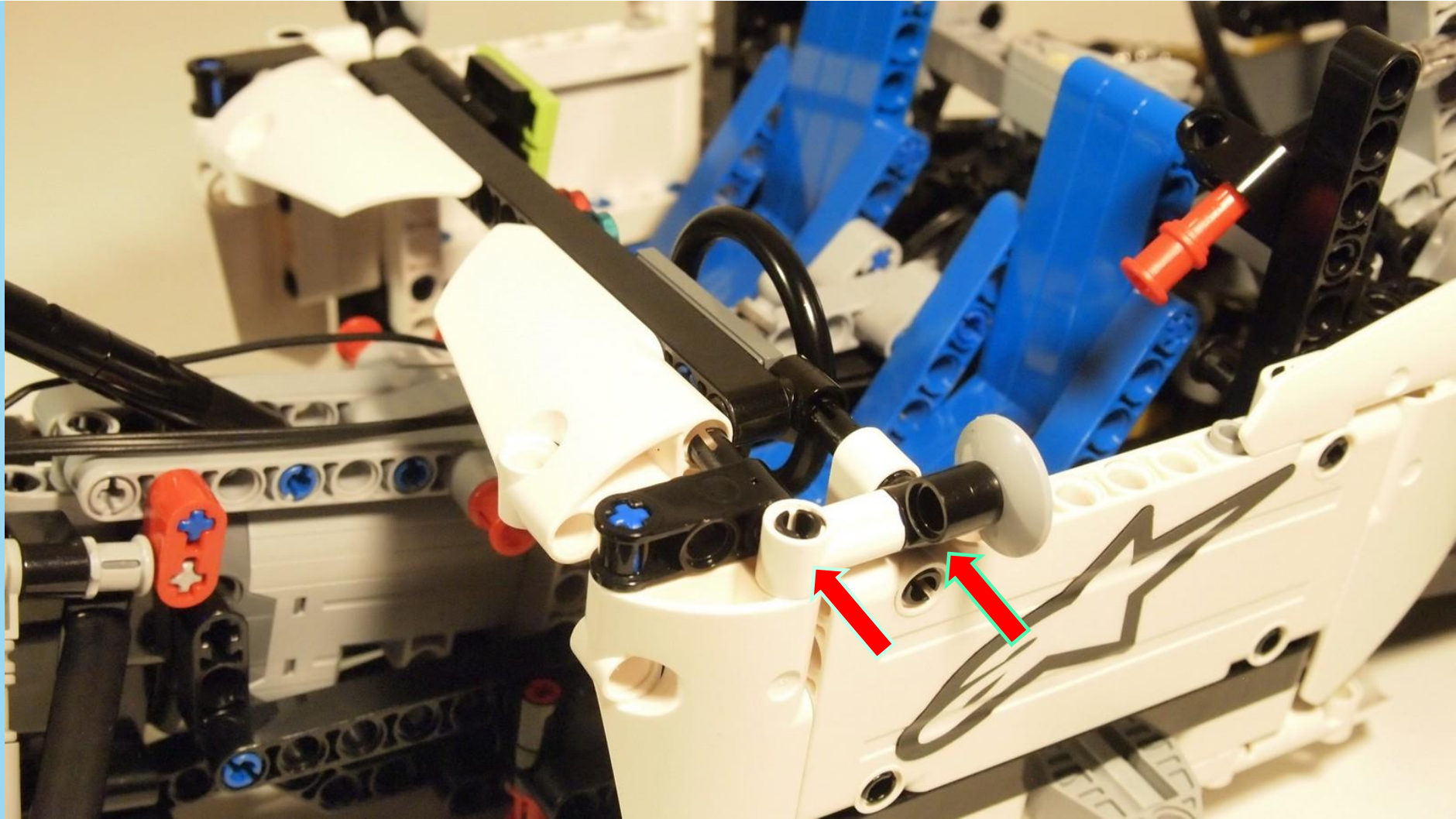

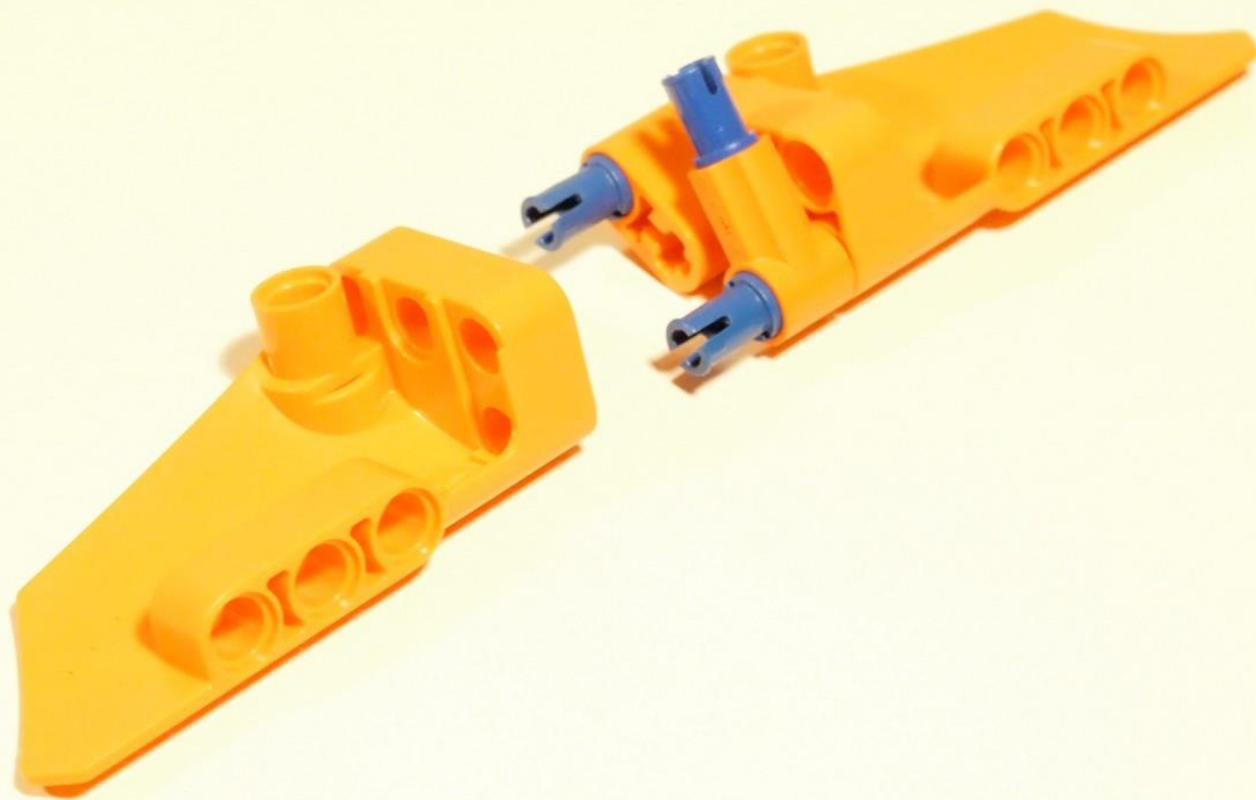
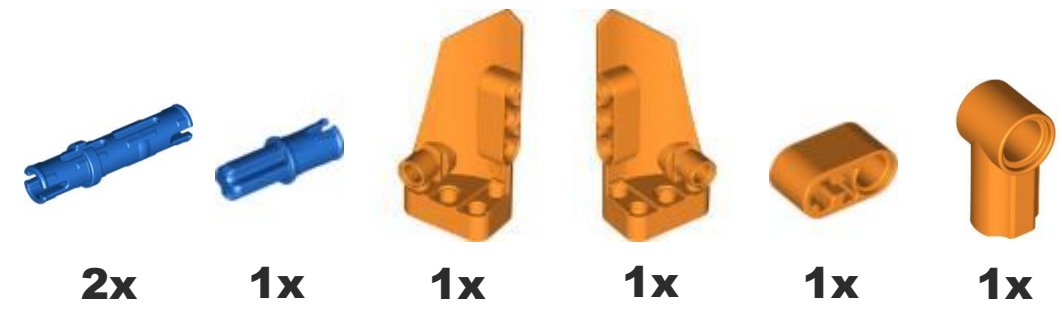

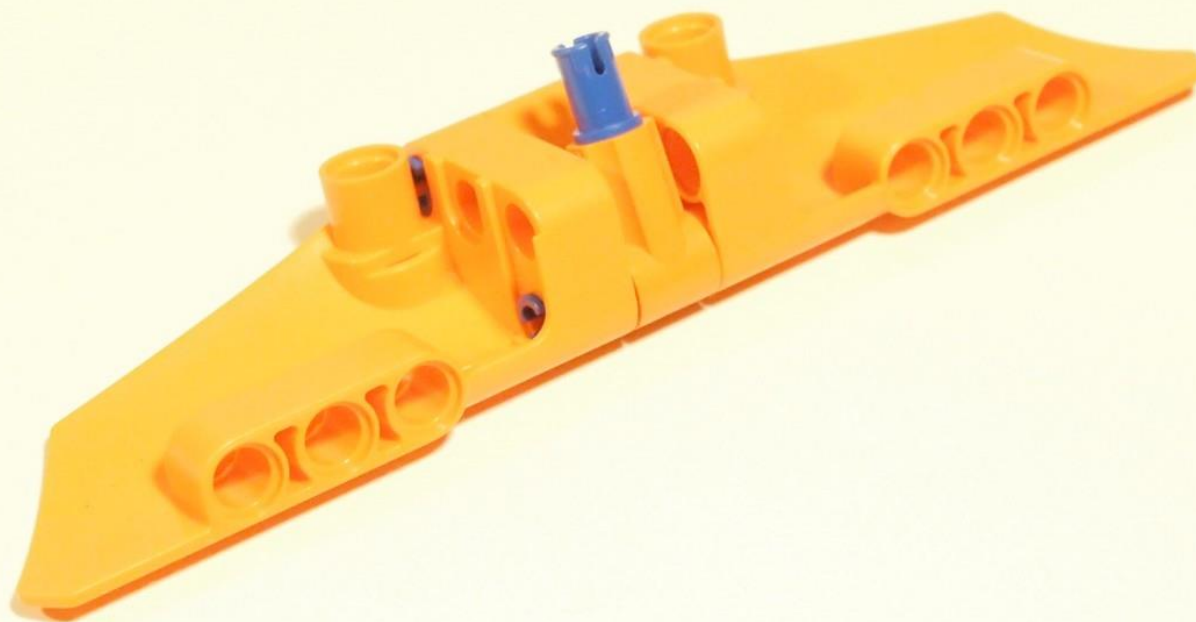



8x



3x

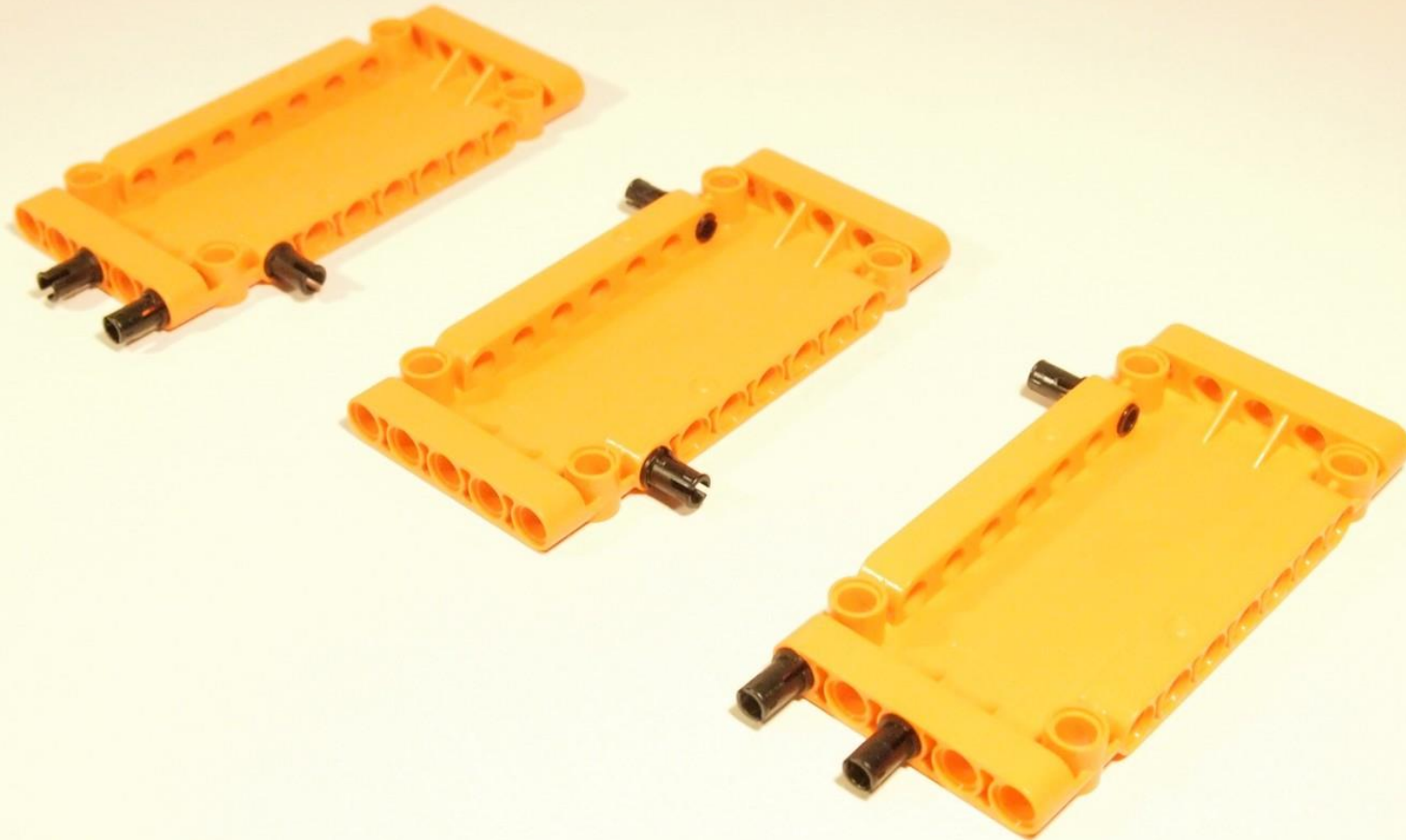

15



1x



2x



4x

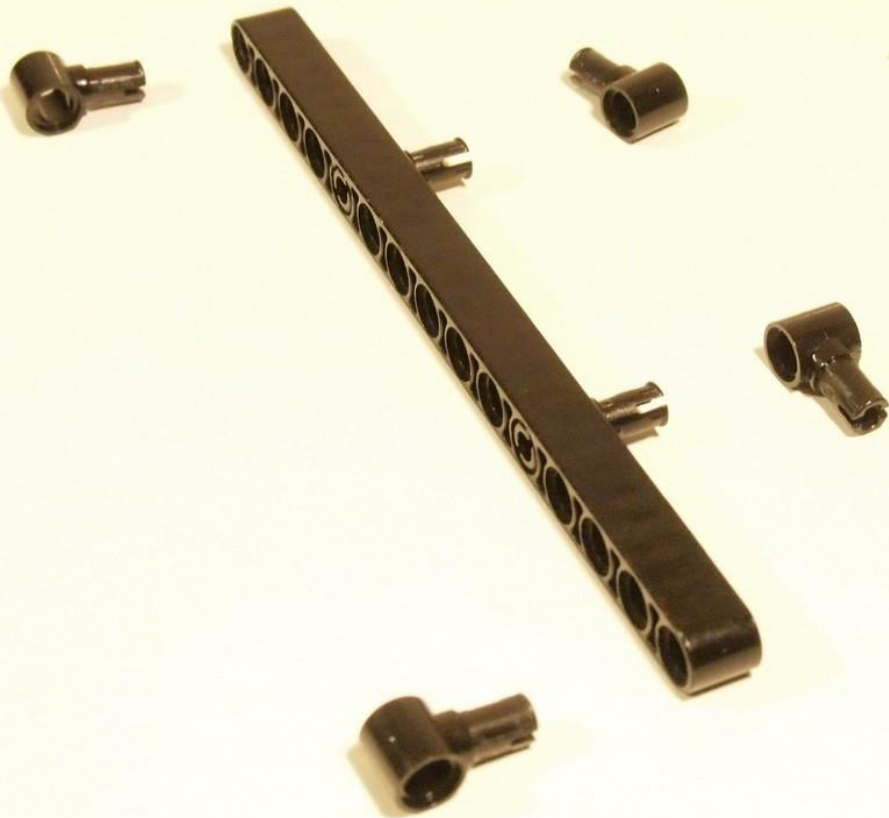

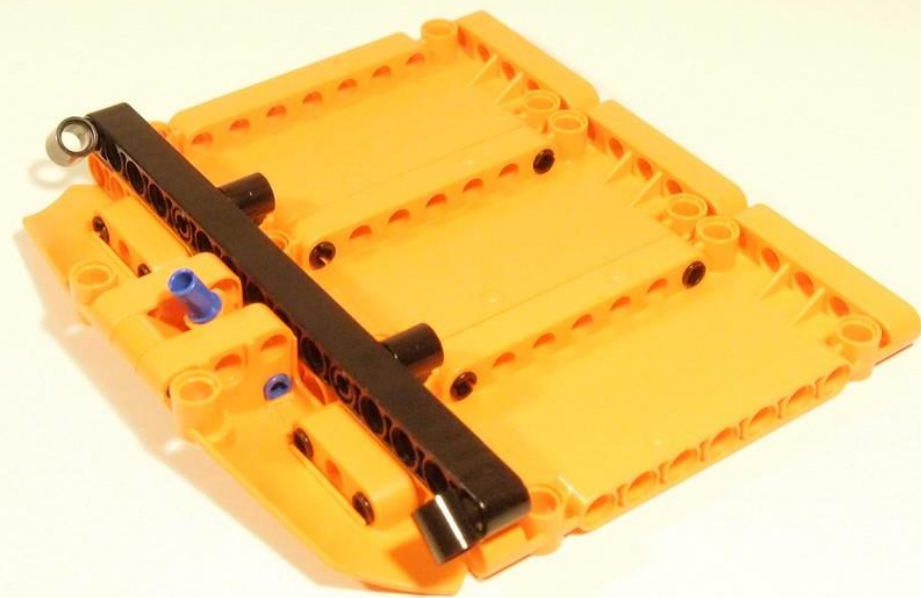



7x



8x

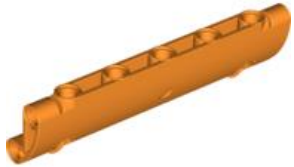

1x



2x

8

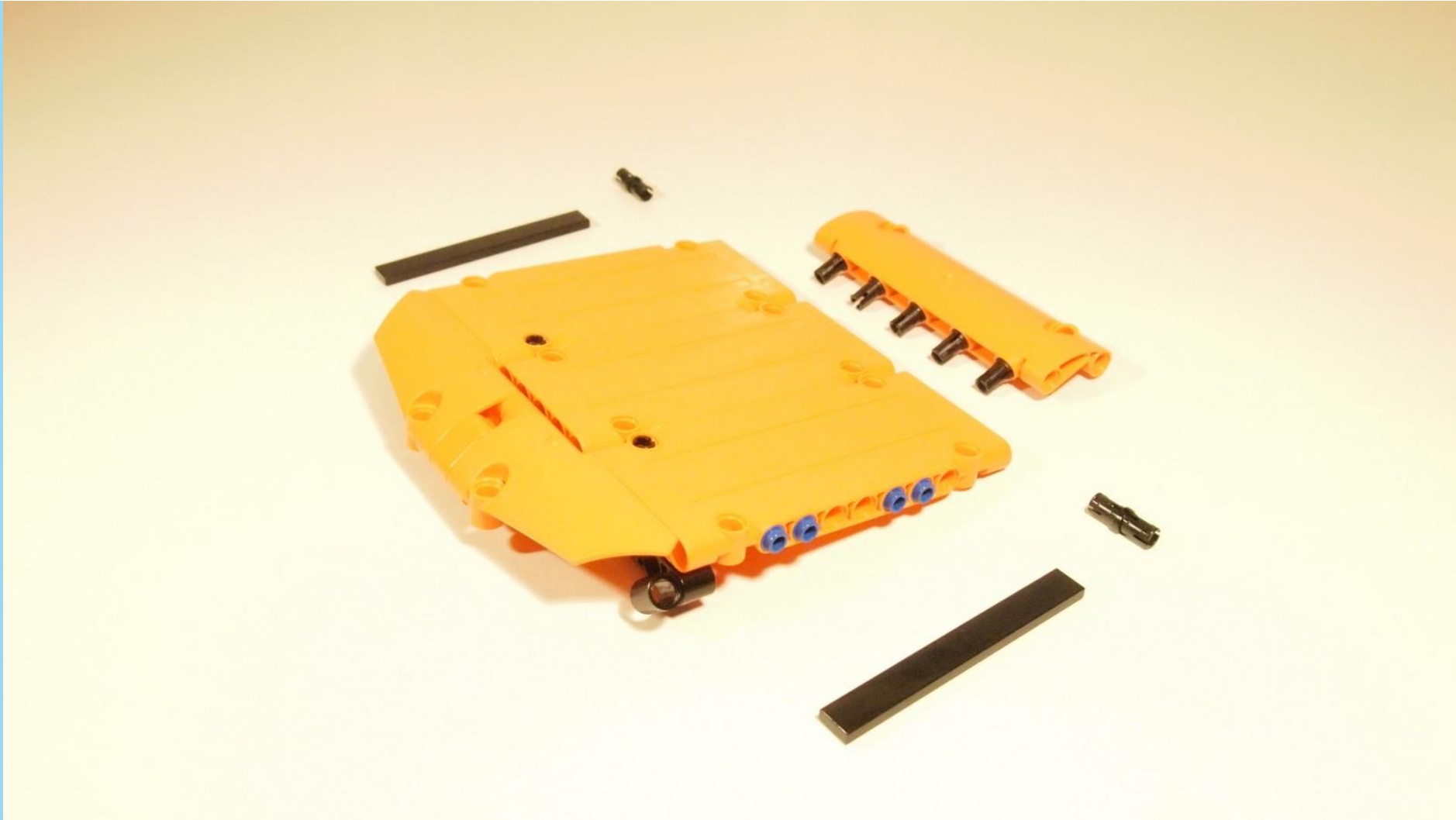

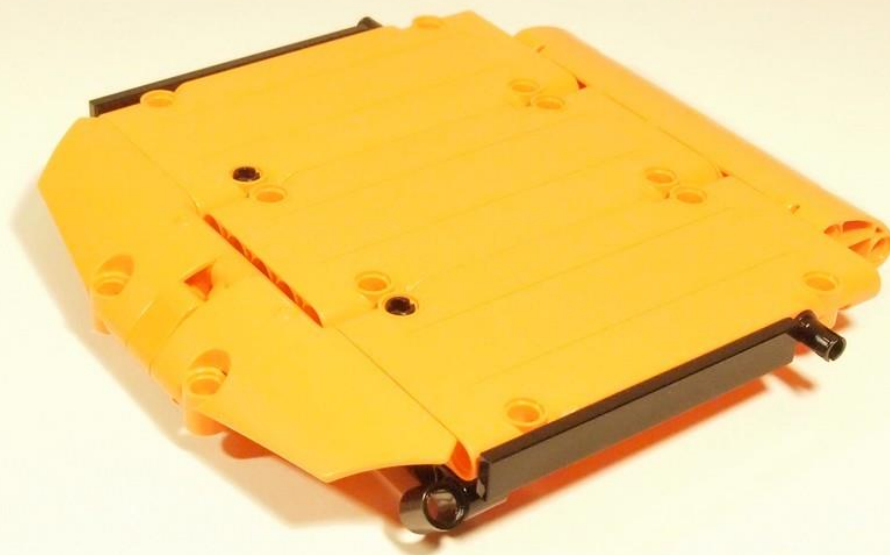

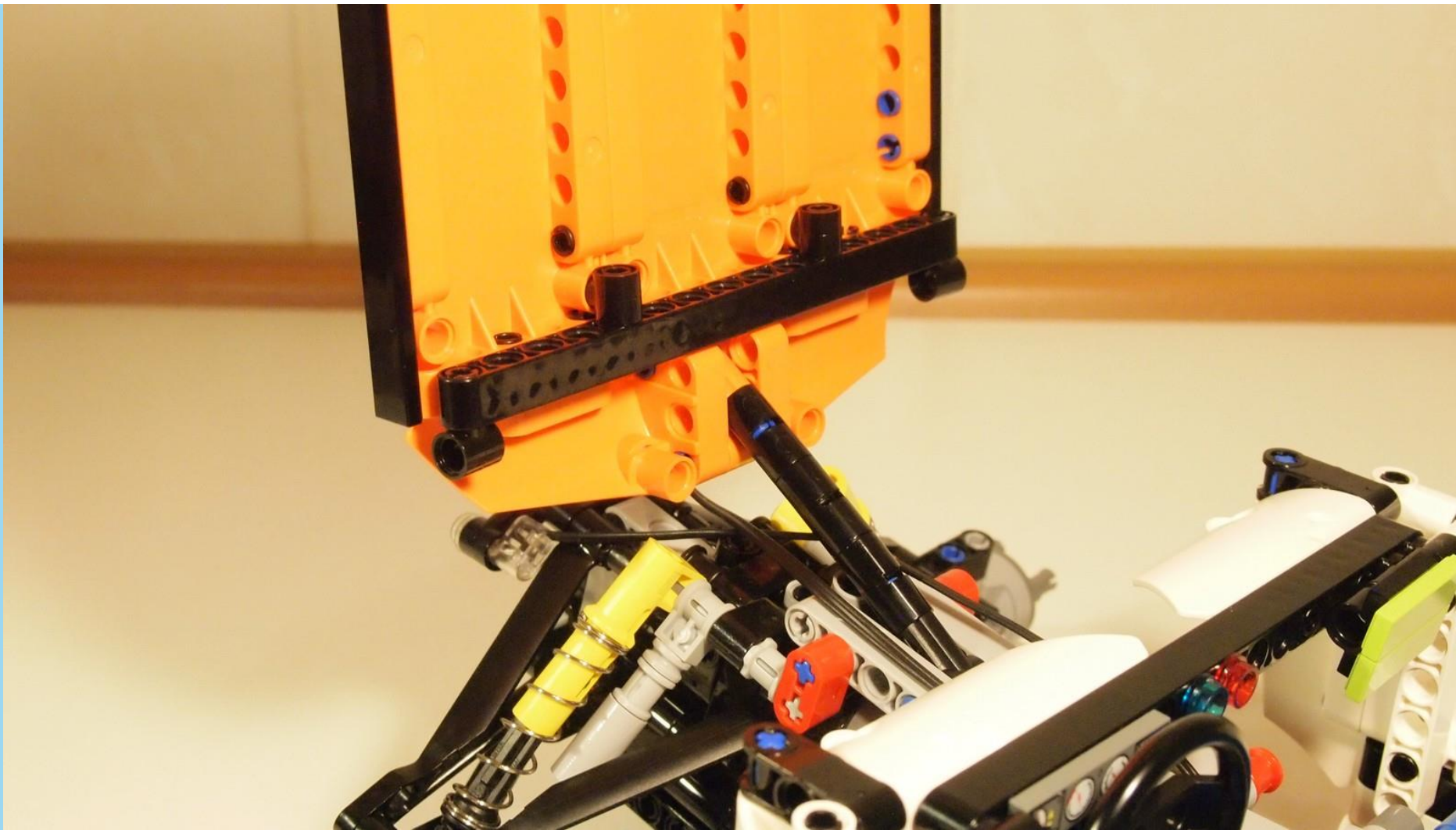

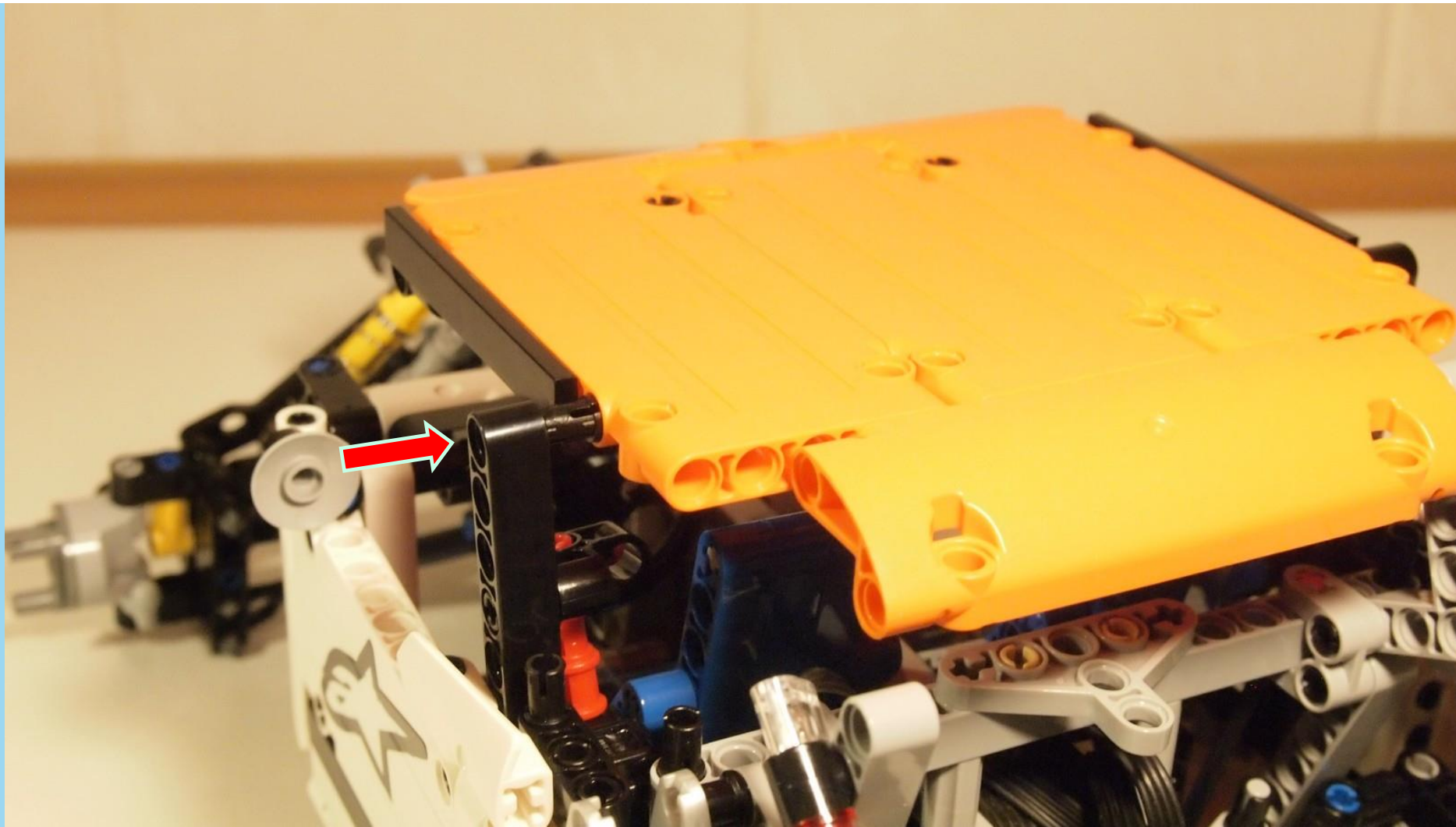



2x

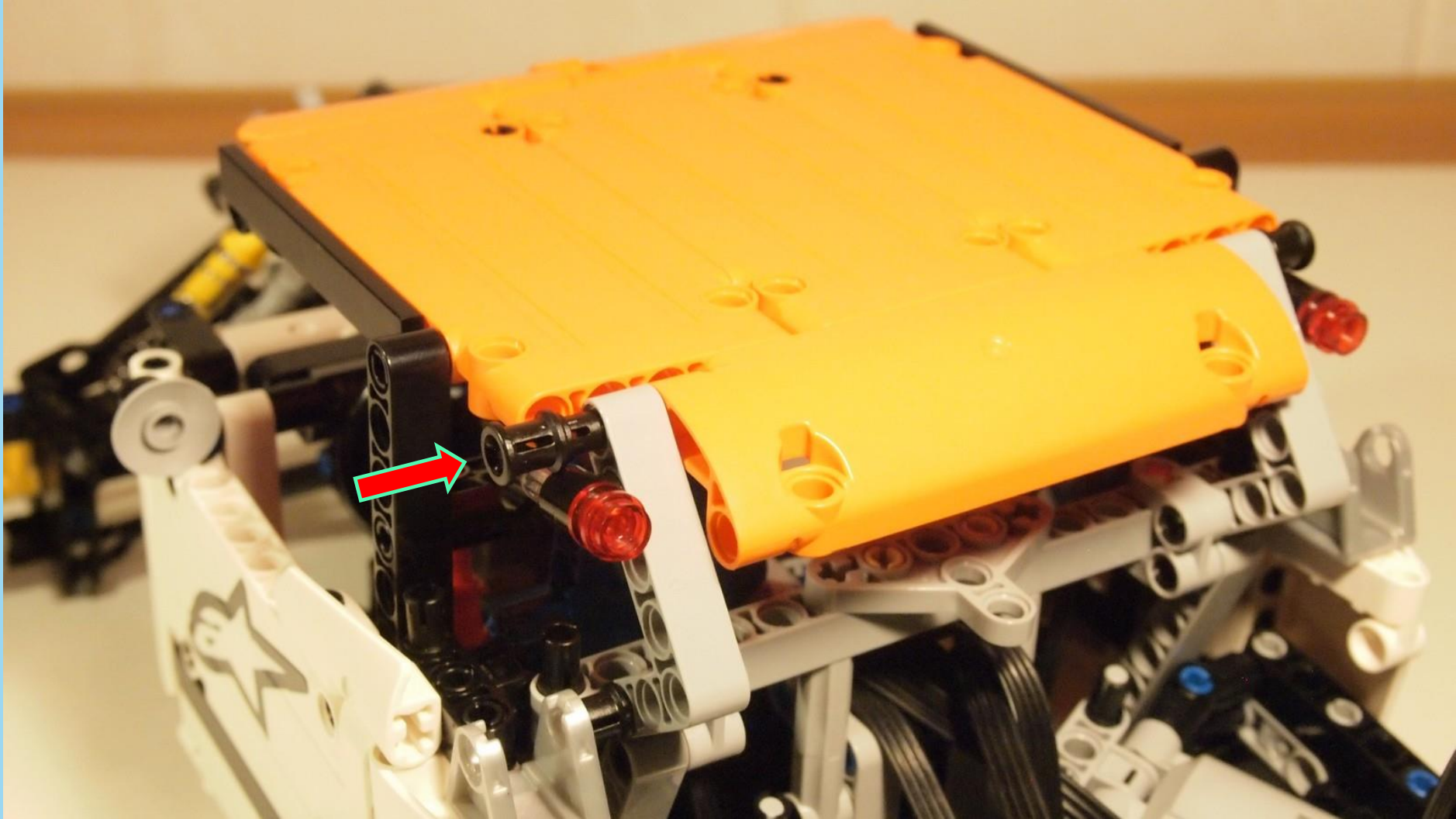

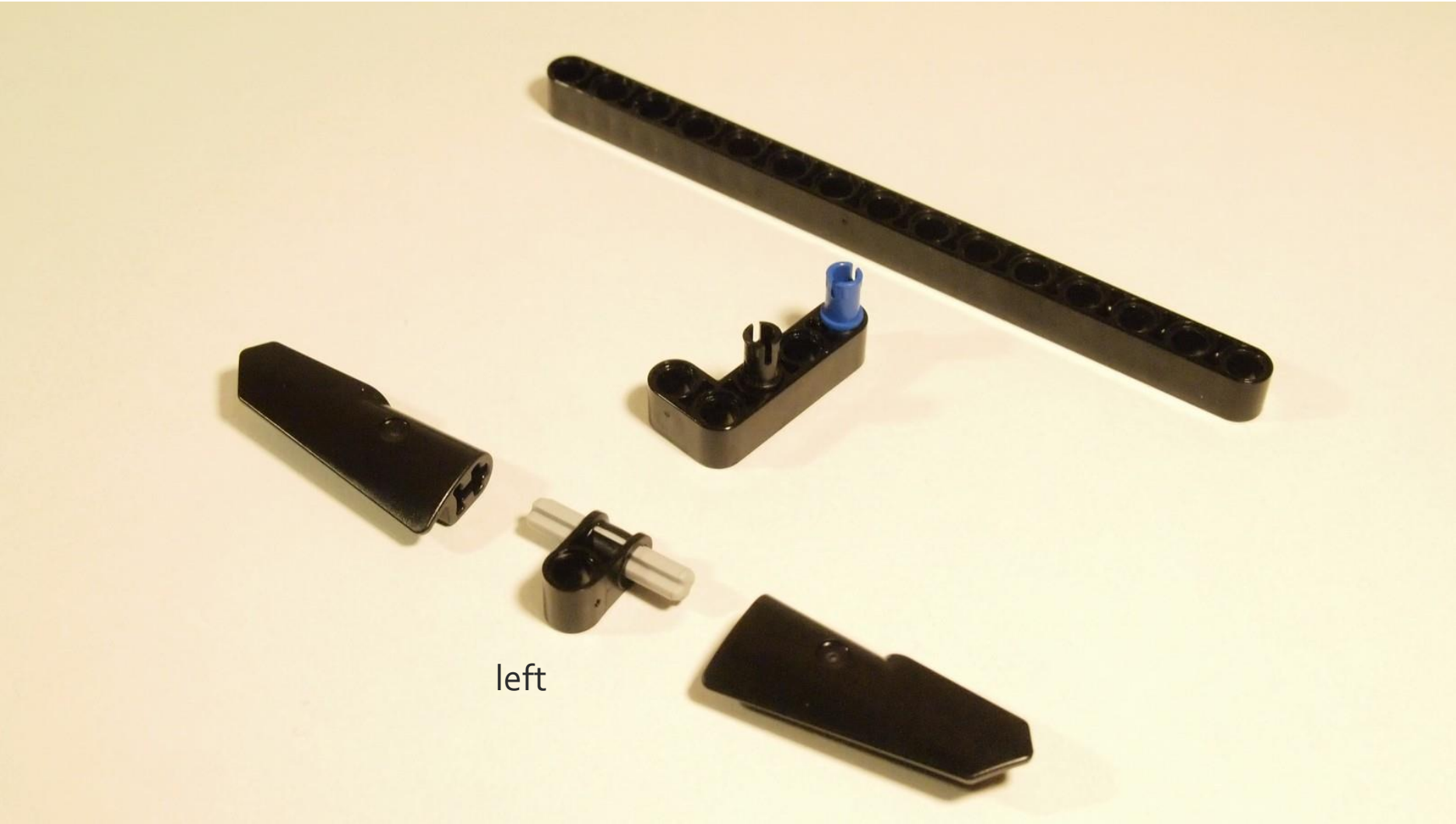
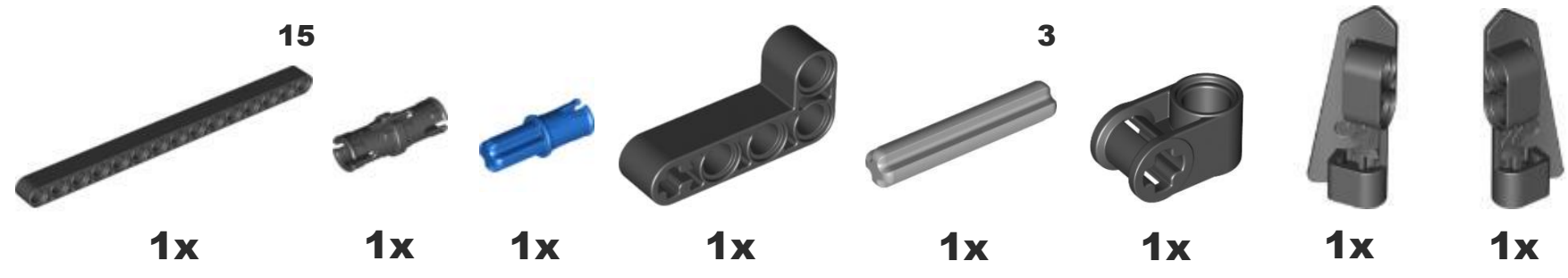

x2

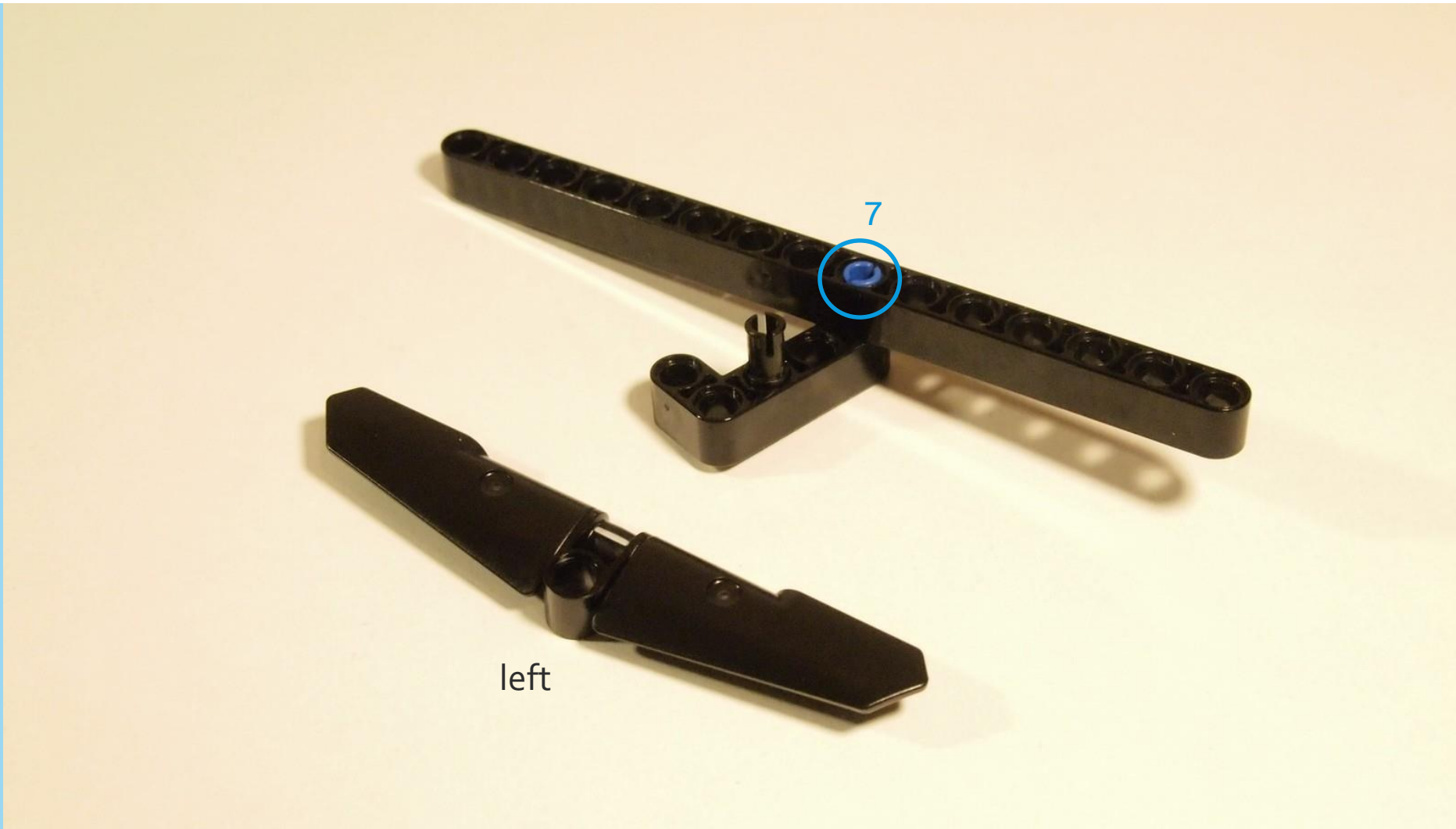

x2



2x



2x

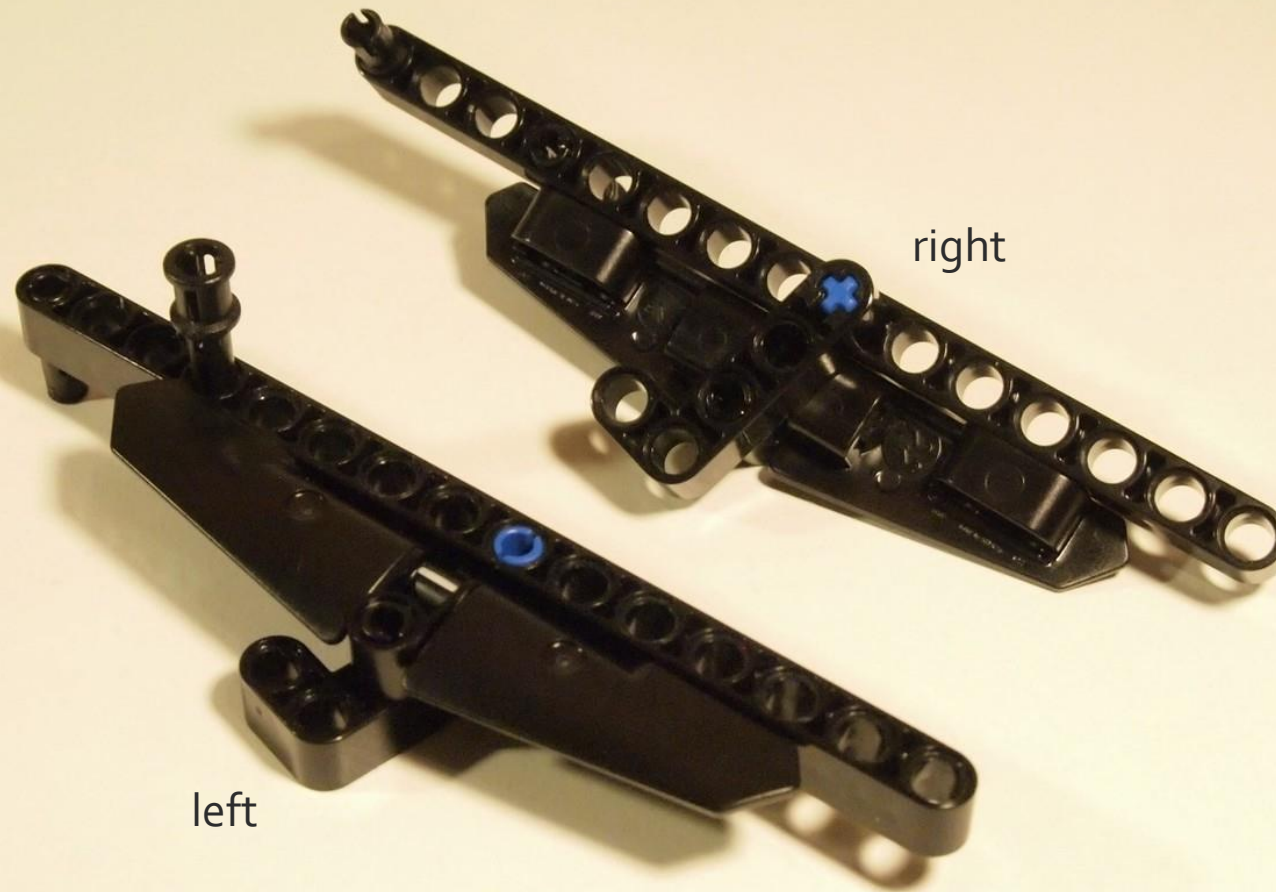

right

left

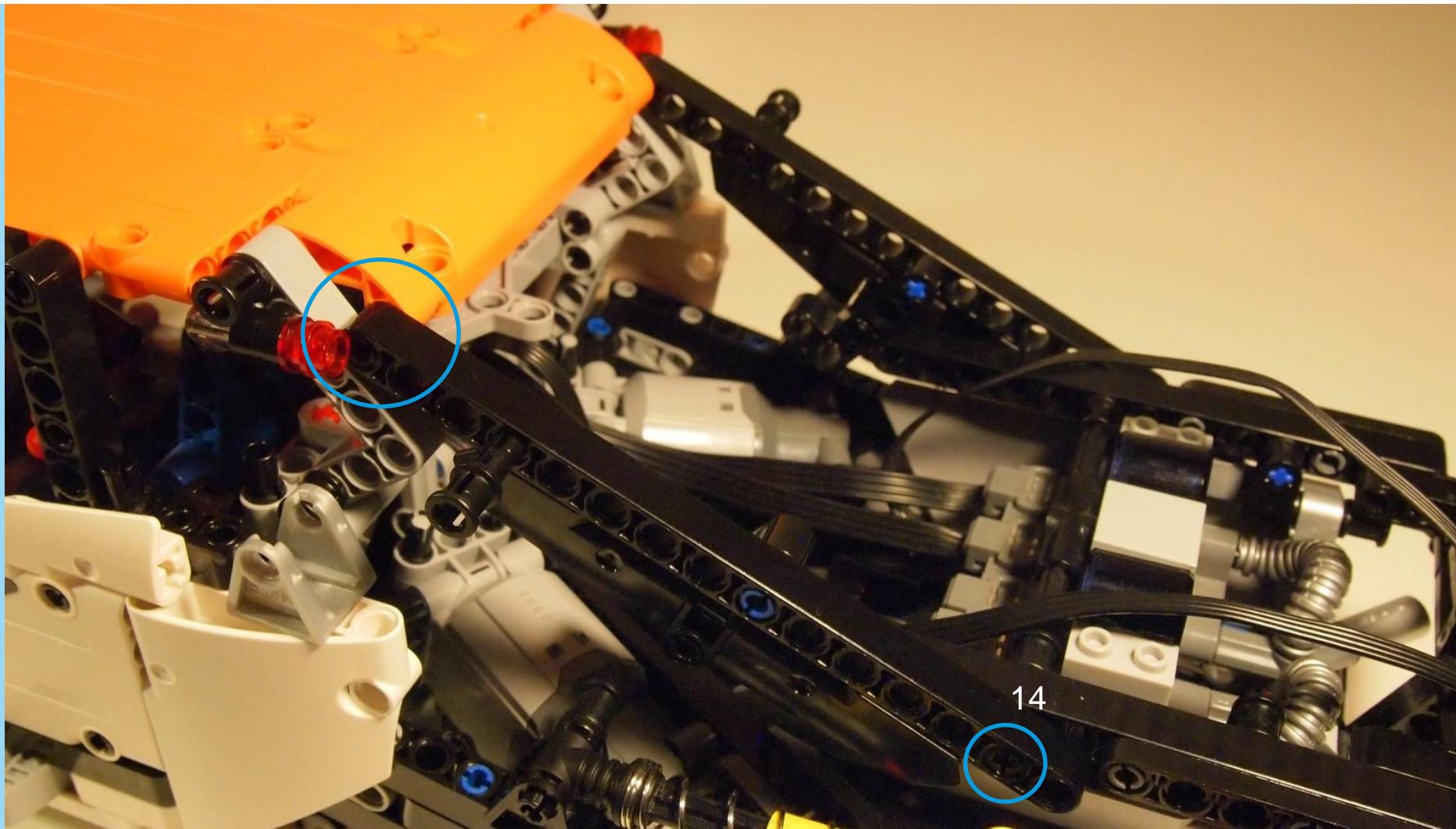

14

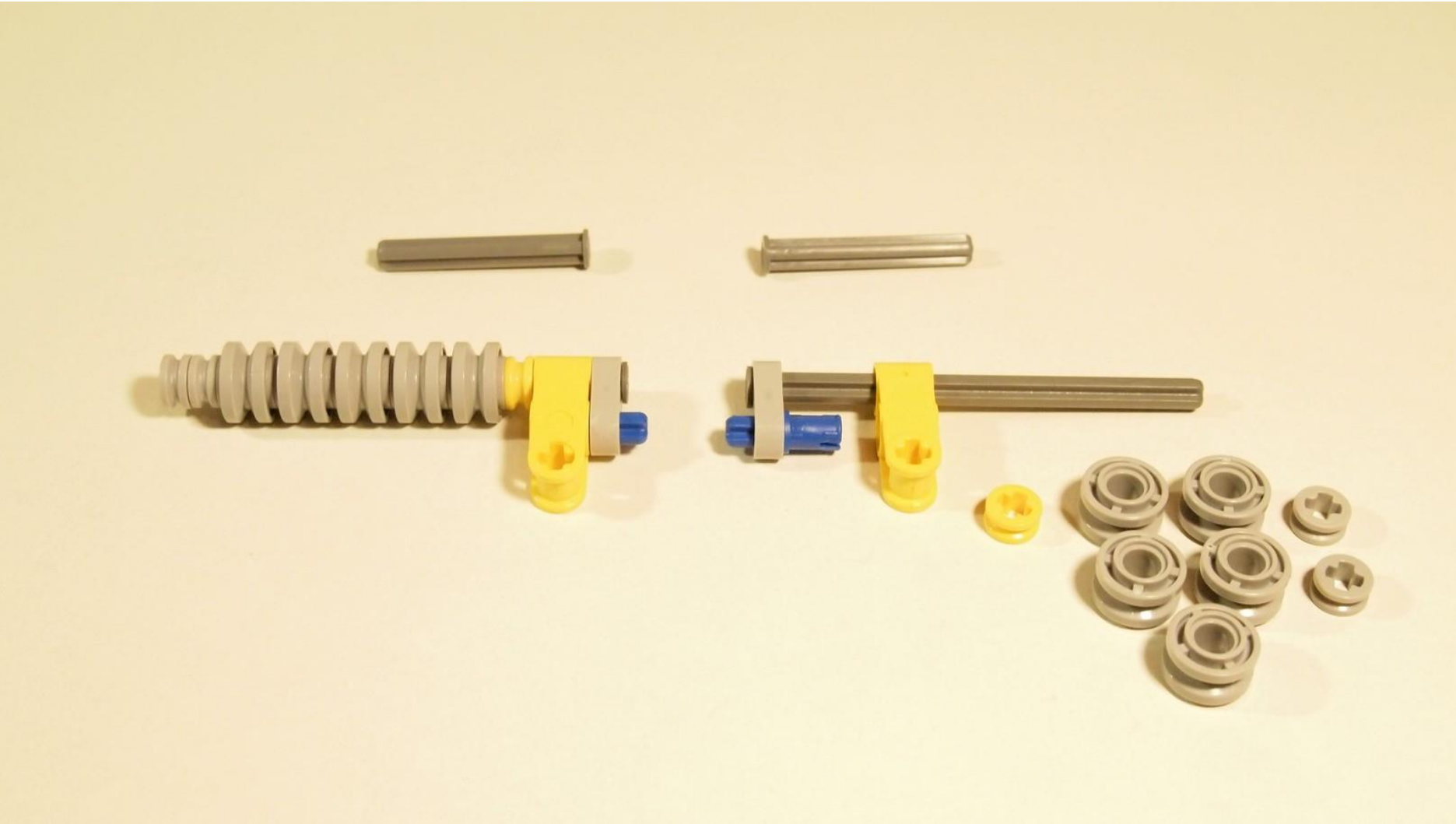
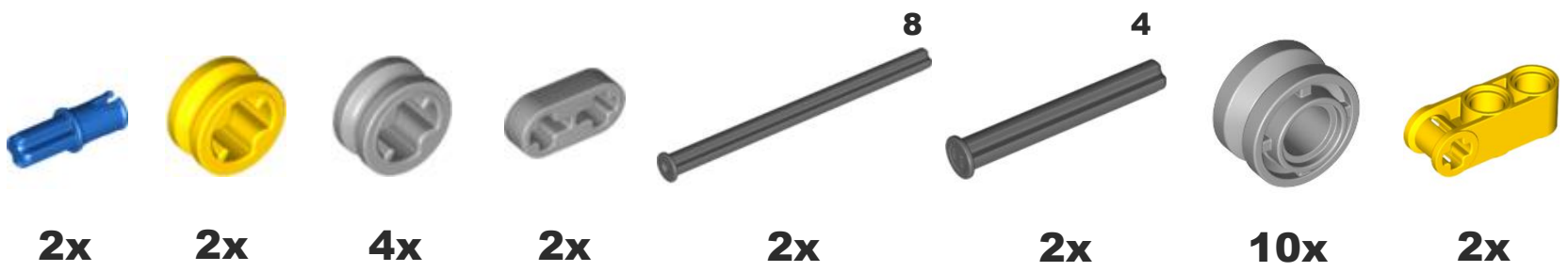

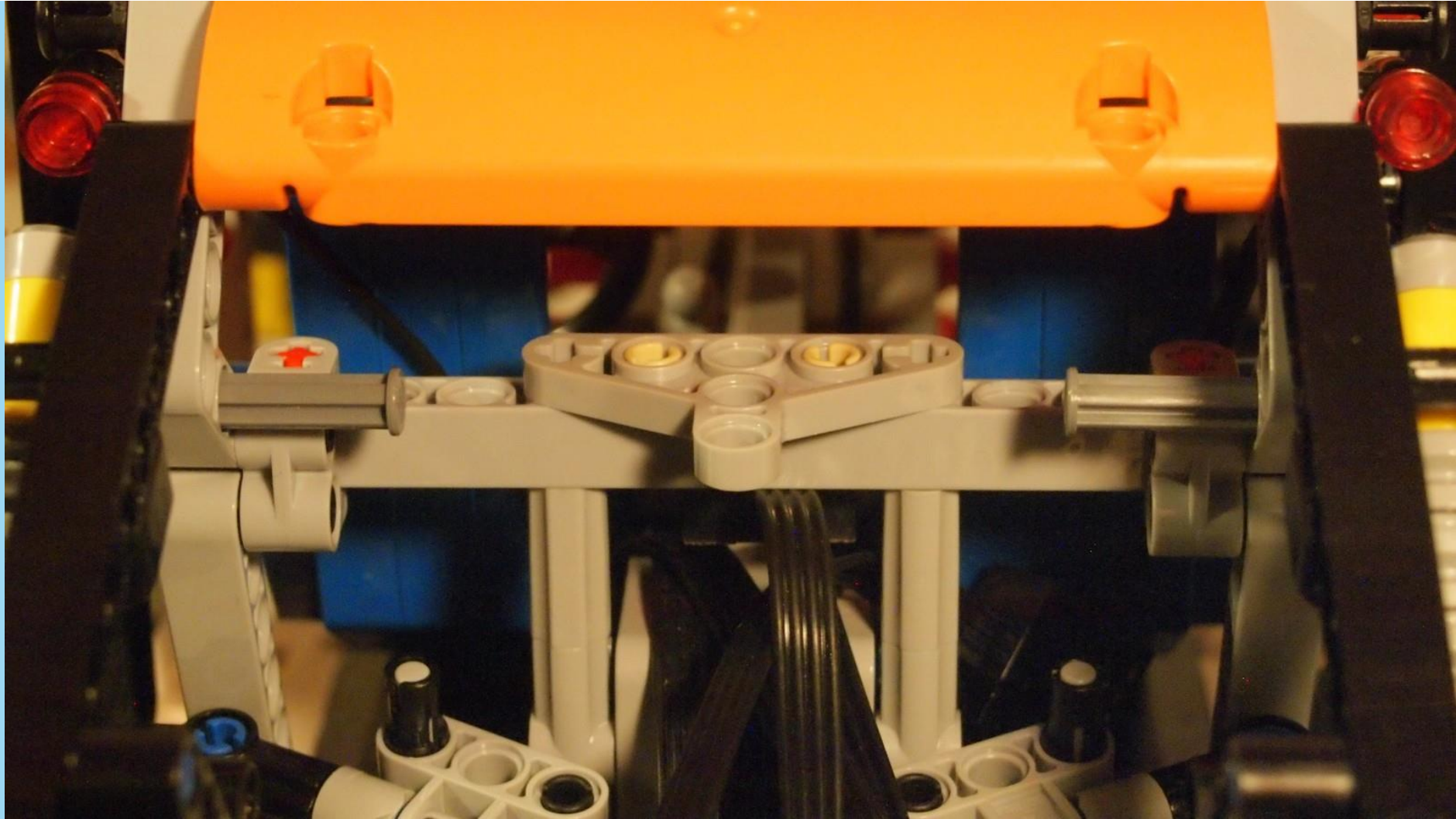

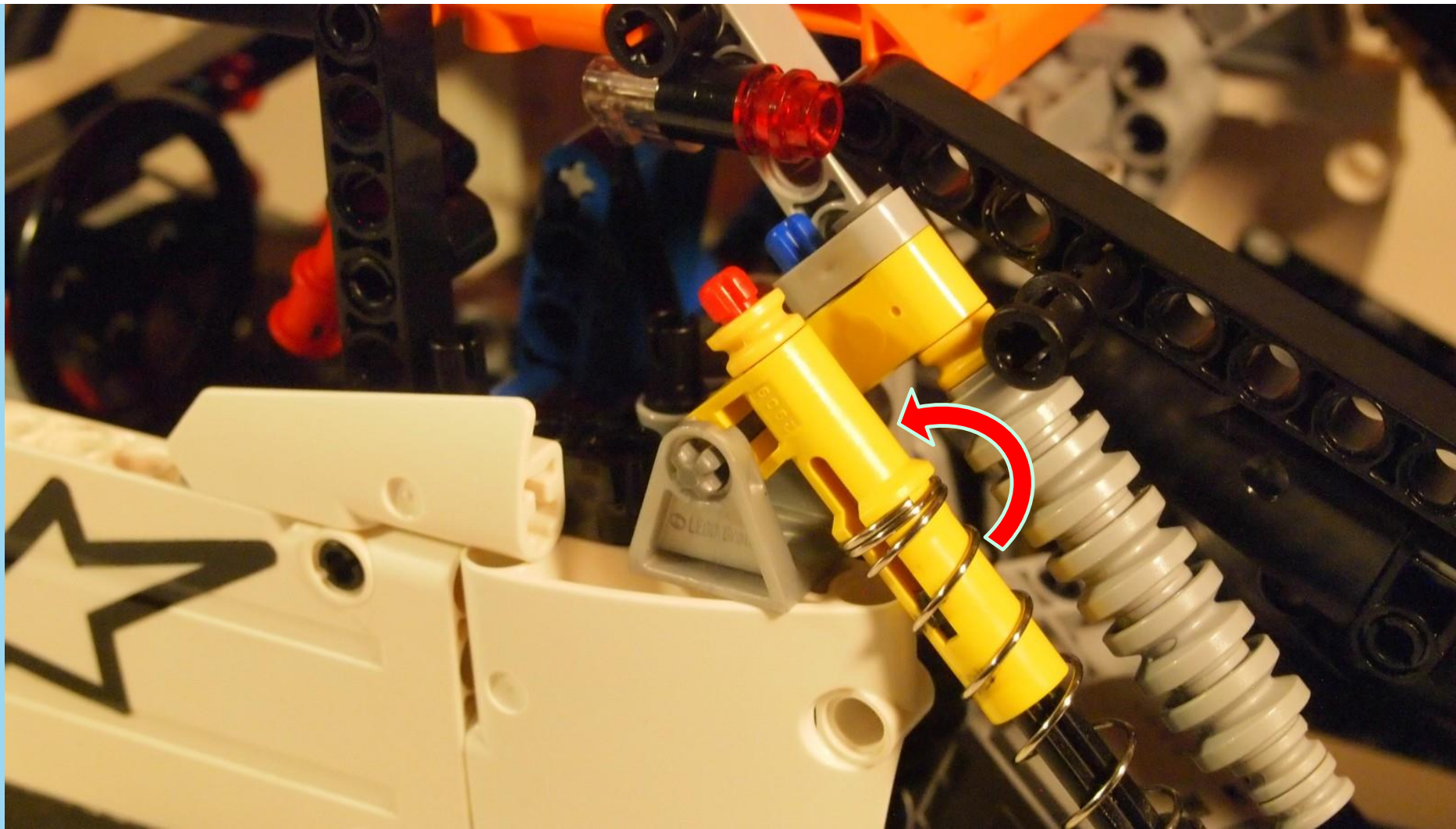

x2

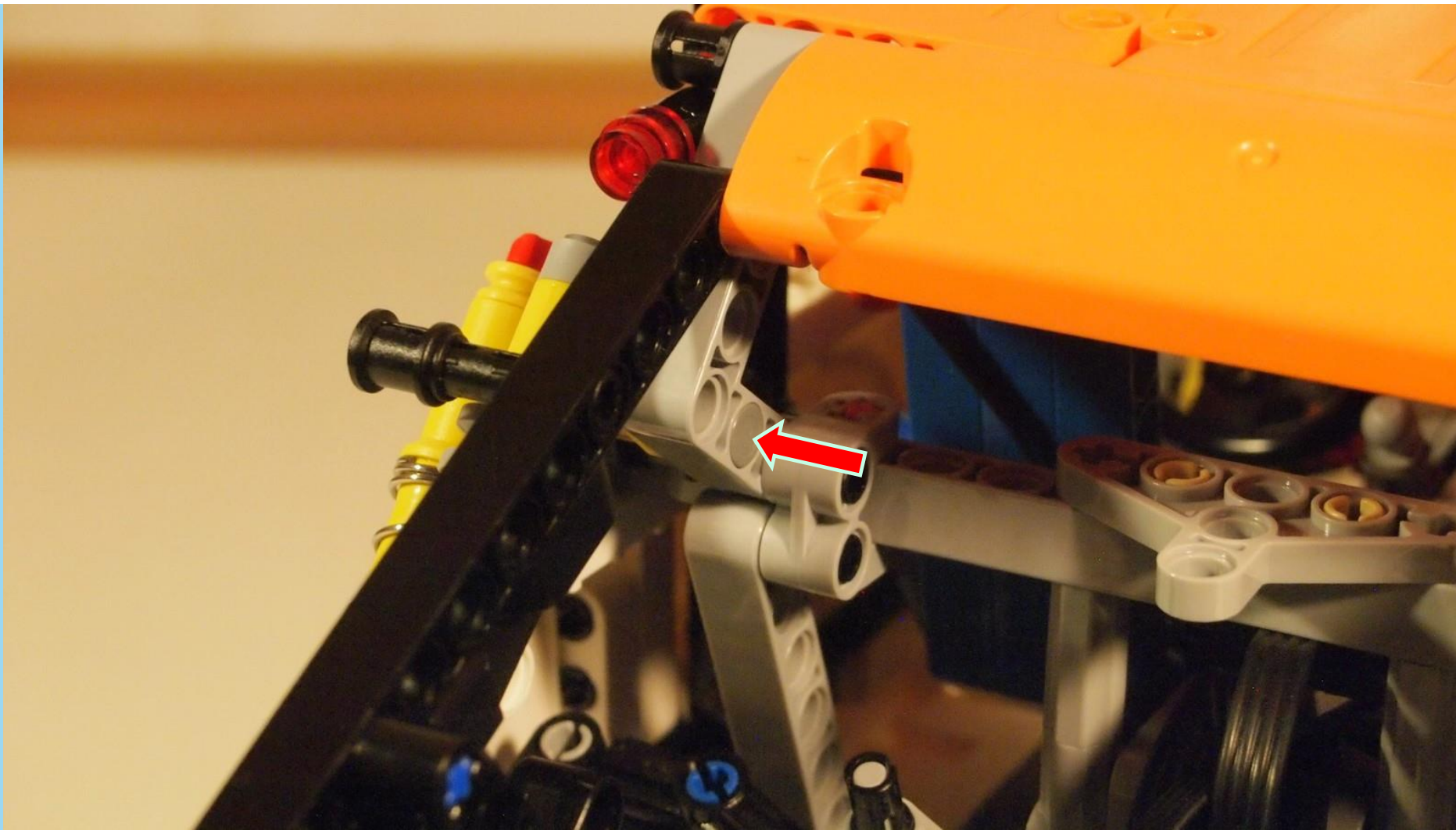

x2



4x 56908



4x RC4WD 1.55 Mud Thrashers

alternative



4x 15038



4x 92912

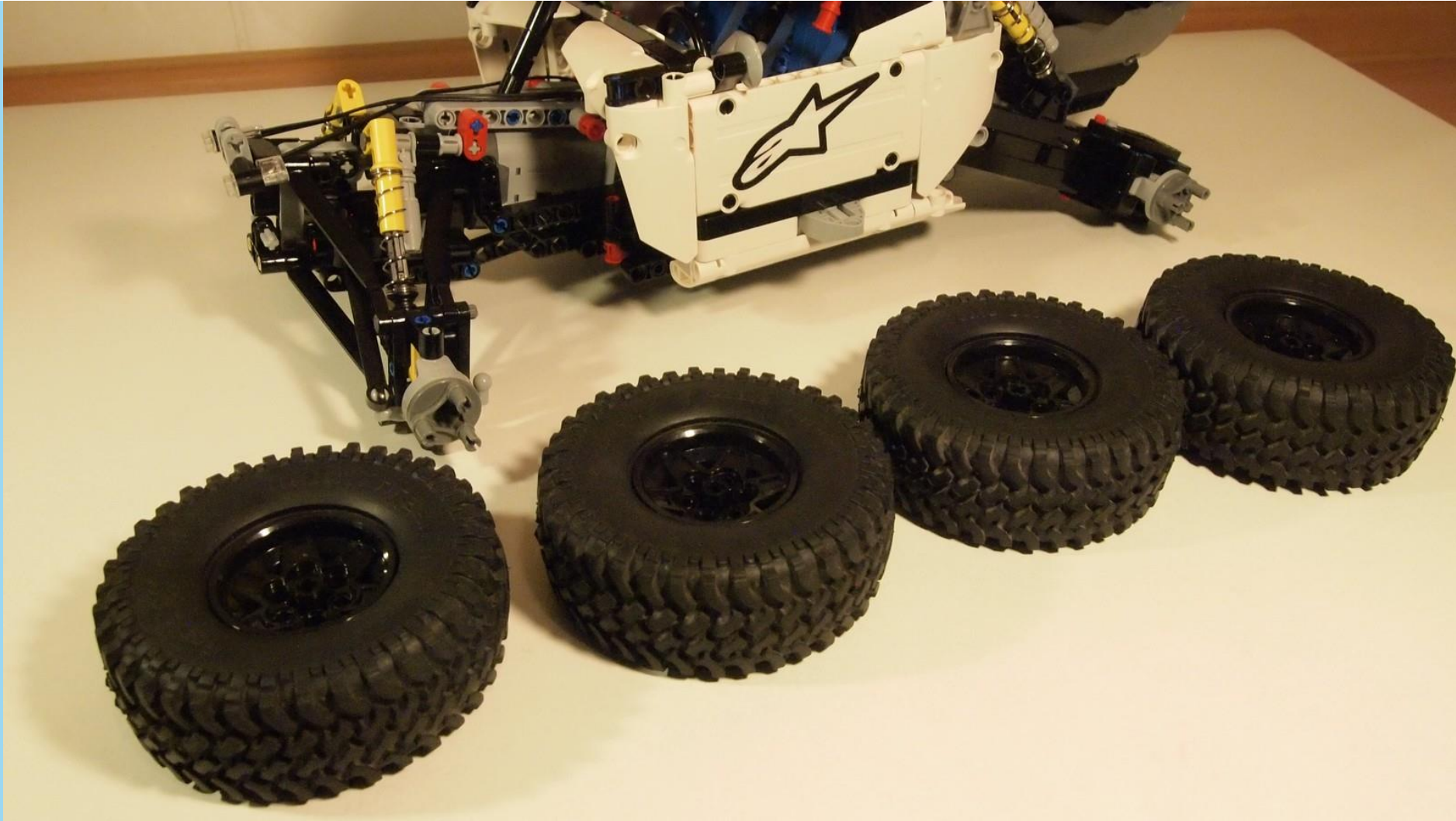



3x



1x



x4



4x



2x



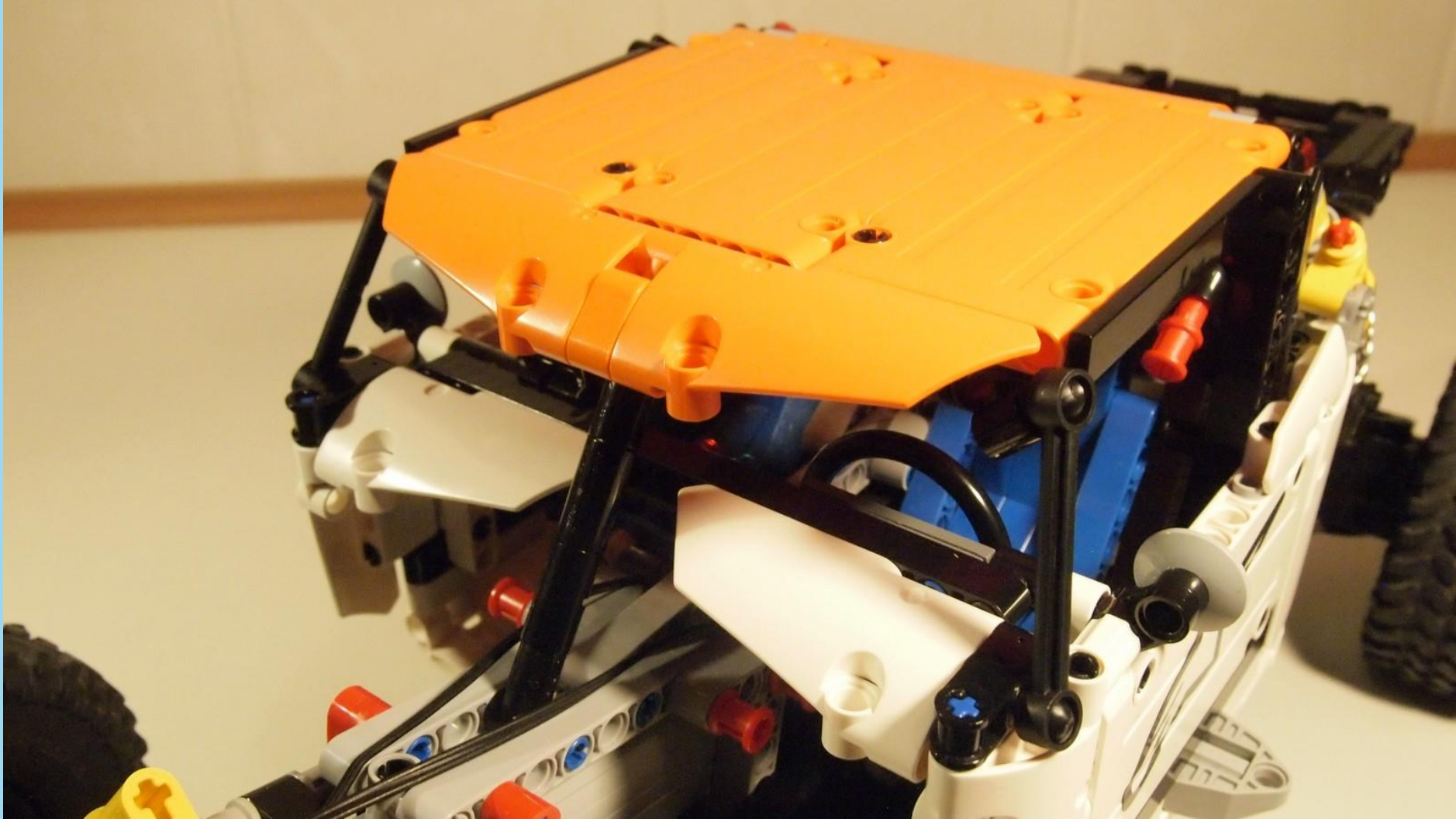



1x



1x

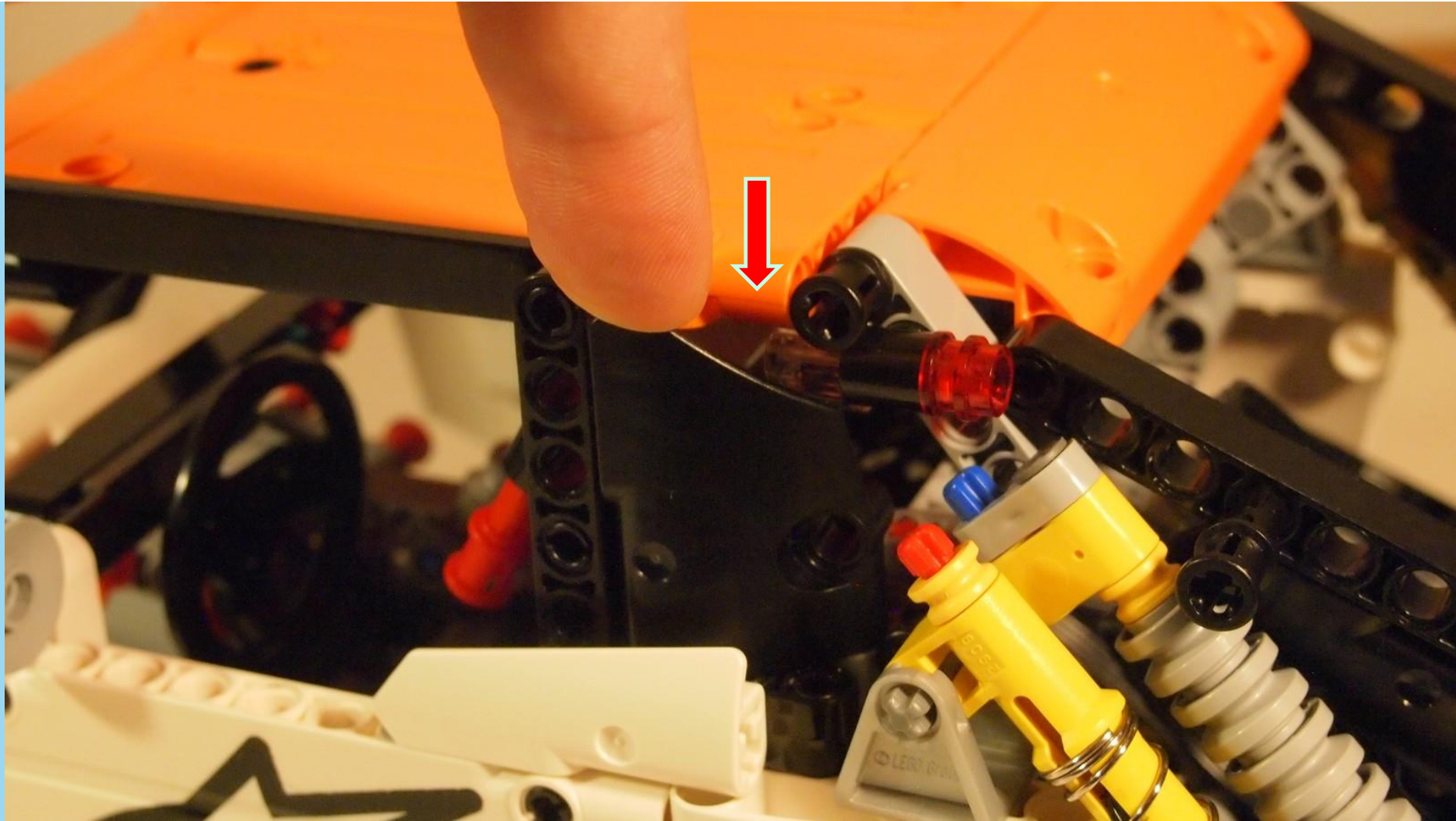

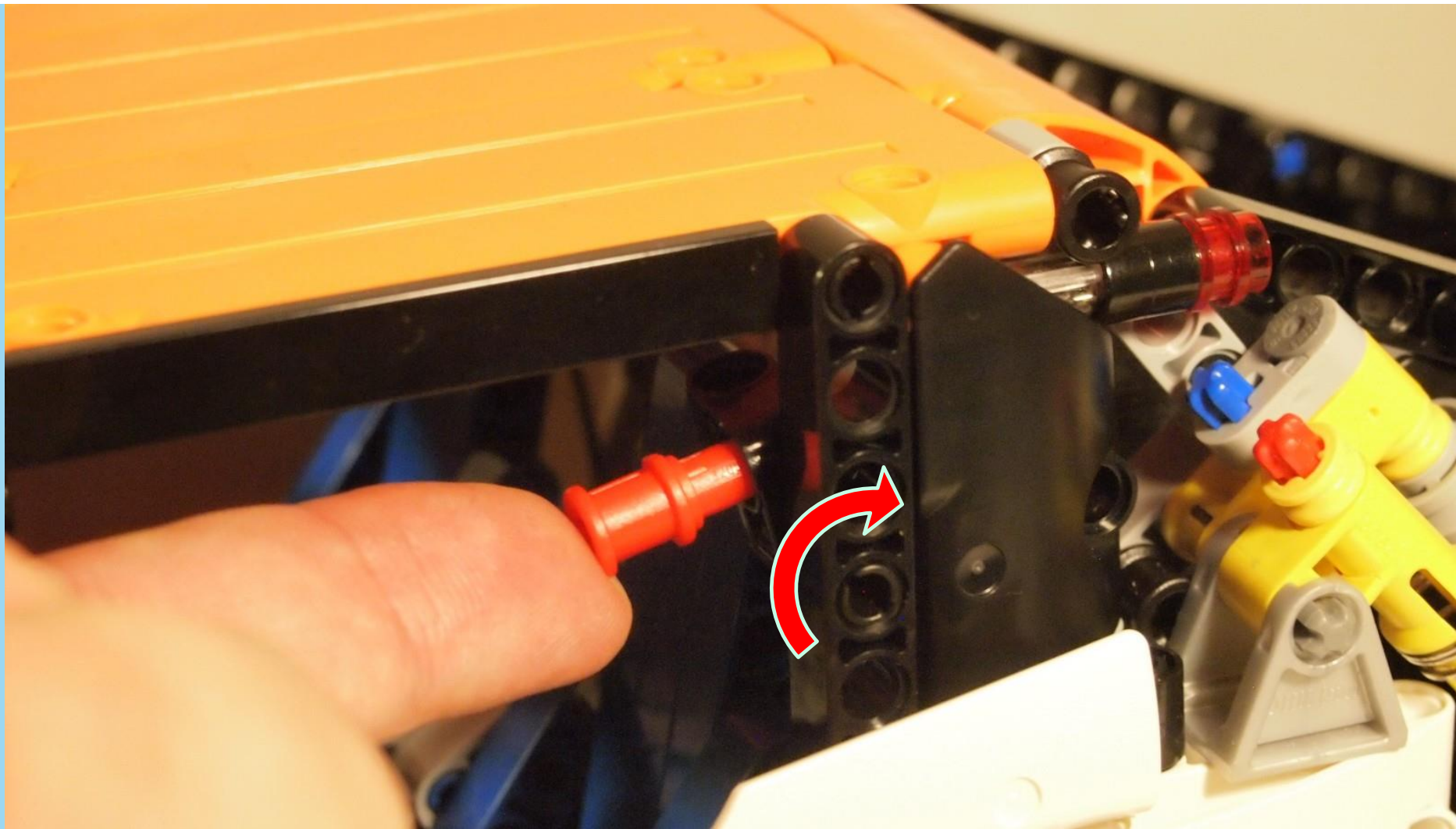

x2



Use an axle to push
in position!

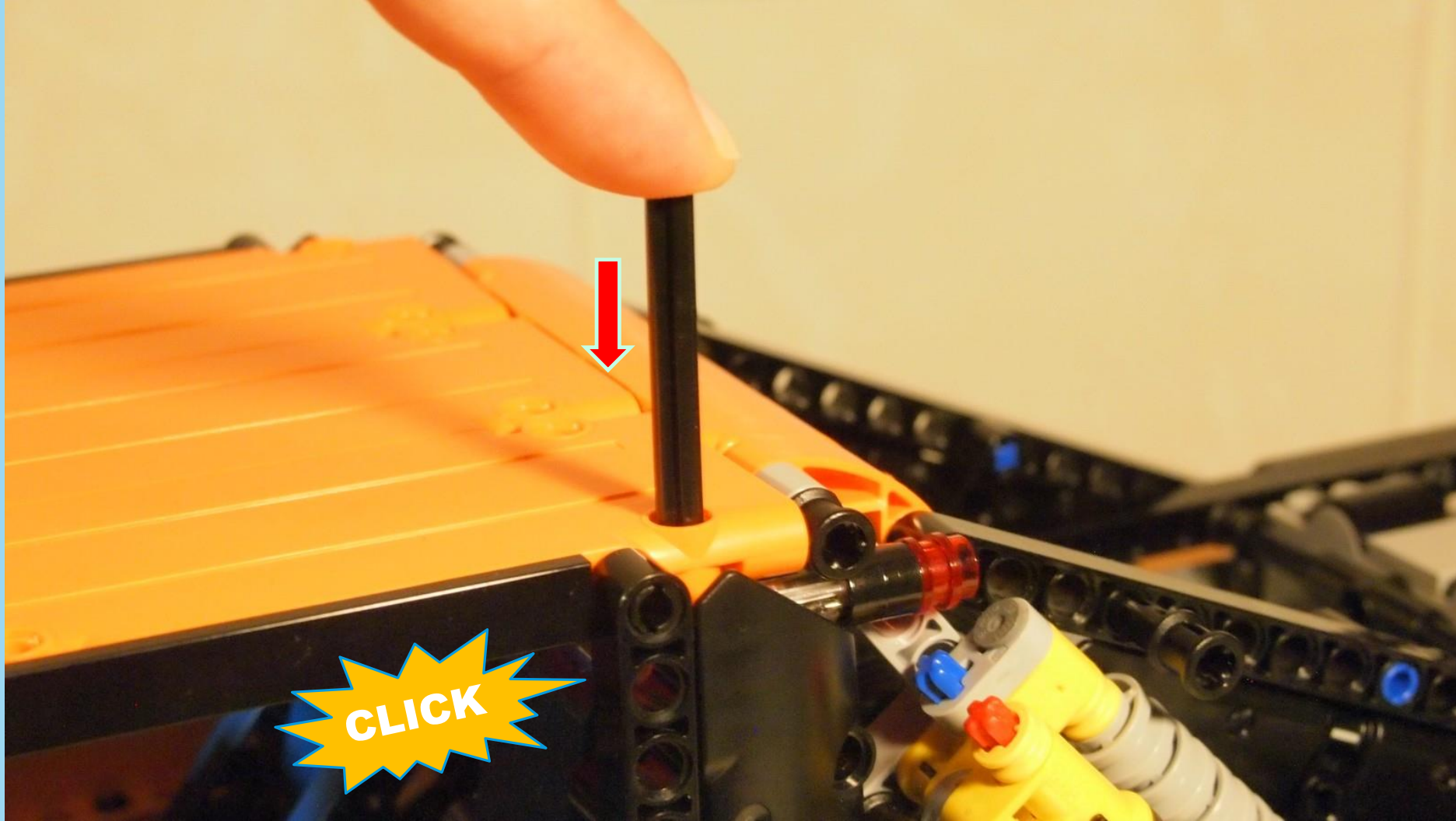

x2

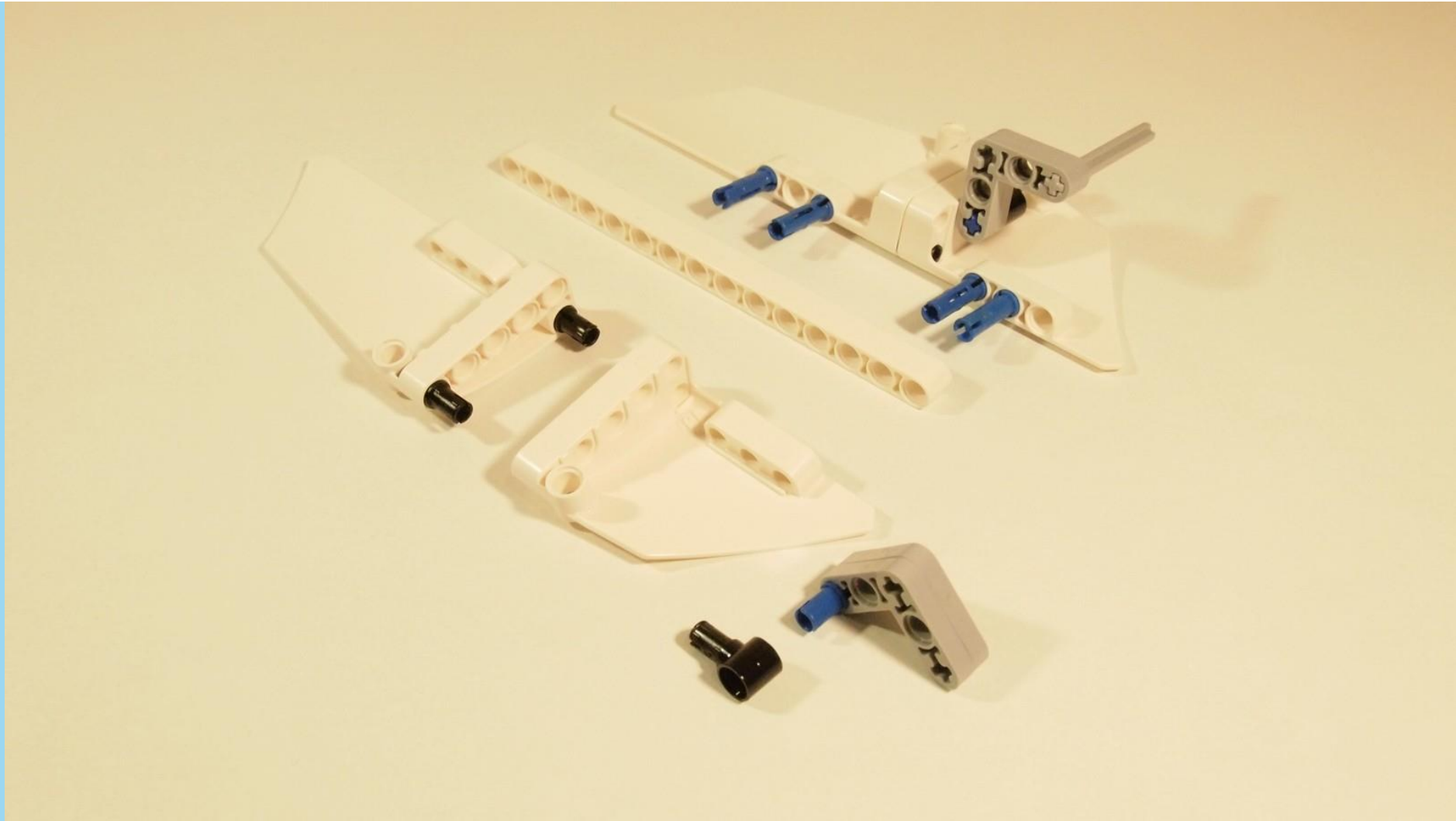
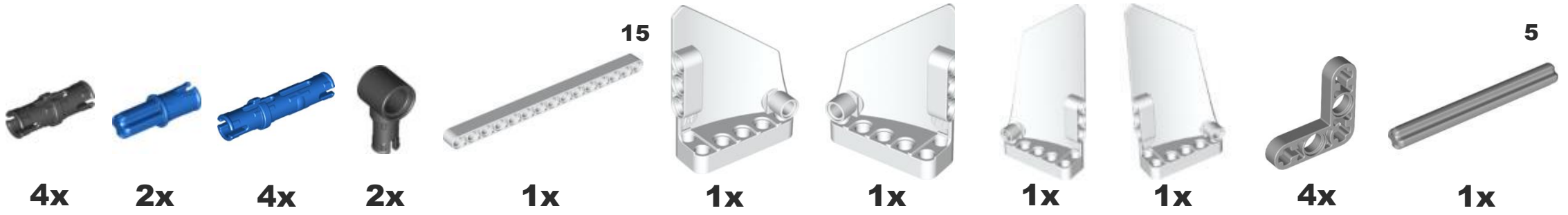

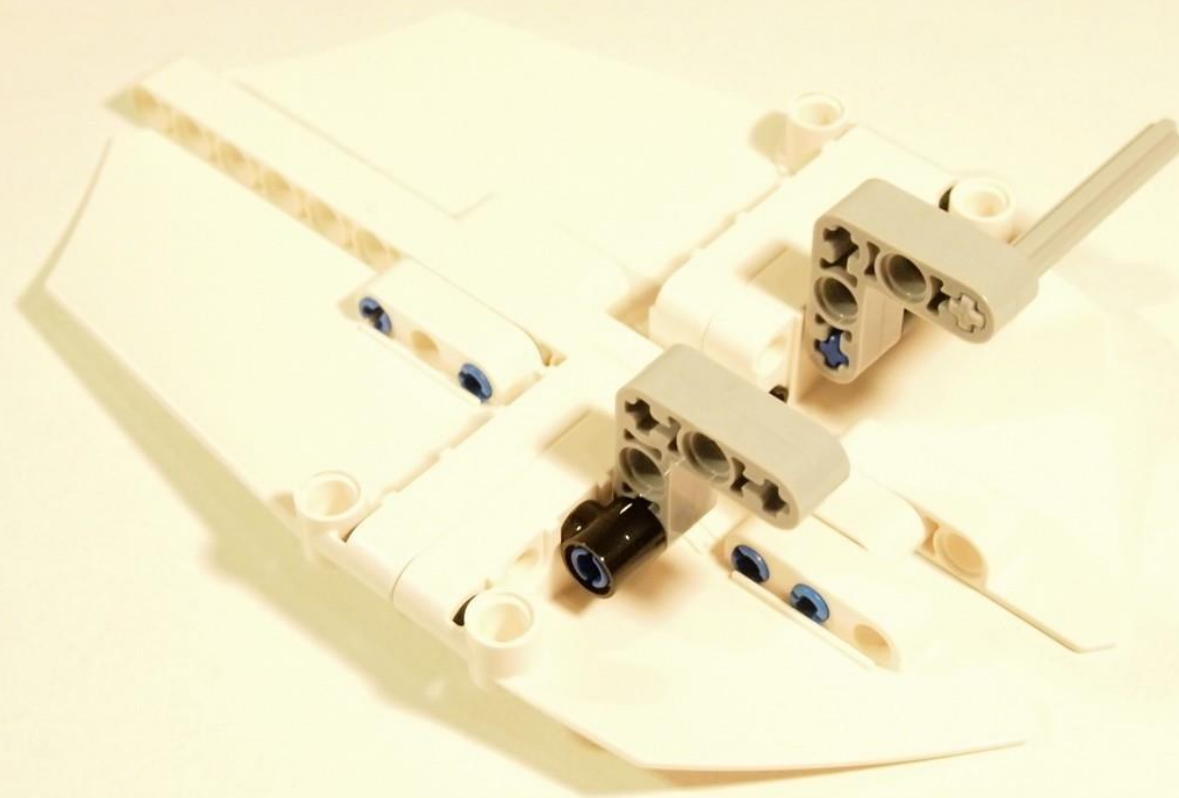

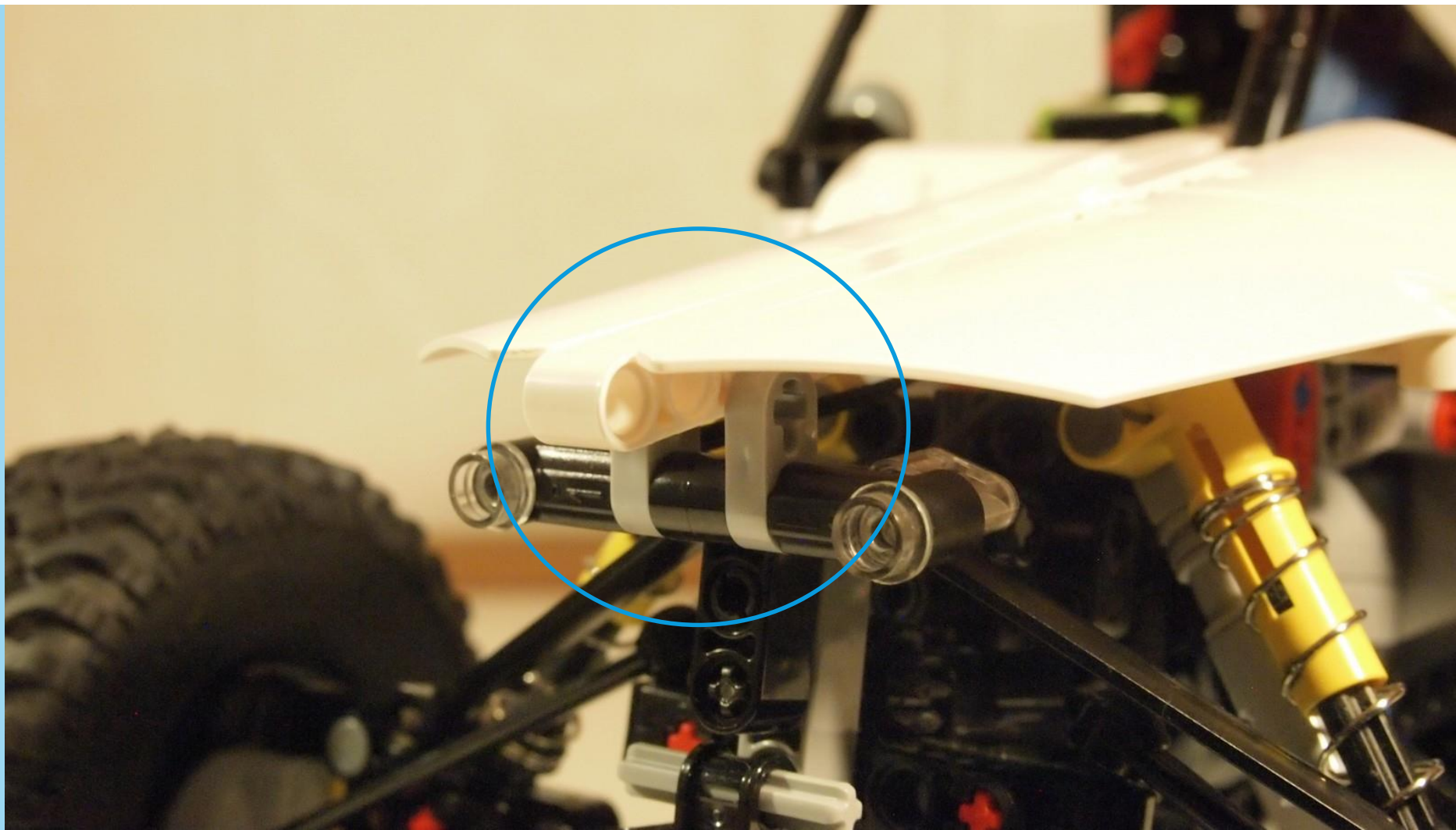

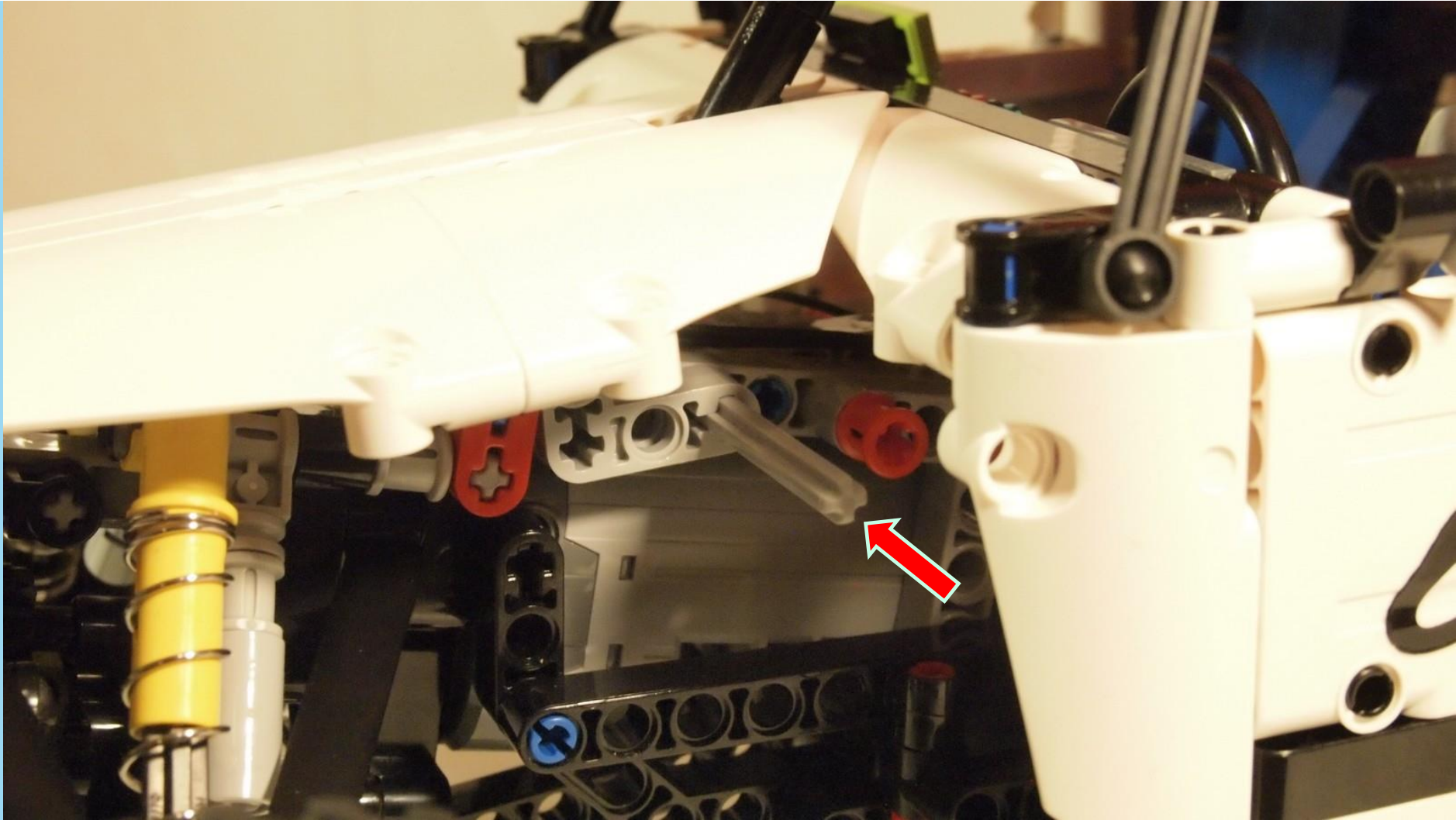



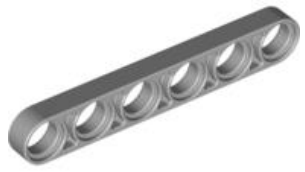

2x



2x

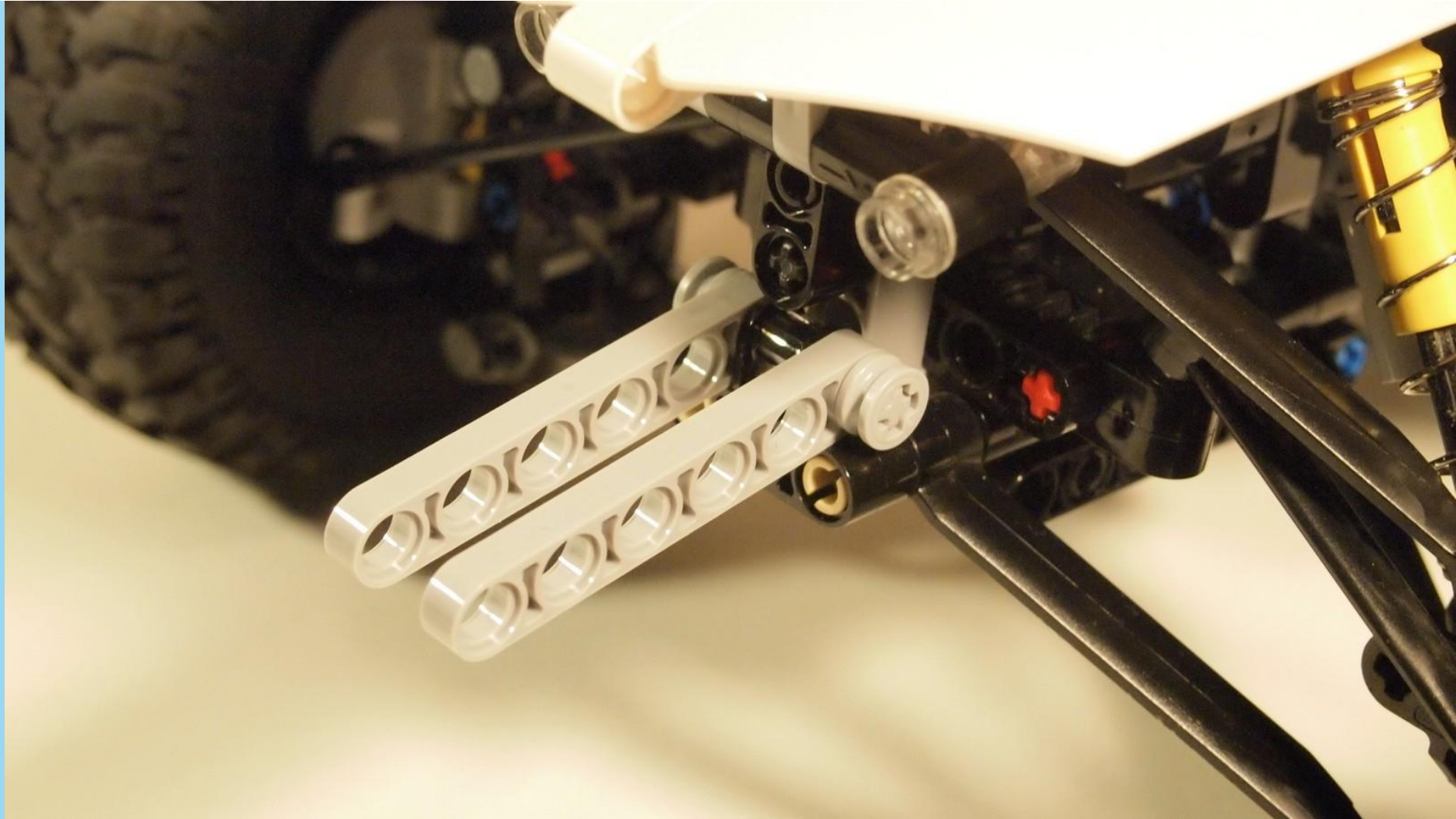

6



1x



2x



color alarm

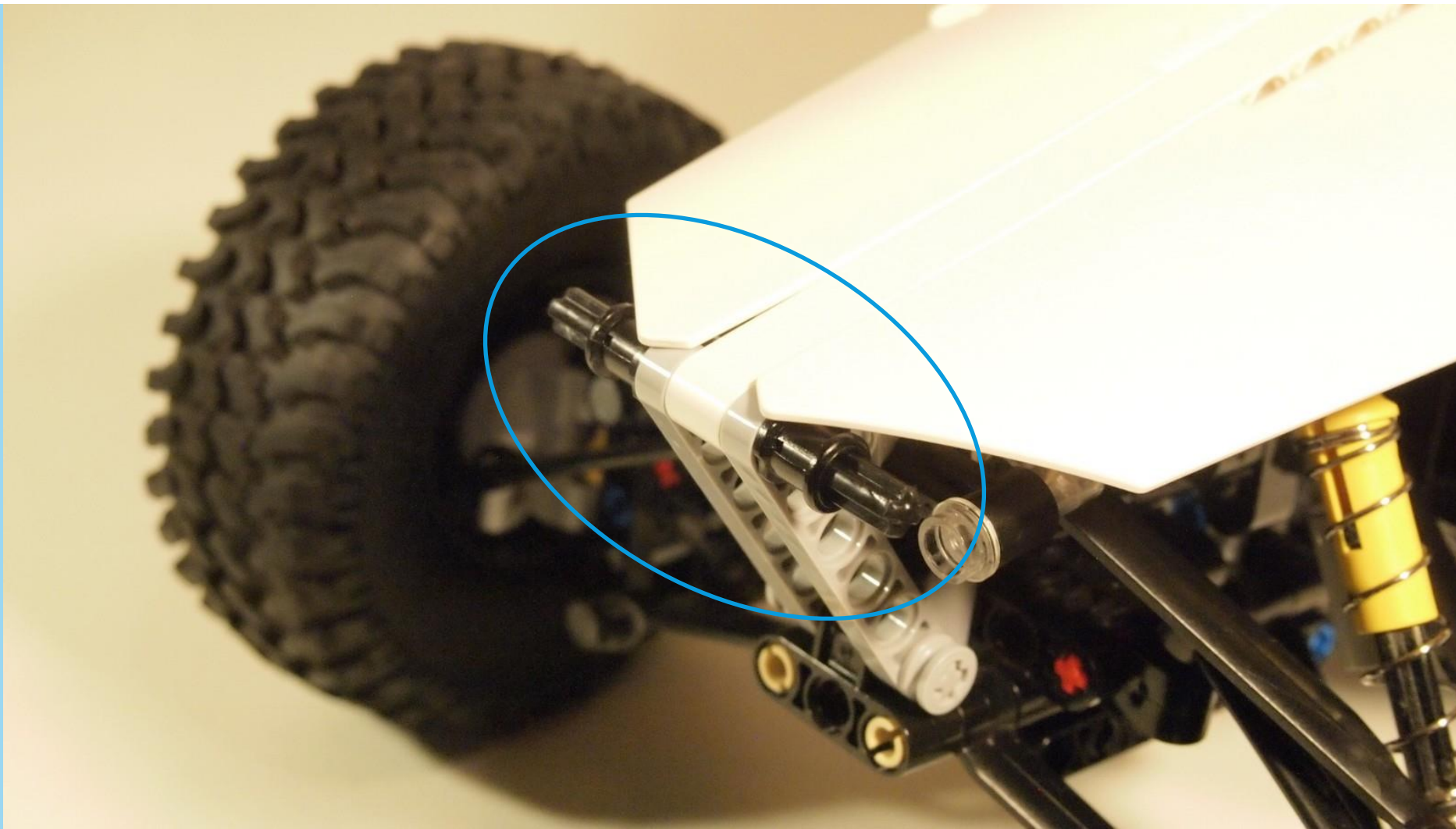



2x



2x



1x



2x



color alarm



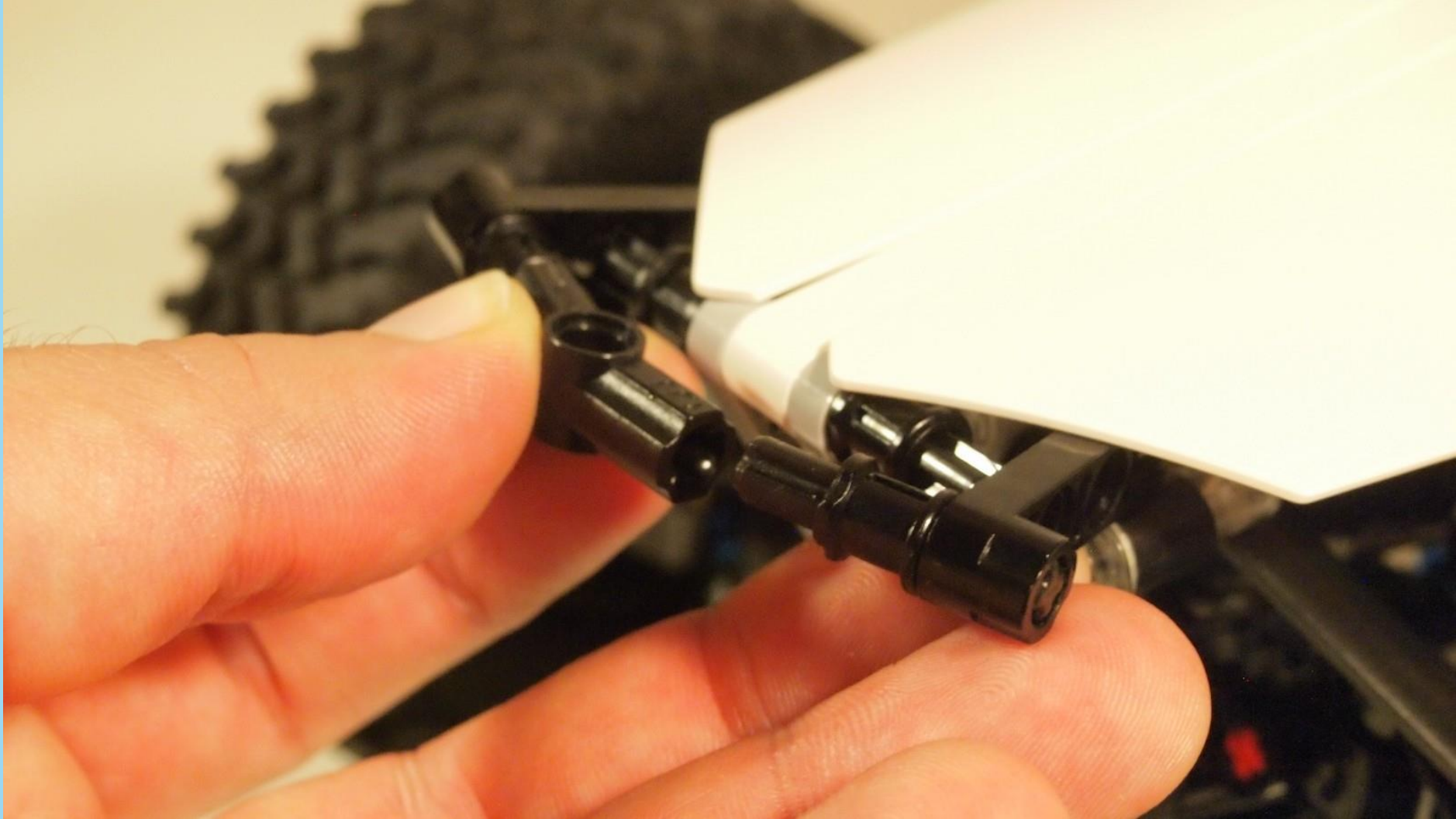



There is some stretch on both sides, illegal, but **needed** here.



CLICK



CLICK

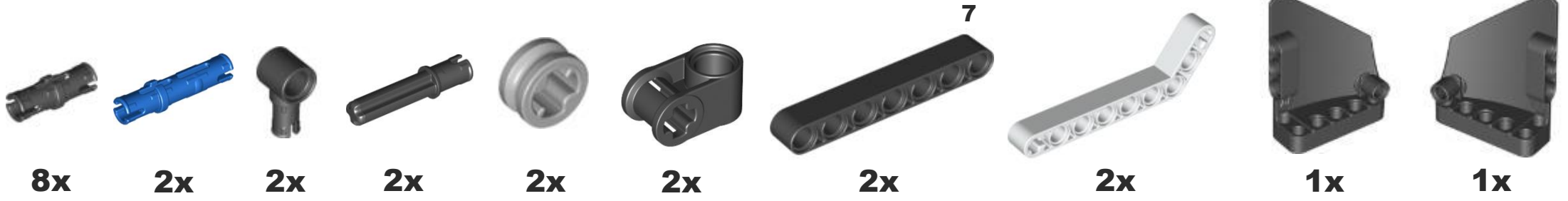

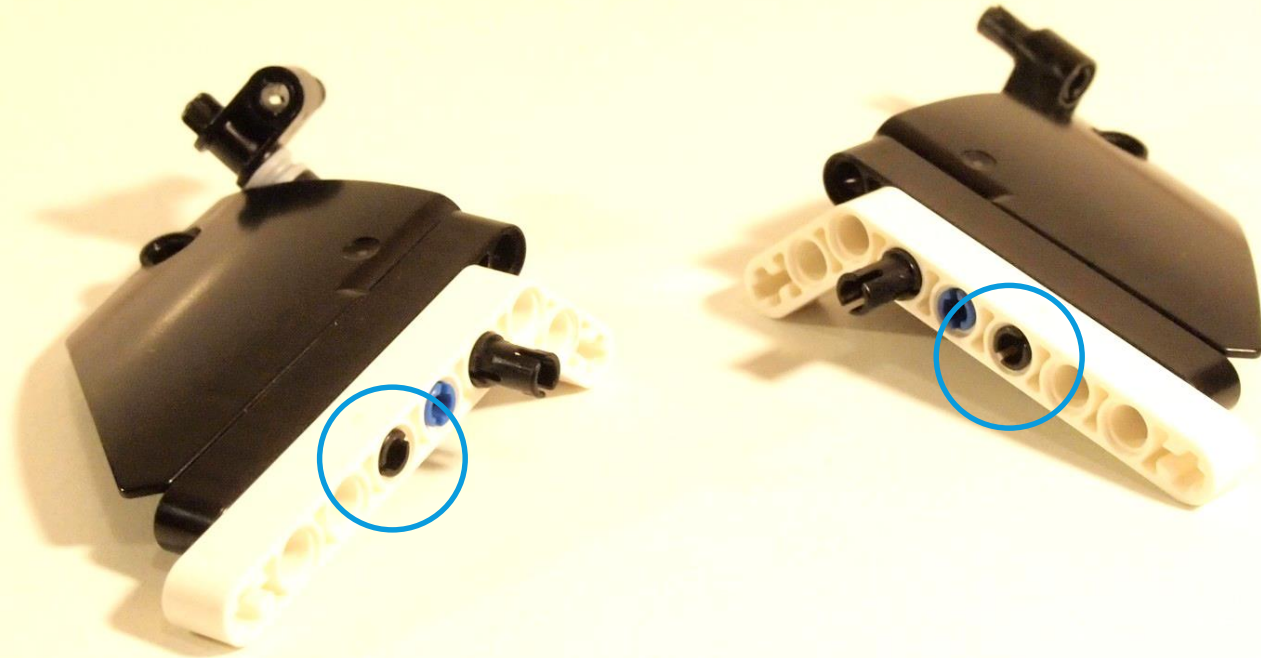



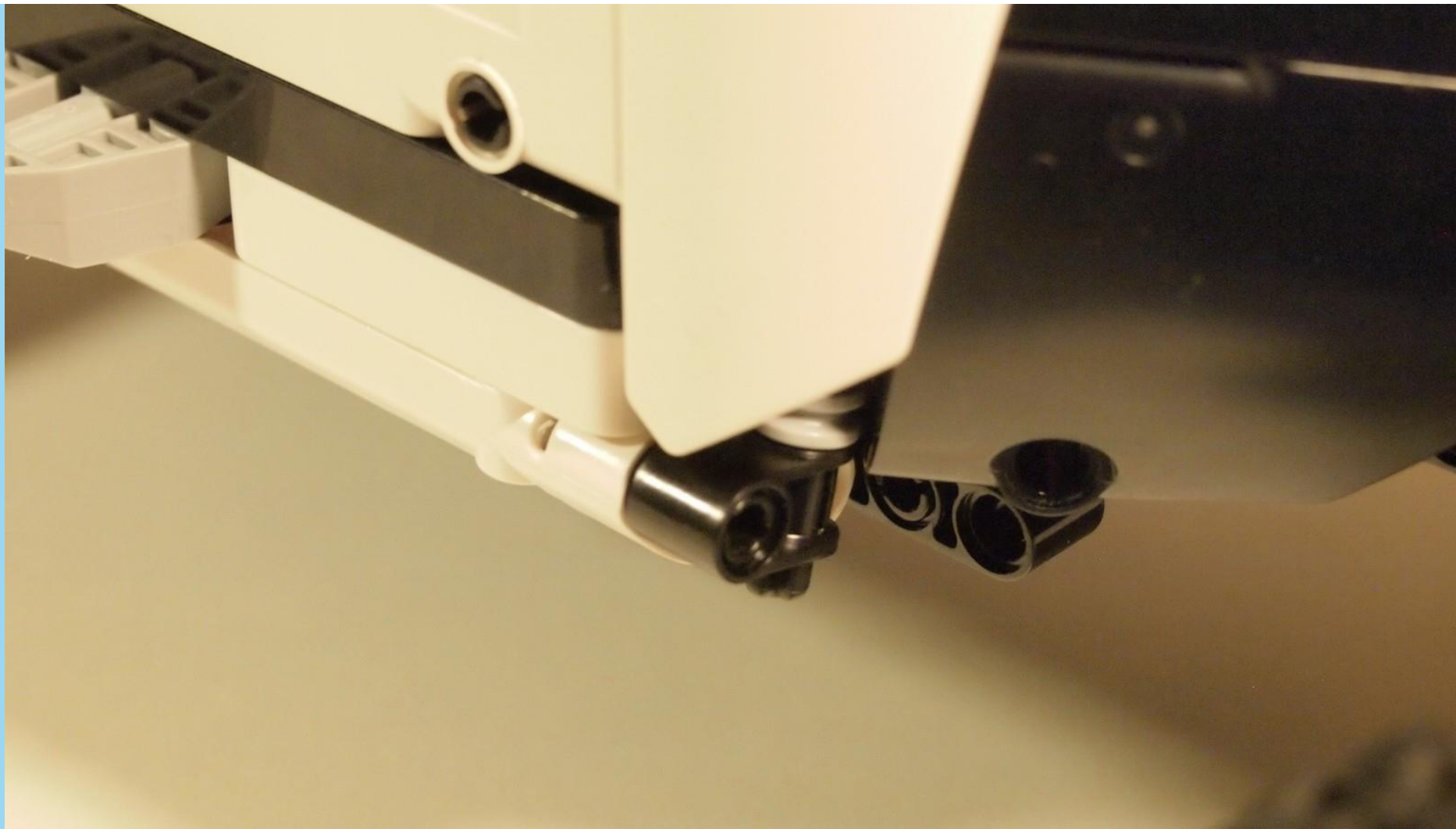



2x

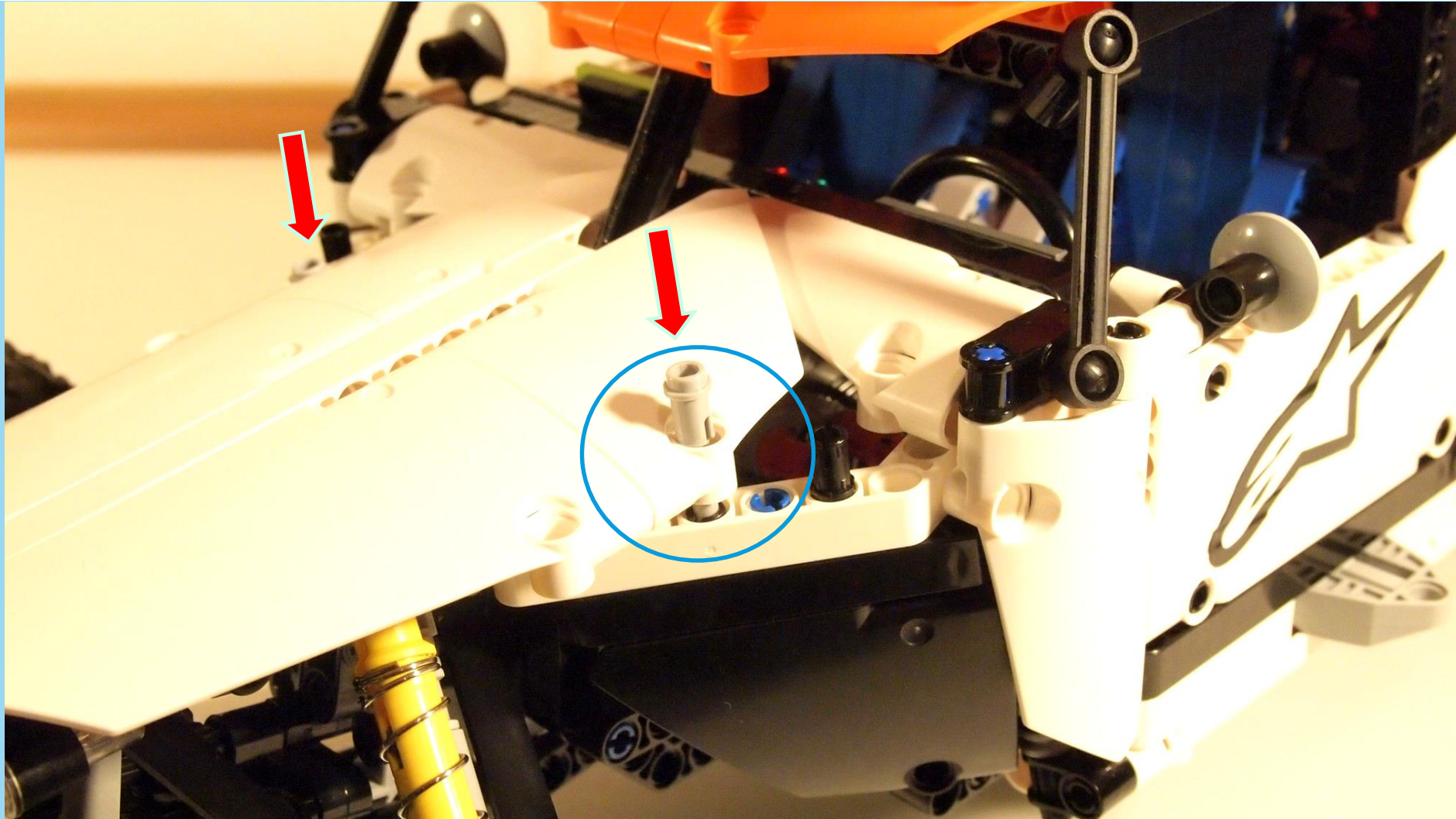

3



2x

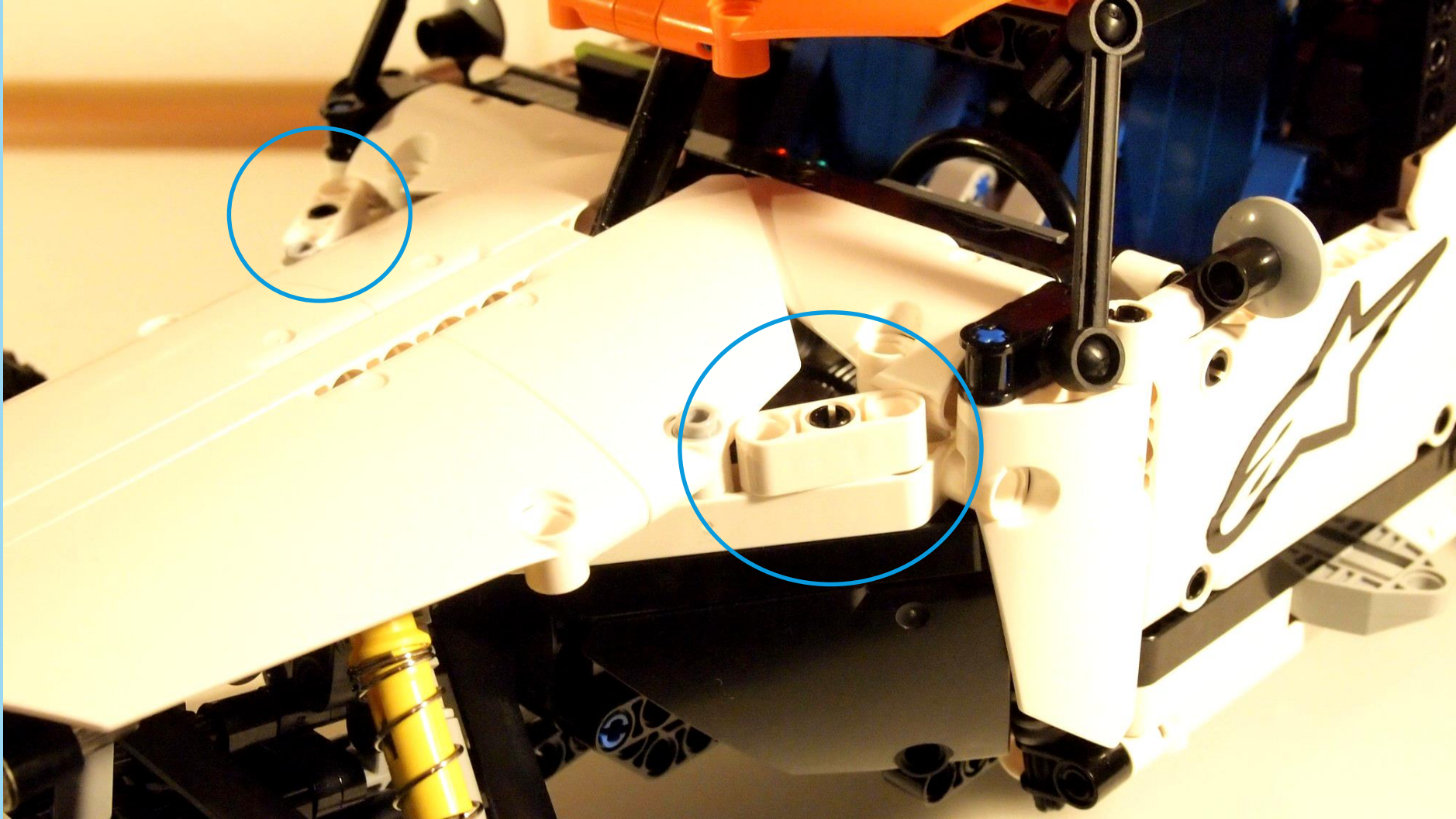

15



1x



2x



2x



1x



1x



6x



2x



color alarm

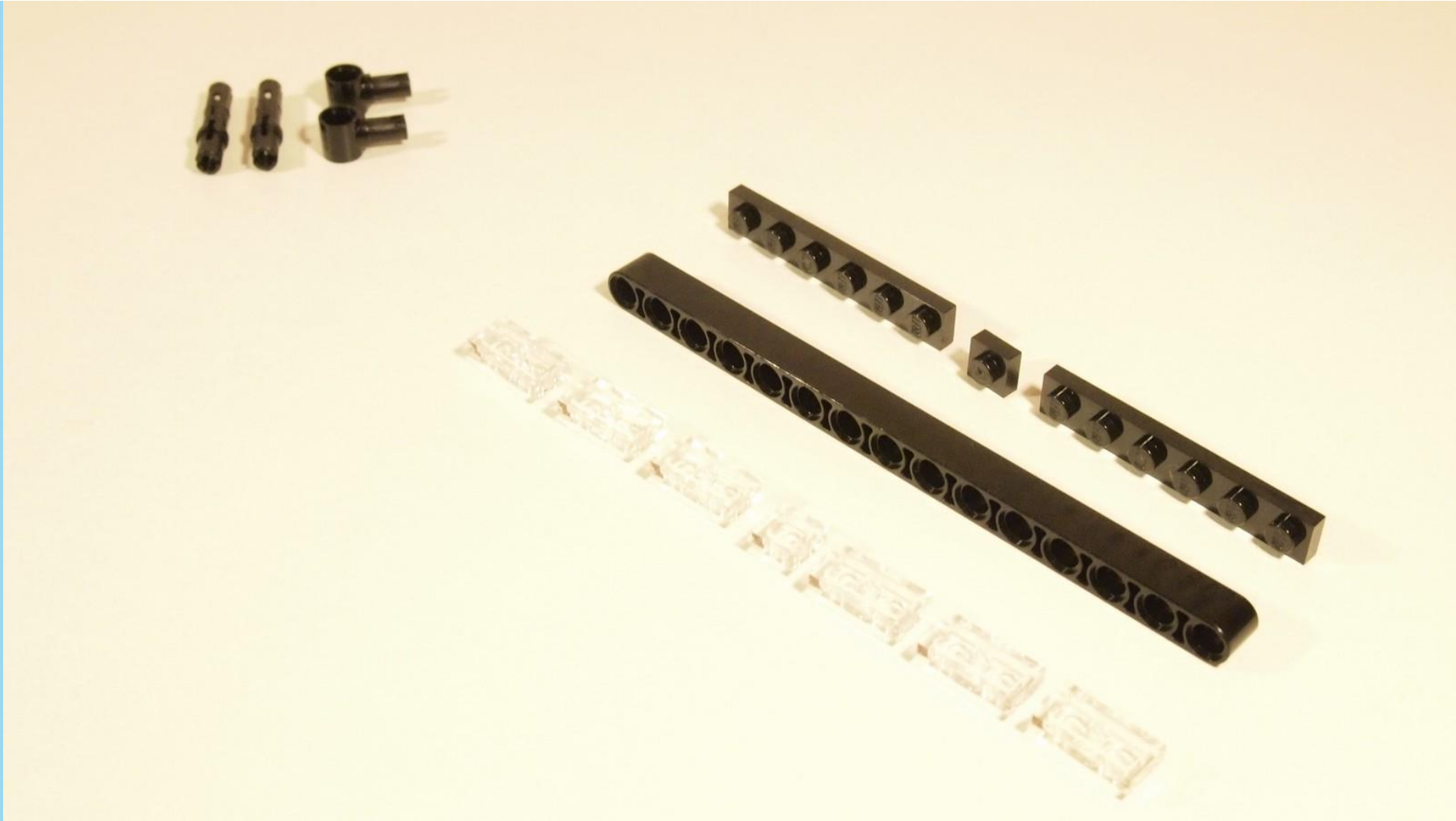



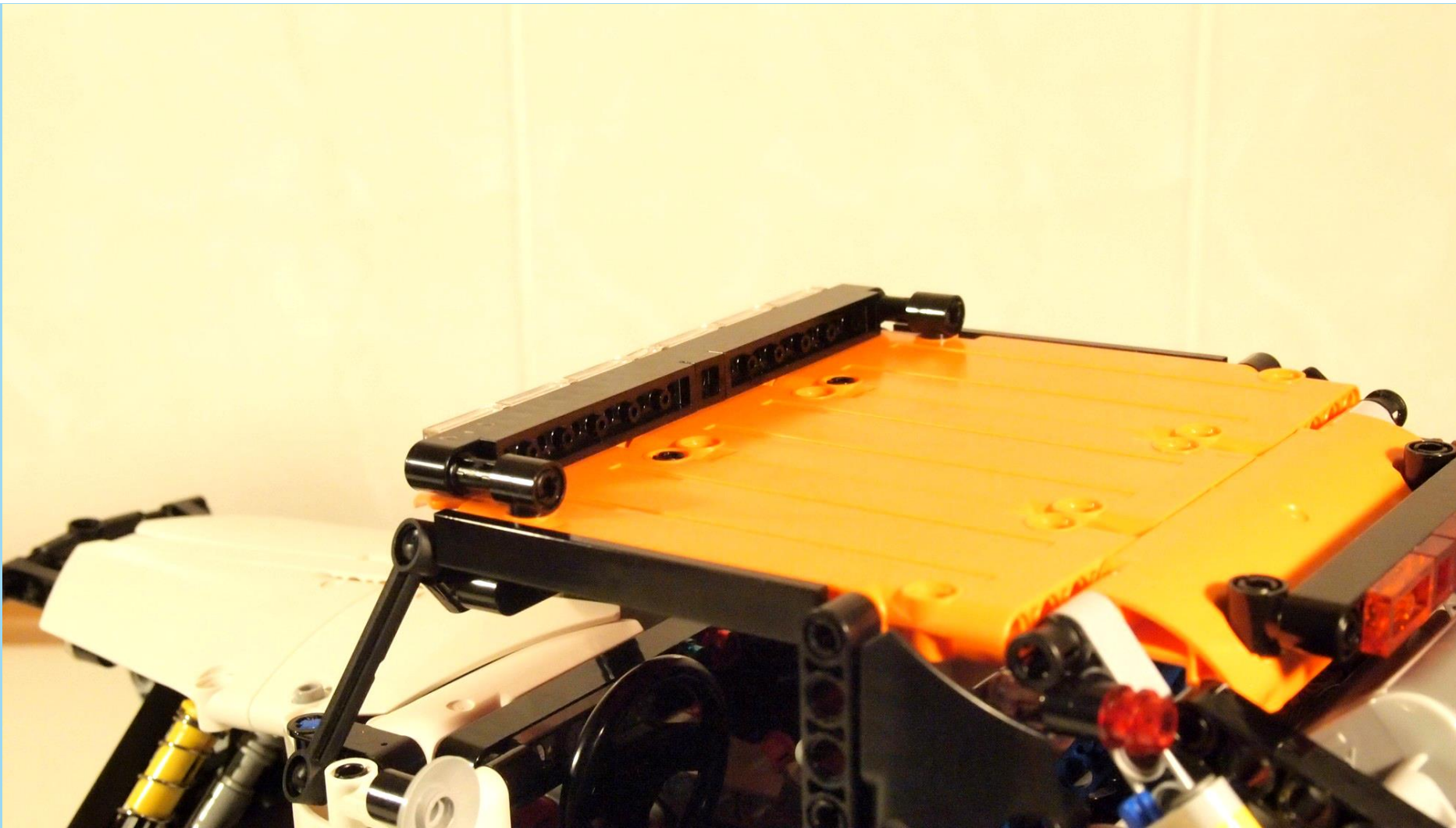

9



1x



2x



2x

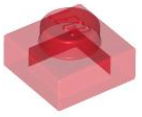

3x

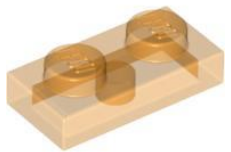

2x

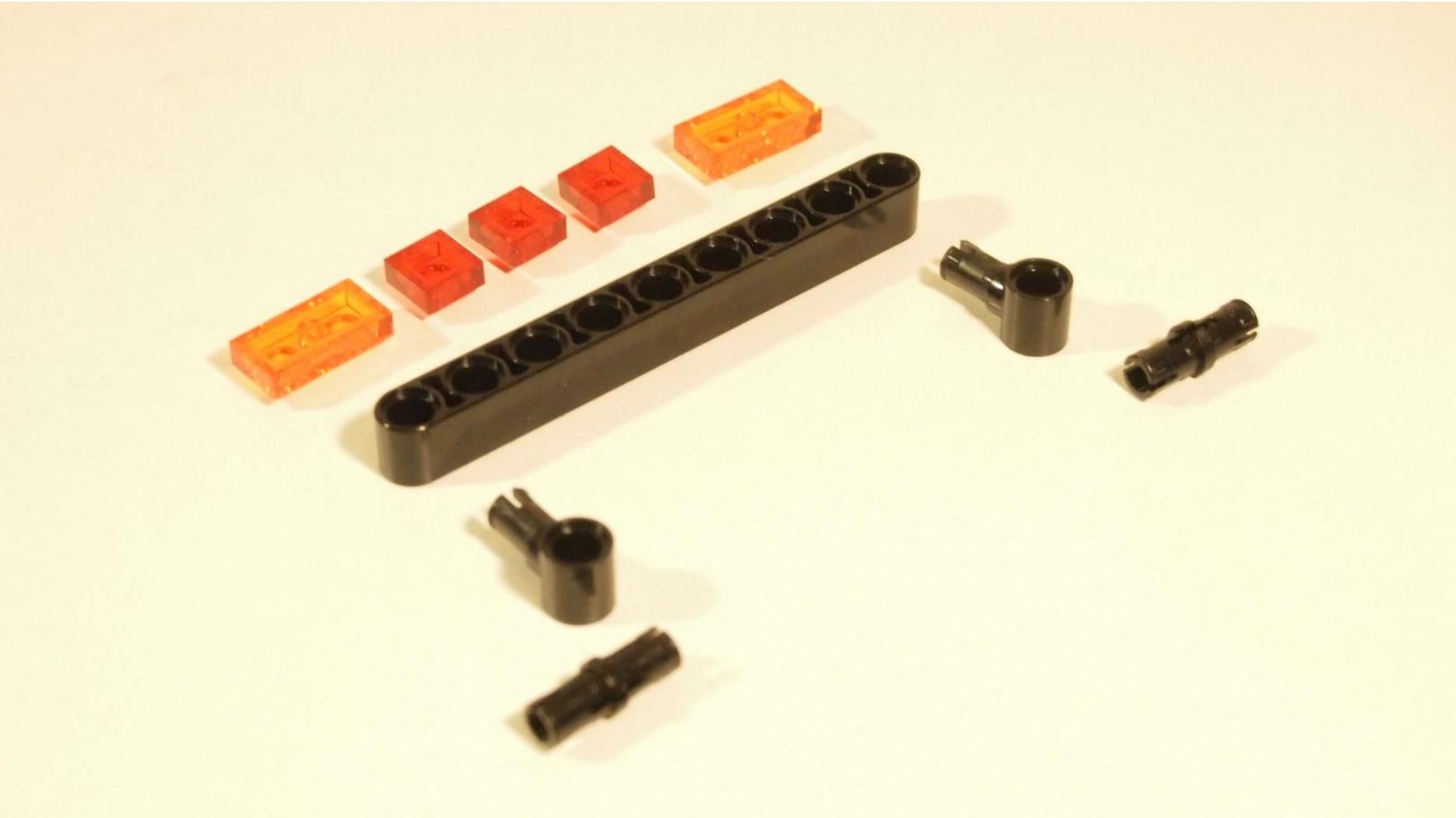



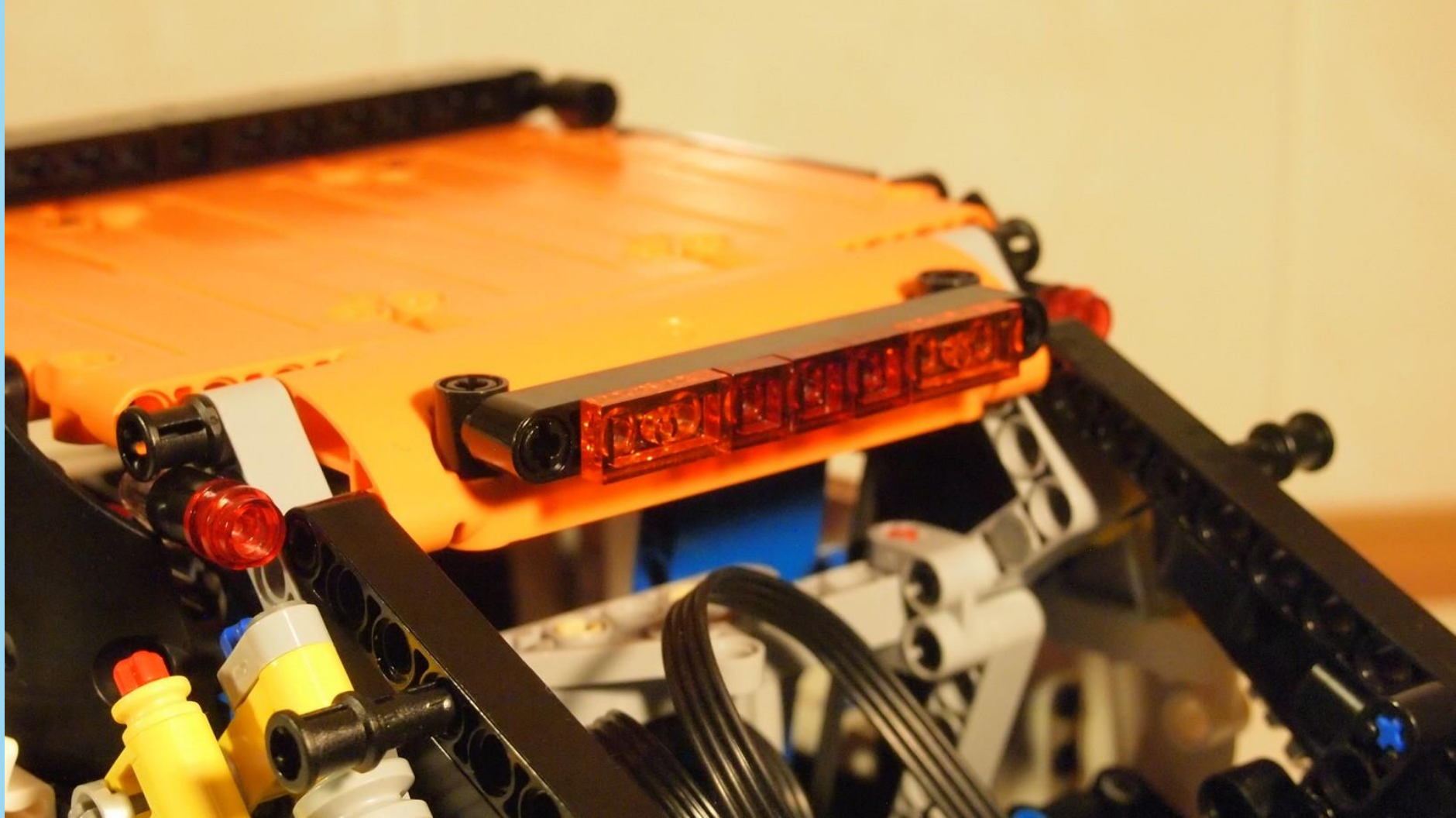



2x



2x



2x



2x



2x



2x

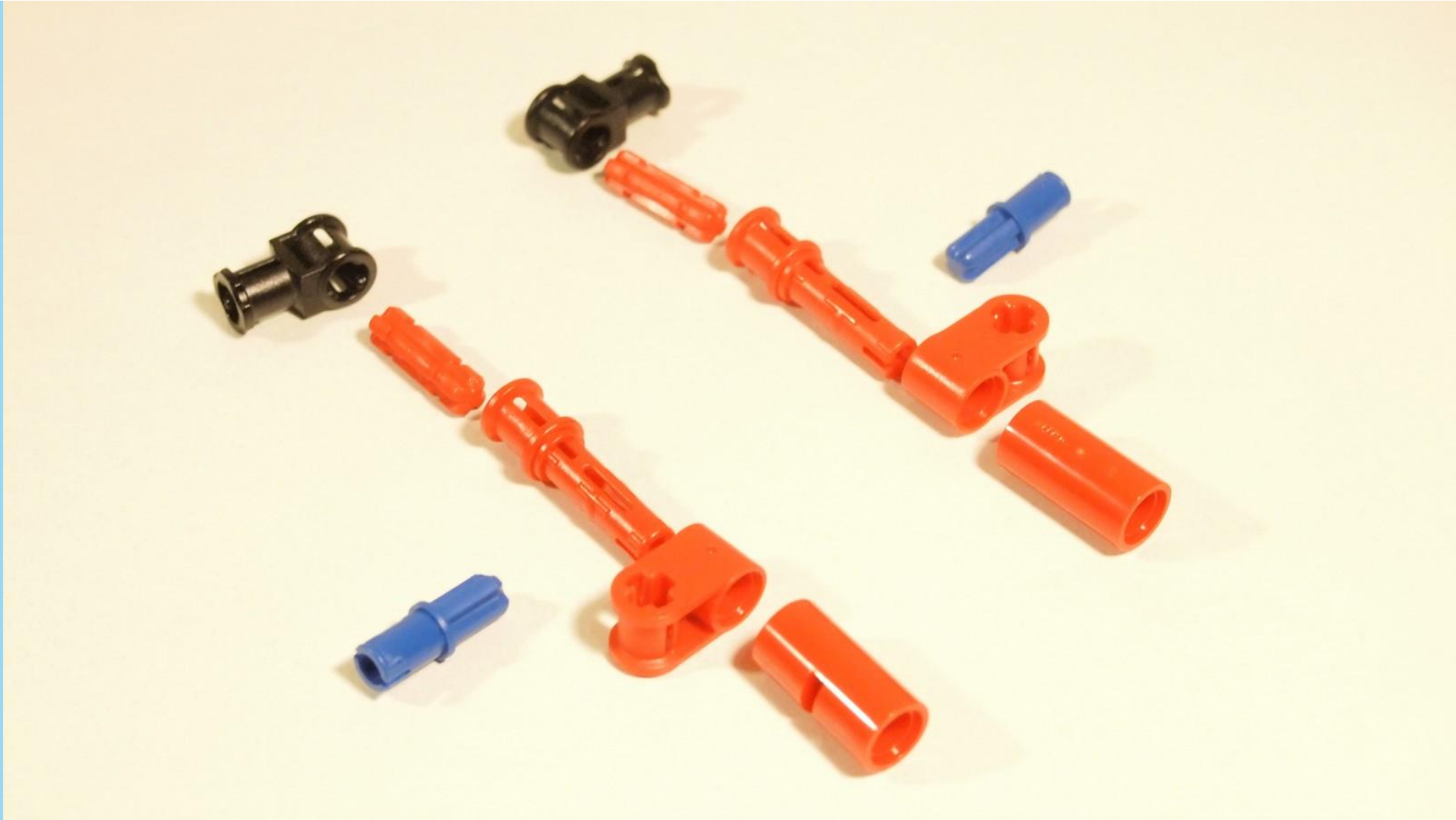



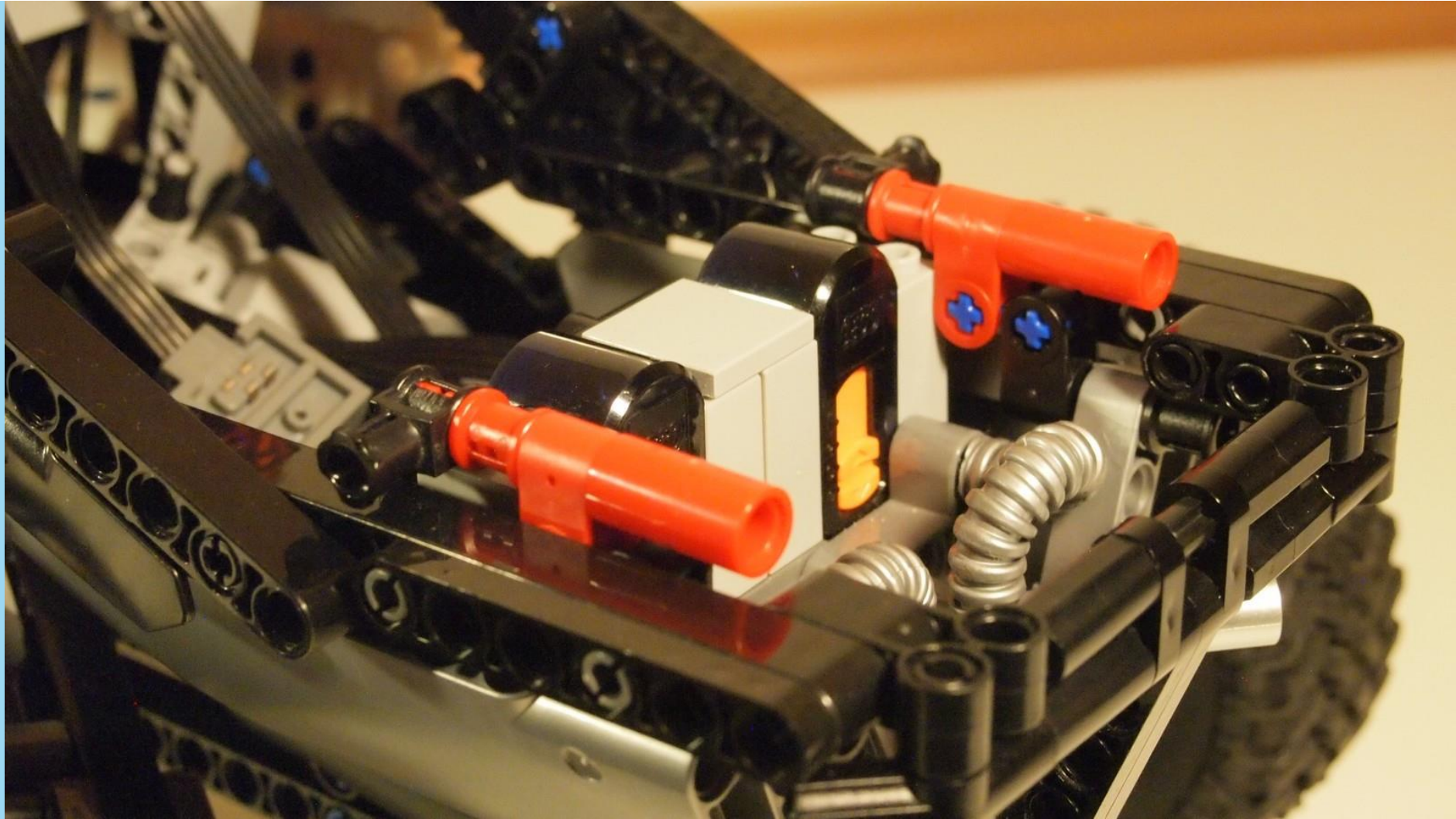

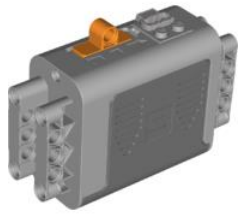

1x



1x



1x

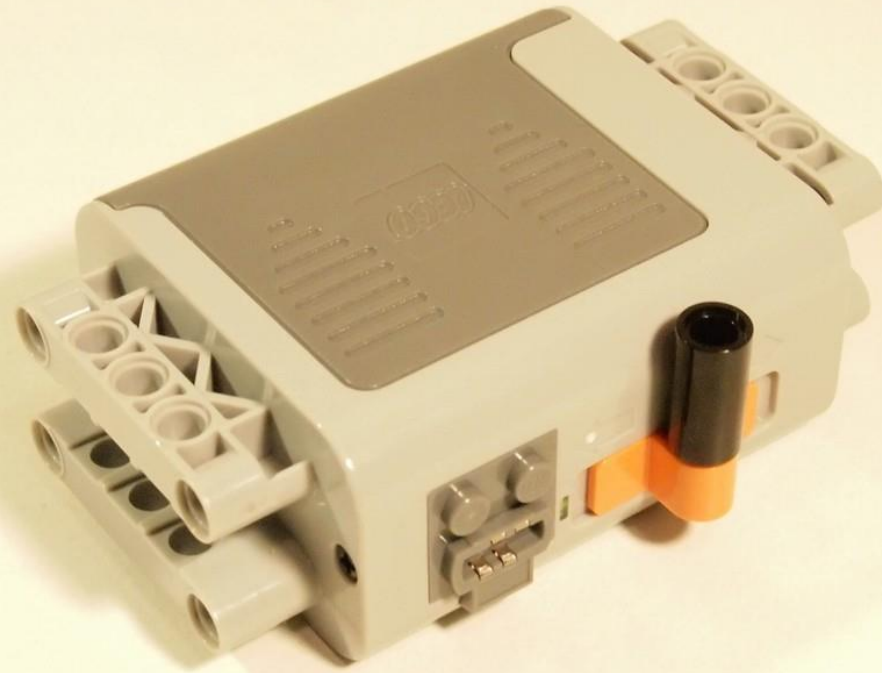

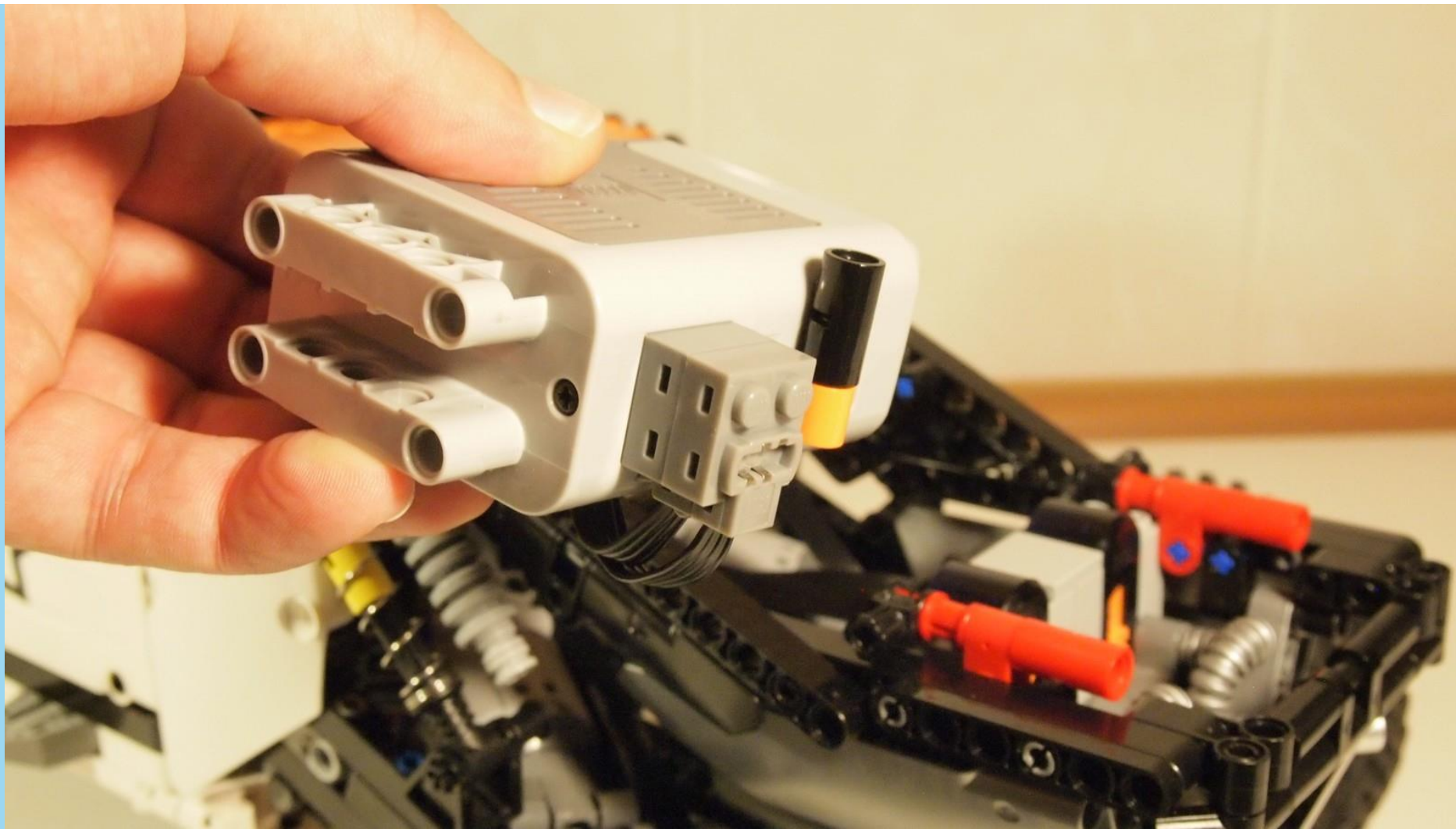

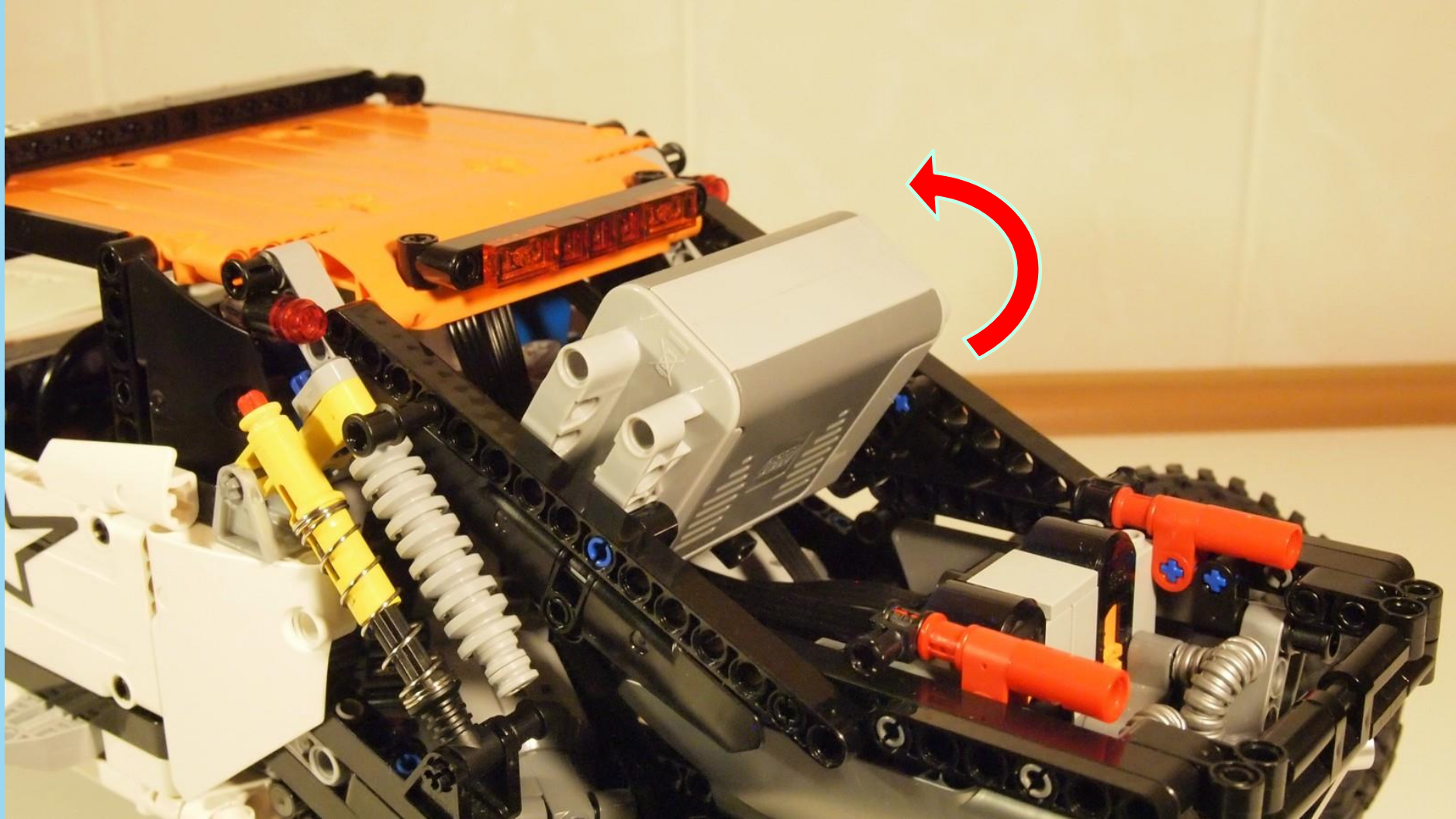

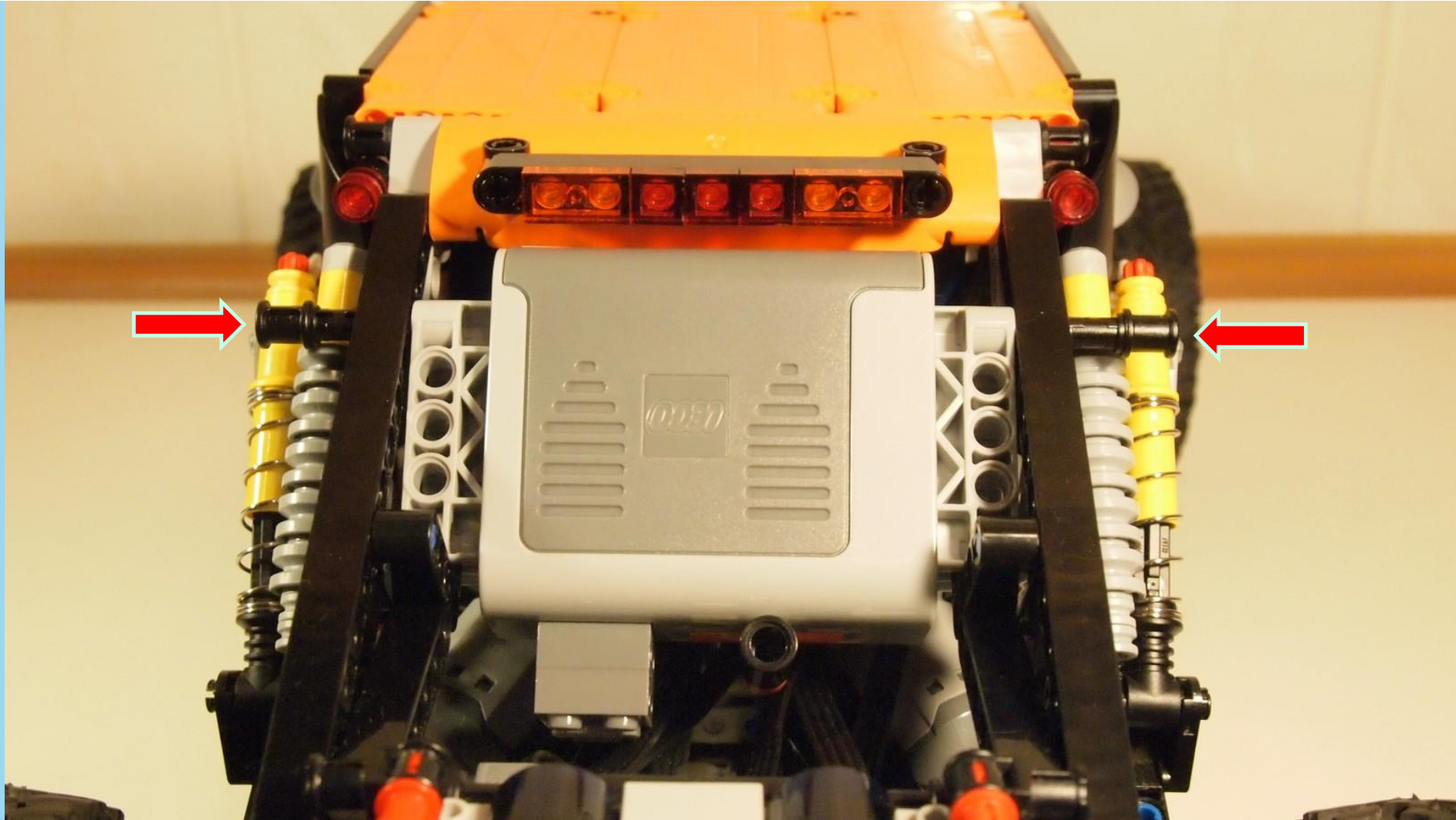



2x



1x



1x



1x



1x

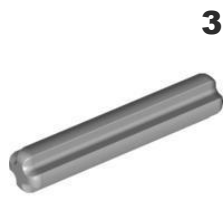

2x

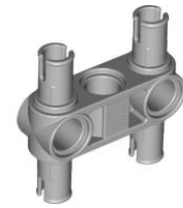

1x



1x



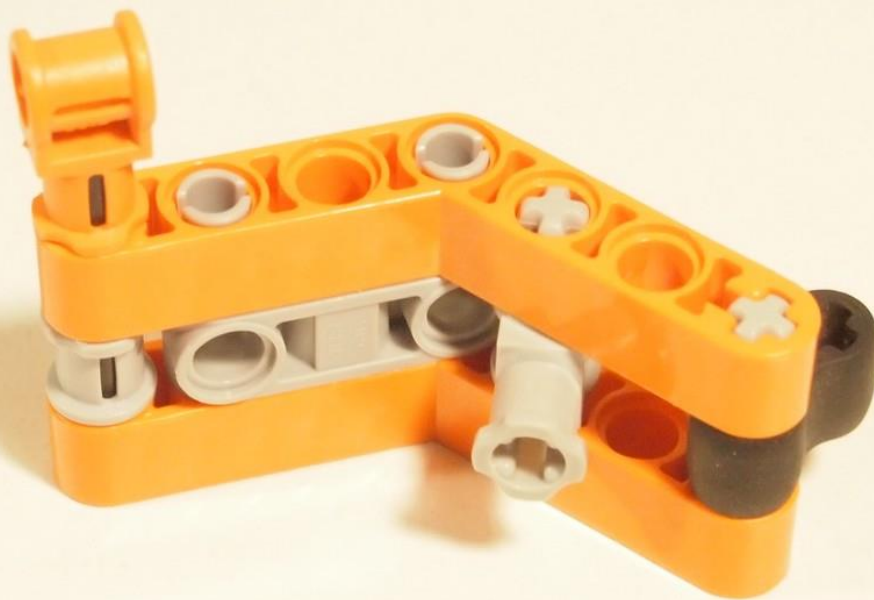



1x



2x



4x



1x



1x



1x



1x



1x



2x



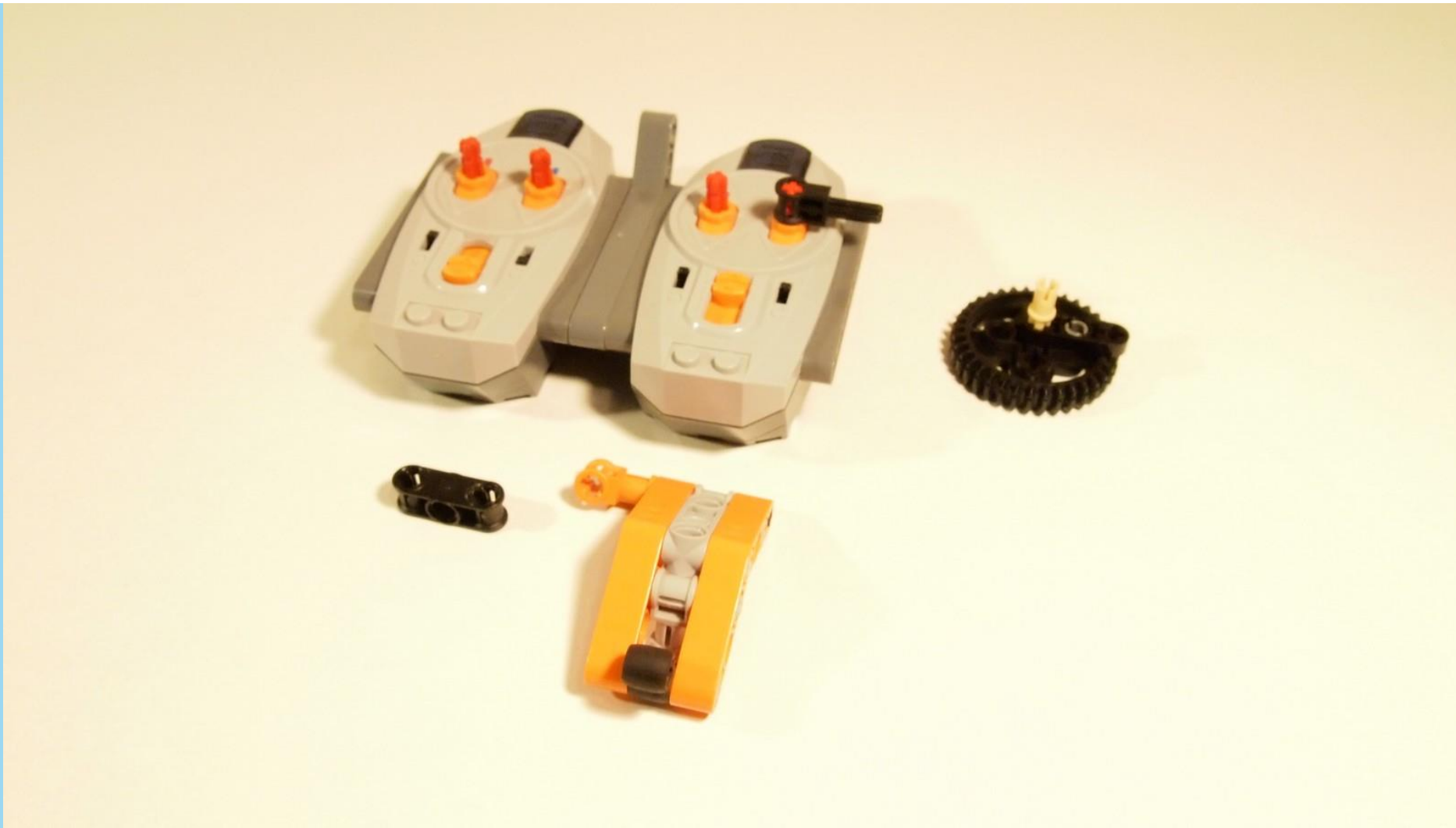



Check if the wheels rotate in same direction in hand first!



havefun!

[visit my Bricksafe profile](#)



unimogwheels



tryinothercolors

This is a free document - should not spread for money!

